

626863 REOVIB MFS 268

Frequency controllers for vibratory feeders



Operating instructions



IP 54 protected stand-alone units

Features

Feeder operating frequency is adjustable and independent of mains frequency.
Constant feed rate ensured by internal compensation, irrespective of mains fluctuations.
Integrated track control via backlog sensor.
24 V DC output for operating an air valve (IP 54 version), and amplitude control (sensor required).
Independent resonant frequency search possible for feeder.
Enable input (start / stop), status relay (output active / inactive).
Stand-alone housings (IP 54) or panel-mounted units (IP 20).

Technical data:

Supply voltage	110 / 240 V, +/- 10%, 50/60 Hz
Output	0...100 / 0... 205 V, 12 A
Output frequency	5...300 Hz, (preset at 35... 140 Hz)
Enable input	Contacts or 24 V, DC
Track sensor	24 V, PNP (100 mA)
Solenoid air valve output	24 V, 150 mA
Status output relay (ON/OFF)	Changeover contact (250 V, 1 A)
Operating temperature	0...+45 °C
Storage temperature	-10...+80 °C
Recommended fuse	16 A slow-blowing, Type 'D' MCB

Display and controls



- Increase value
- Decrease value
- Return
- Programming mode or Enter

Instructions:

Menus are used for changing settings. The different parameters are selected by entering a code.

All adjustments are made by first pressing the P key, followed by selecting the menu code, using the cursor keys.

Settings

Pressing the cursor key for a short time causes one digit increase/decrease, holding down for a longer time gives changes in ten-digit steps.
Changed settings are saved when exiting the menu or automatically if a key is not pressed for 60 seconds.

Operating displays

- Enable OFF
- Track full
- Setpoint in %
- Stop using "0" key

Safety instructions

This description contains the necessary information for the correct application of the product described below. It is intended for use by technically qualified personnel. Qualified personnel are persons who, because of their training, experience and position, as well as their knowledge of appropriate standards, regulations, health and safety requirements and working conditions, are authorised to be responsible for the safety of the equipment, at all times, whilst carrying out their normal duties and are therefore aware of, and can report possible hazards (definition of qualified employees according to IEC 364).

 **WARNING!**
Hazardous voltage!

Failure to observe can kill, cause serious injury or damage.
Isolate from mains before installation or dismantling work, as well as for fuse changes or post installation modifications.
Observe the prescribed accident prevention and safety rules for the specific application.
Before putting into operation, check if the rated voltage for the unit conforms with the local supply voltage.
Emergency stop devices must be provided for all applications. Operation of the emergency stop must inhibit any further uncontrolled operation.
Electrical connections must be covered.
Earth connections must be checked for correct function, after installation.



Declaration of conformity







We declare that these products conform with the following standards and directives:
EN 61000-6-4 and EN 61000-6-2 in accordance with directive 89/336/EEC.







REO ELEKTRONIK AG, D-42657 Solingen

Specified use

The units described herein are electrical controllers for installation in industrial plants. They are designed for power adjustment on vibratory feed equipment.

Installation

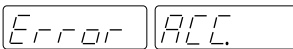
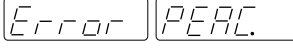
	Check!	Do supply voltage, operating voltage of the conveyor and controller input voltage match ? Is the controller adequately rated for the rated power of the feeder ? What is the vibrating frequency of the feeder ?
	Fuses	During switch-on, internal capacitors cause a high inrush current. Especially if several controllers are switched on simultaneously, the external fuse can blow or the circuit breaker can trip. Therefore, we recommend fitting slow-acting fuses or circuit breakers, e.g. with type 'D' characteristic.
Connect the unit in accordance with the wiring instructions and ensure that earthing is correct !		
	Attention!	New units are factory set (see table with settings). For units with unknown settings, first recall the factory settings using Menu C 210 'FAC'.
	External setpoint	If an external setpoint source is used, select "E.S.P." = I in Menu C003. If a potentiometer is used, select also 'Pot.' = I. To set the minimum vibration level, select E.S.P. = 0, adjust the vibration level with the cursor keys and then set E.S.P. = I.
	Settings	The specific settings for a system can be saved by selecting 'US.PA.' in Menu C143 (recall settings via Menu C 210 'US.PA'). Menu access can be hidden by selecting 'Hd.C.' = I in Menu C117.

Settings	Range	Code	Factory settings	Menu code	Error messages
Amplitude (feed rate)	0... 100 %	A.	0 %	000, 002	 Overload (output current too high). Possible cause: Feeder too large, frequency too low for installed coils, air gap too large.
Maximum output voltage	5...100 %	P	90 %.	096, 008	
Vibrating frequency	35...140 Hz	F.	100 Hz	096, 008	 Short-circuited output Possible cause: Incorrect wiring, possibly a defective coil.
Soft start ramp up	0... 60 sec.	/.	0.1 sec.	096	
Soft stop ramp down	0... 60 sec.	\.	0.1 sec.	096	 Input voltage too high Cause: Mains voltage too high or induced voltage from coil
External setpoint	0 / 1	E.S.P.	0	003	
Potentiometer setpoint	0 / 1	POT.	0	003	 Sensor timeout has elapsed (material sensor)
Setpoint 0(4)... 20 mA	0 / 1	0	4.20	003	
Coarse / Fine control	0 / 1	2.SP.	0	003	 Sensor fault (only in regulation mode) Accelerometer missing or faulty
Invert enable	0 / 1	-En.	0	003	
Switch on time delay	0... 60 sec.	l.	1.0 sec.	007, 167	 Current spike limit Frequency set too low for installed coil or frequency altered too rapidly during setting up
Switch off time delay	0... 60 sec.	o.	1.0 sec.	007, 167	
Invert sensor	PNP/PNP invers	-SE.	PNP	007, 167	Error messages must be cleared in Menu no. C 009 by means of 'Cl.err.' 
Activate sensor timeout.....	0 / 1	E.En.	0	015	
Sensor timeout delay	1... 240 sec.	E.	180 sec.	015	Timeout can be cleared with the 'I' key or by means of enable 
Switch off time air valve	0...60 sec.	Ai.	4 sec.	015	
Activate control mode	0 / 1	ACC.	0	008	Frequently appearing Errors, which are not described in this chapter, should be reported to the manufacturer.
P characteristic	0...100	P.A.	40	008	
I characteristic	0...100	I.A.	100	008	
Automatic frequency control ON	0 / 1	A.F.C.	0	008	
Automatic frequency search ON	0 / 1	A.F.S.		008	
Display output current		i.		040	
Display output frequency		F.		040	
Pulse feed	0 / 1	HOP.	0	064	
On time delay (only if HOP = I)	0..60 sec.	H.	1.0 sec.	064	
Off time delay (only if HOP = I)	0..60 sec.	h.	1.0 sec.	064	
Invert Hopper sensor (not active)	0 / 1	-Ho.	0	064	
Save user settings		PUSH.		143	
Restore factory settings		FAC.		210	
Restore user settings		US.PA.		210	
Hide programming menus	0 / 1	Hd.C.	0	117	
Hide setpoint adjustment	0 / 1	di.S.	0	137	
Display software version				001	

No code number is required to change the feed rate: pressing the P key twice will call the setpoint display.

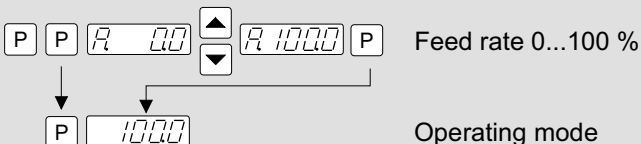

Code 000 Feed rate set point

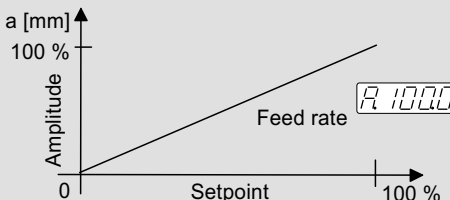

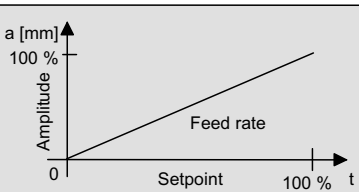
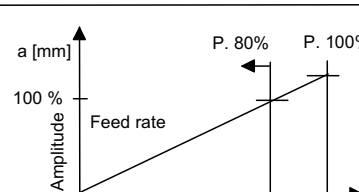
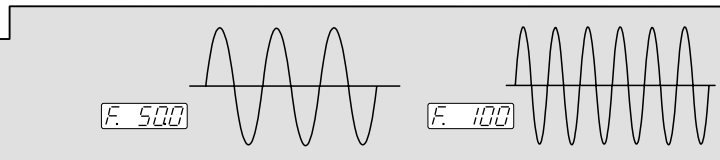
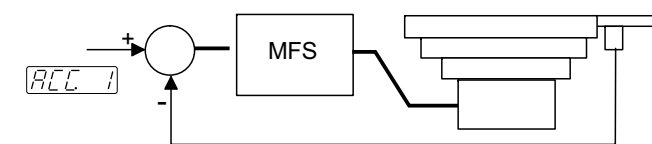
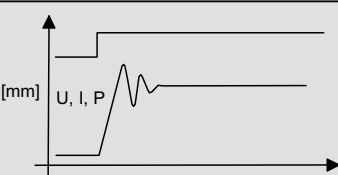

Feed rate setting

<h3>Code 003 Function settings</h3>	<p>Display: ESP. 0, R. 1000</p> <p>0...+10 V: ESP. 1</p> <p>0(4)...20mA: ESP. 1, 420. 1</p> <p>Potentiometer: ESP. 1, POT. 1</p>	<ul style="list-style-type: none"> Internal using keys in touch panel External setpoint 0...+10 V, 0(4)...20 mA Potentiometer 10 KΩ 	<p>Set point input</p>
<p>P [ESP. 0] [ESP. 1] P</p> <p>0 = Setpoint using display I = external setpoint 0...+10 V ON</p> <p>P [420. 0] [420. 1] P</p> <p>0 = external setpoint 0...+10 V I = external setpoint 4...20 mA</p> <p>P [POT. 0] [POT. 1] P</p> <p>0 = 0...10 V / 0(4)...20 mA I = Potentiometer</p>		<ul style="list-style-type: none"> Track control or Coarse / fine control with two feed rates 	<p>Sensor input</p>
<p>P [SP2. 0] [SP2. 1] P</p> <p>0 = Track control via backlog sensor I = Coarse/fine control with second setpoint</p> <p>P [-En. 0] [-En. 1] P</p> <p>0 = Enable I = Invert enable</p>		<ul style="list-style-type: none"> +24 V signal or closed contact will enable the output. +24 V signal or closed contact will inhibit the output. 	<p>Enable input</p>
<p>P [1000]</p> <p>Operating mode</p>			
<h3>Code 096 / 020 Feeder</h3>		<p>Limiting the maximum feed rate</p> <p>The set point will still display 0... 100 %, even though it is limited internally.</p>	<p>Maximum feed rate</p>
<p>P [C. 000] [C. 096] P</p> <p>P [R. 00] [R. 100] P</p> <p>Feed rate 0...100 %</p>			
<p>P [R. 1000] [R. 900] P</p> <p>Maximum limit 100...5 %</p>		<p>The frequency setting depends on the feeder type.</p> <p>Important! The wrong frequency setting can damage the coil.</p>	<p>Vibrating frequency</p>
<p>P [F. 500] [F. 480] P</p> <p>Vibrating frequency [Hz]</p> <p>P [T. 00] [T. 40] P</p> <p>Soft start time 0...5 sec.</p> <p>P [L. 00] [L. 40] P</p> <p>Soft stop time 0...5 sec.</p>		<p>Time ramp for starting and stopping the feeder.</p>	<p>Soft start / soft stop</p>
<p>P [1000]</p> <p>Operating mode</p>			

Code 008 Control mode					
<p>P C 000</p> <p>P R 00</p> <p>P P 1000</p> <p>P F 500</p> <p>P ACC 0</p> <p>PR 10</p> <p>IR 10</p> <p>ACC 0</p> <p>RF5</p> <p>P 1000</p>	<p>C 008</p> <p>R 100</p> <p>P 900</p> <p>F 480</p> <p>ACC 1</p> <p>PR 10</p> <p>IR 10</p> <p>ACC 1</p> <p>RF5</p>	<p>Feed rate 0...100 %</p> <p>Maximum limit 100...5 %</p> <p>Vibrating frequency [Hz]</p> <p>Switch to control mode 0 = Regulation (without sensor) 1 = Control (with sensor)</p> <p>Proportional characteristic (gain)</p> <p>Integral characteristic (damping)</p> <p>Automatic frequency control 0 = Off 1 = On</p> <p>Start frequency search</p> <p>Operating mode</p>	     	<p>Limiting of output voltage or feed rate, e.g. to prevent hammering. The displayed setpoint range remains at 0...100%.</p> <p>Frequency setting depends upon the feeder type.</p> <p>Activates the control mode to ensure a constant vibration amplitude, even with large load variations. The control mode requires an acceleration sensor.</p> <p>Influences the regulation behaviour: Lineout time and vibration behaviour (pumping) of feeder.</p> <p>Automatic frequency change in case of resonance.</p> <p>Start automatic frequency search</p>	<p>Maximum feed rate</p> <p>Vibrating frequency</p> <p>Control mode</p> <p>Control parameters</p>
		<p>▲ key will start automatic frequency search</p>			

Amplitude-controlled operation requires an acceleration sensor mounted to the feeder, e.g. SW11. Ensure that sensor is mounted rigidly (no self-oscillation), and that feeder is standing firmly.

Manual adjustment of vibrating frequency

Frequency adjustments must be made with a low setpoint (e.g. 30 %), because at the resonant frequency, large oscillations (coil hammer) can occur with relatively low output voltages. To determine resonant frequency, an analog true-rms current meter (e.g. moving-iron instrument) must be connected in the output circuit. Resonant frequency is found when a minimum output current produces maximum vibration amplitude.

Automatic frequency search (only with controlled operation)

- * Adjust setpoint to zero.
- * Activate control mode (Menu C 008, set Parameter ACC = 1).
- * After starting the frequency search (Menu C 008, select Parameter 'A.F.S.', and start with the arrow key), the optimum vibration frequency of the feeder will be determined. When the resonant frequency has been found, the controller switches back to normal operation.

Note:

If coil hammer occurs during the frequency search, Parameter 'P.' in Menu C008 must be reduced.

Code C 007 / C 167 Track control / Backlog sensor

P C.000 C.167 P

P 1.00 1.50 P

Switch on time delay
0...60 sec.

P 0.00 0.50 P

Switch off time delay
0...60 sec.

P -SE.0 -SE.1 P

Invert sensor function
I = inverted

P 1000

Operating mode

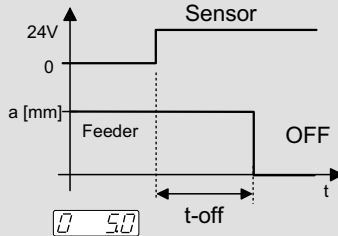
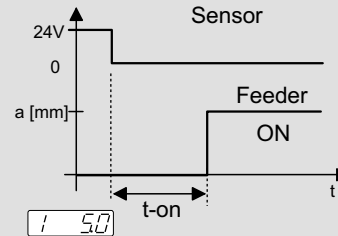

Adjustment of the ON and OFF delays

Time delays

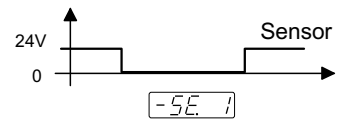
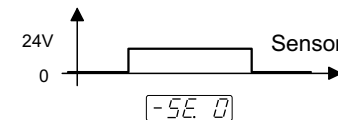

Invert sensor input

Sensor

Code 015 Special functions

P C.000 C.015 P

P EE.n.0 EE.n.1 P

0 = Feeder doesn't switch off during timeout
1 = Feeder switches off during timeout

EE.n.0 inactive
EE.n.1 active

P E.40 E.1800 P

E. = Sensor timeout [sec]

P Rl.0 Rl.10 P

Run-on-time for air valve output

P 1000

Operating mode

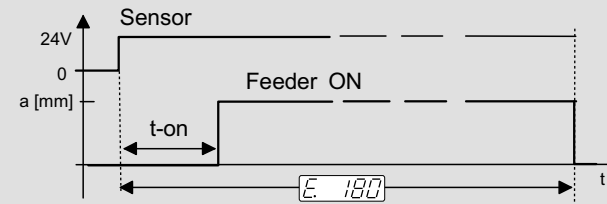

Sensor control active.
If no components are detected during the timeout period, the feeder switches off.

Sensor control

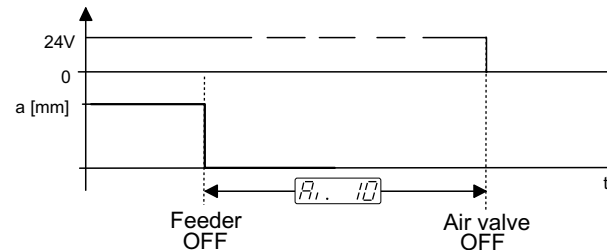

Setting the run-on-time for the air valve output.

Air valve output

Code 064 Pulse feed

P C.000 C.064 P

P HOP.0 HOP.1 P

0 = Pulse feed Off
1 = Pulse feed On

P H.10 H.500 P

Feeder on time

P h.10 h.315 P

Feeder off time

P -HQ.0 -HQ.1 P

Sensor invert (not active)

P 1000

Operating mode

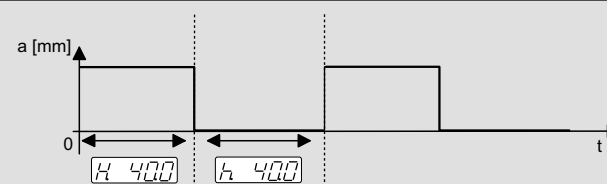

On and Off time for Hopper pulse feed

Pulse feed

Code 117 Inhibit access



I = Hidden menus

Hdc.1

Parameter menus cannot be accessed, except for the feed rate setpoint

Hdc.0

Parameter menus can be accessed

Hide programming menus.

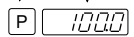

Operating mode

Code 137 Inhibit setpoint access



0 = Setpoint access ON
1 = Setpoint access OFF

d1.5.0

Setpoint can be adjusted

d1.5.1

Setpoint cannot be adjusted

Setpoint access

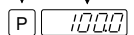

Operating mode

Code 143 Save parameter settings

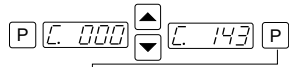

Select parameters 0 to 3

Saves up to 4 different parameters (no. 0 - 3).

Save parameter settings



Save parameter settings

▲ All previously set parameters are saved.

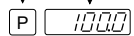

Operating mode

Code 210 Restore parameters

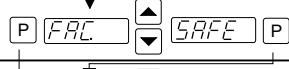

Restore factory settings

▲ Restore factory settings.

Restore factory settings



Select parameters 0 to 3

Saves up to 4 different parameters (no. 0 - 3).

Restore parameter settings previously stored under C143



Restore user settings

▲ Restore settings saved under C143.

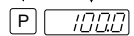

Operating mode

Service

Code 127 Enable service menu

P C. 000 ▲ C. 127 P
P EnS. 0 ▲ EnS. 1 P 0 = Service mode OFF
P 1000 Service mode 1 = Service mode ON

EnS. 1	Enables access to the adjustment of I _{max} , F _{min} / F _{max} , and Output voltage limiting.	Extended settings	Service
---------------------	---	-------------------	---------

Code 040 Service

P C. 000 ▲ C. 040 P
P I. 385 P Actual value in % (display only) of the nominal coil current
P I. 1000 ▲ I. 800 P Current limit in % of I_{max}.
P F.L. 35 ▲ F.L. 30 P Lower frequency limit
P F.H. 120 ▲ F.H. 80 P Upper frequency limit
P F. 505 P Actual frequency value (display only)
P PLI. 0 ▲ PLI. 1 P Output voltage limiting 100 V
P 1000 Operating mode 0 = Off, 1 = On

I. 385	Display shows the actual coil current in % of the nominal current (I _{nom}).	Conversion $\frac{\text{Display} \times I_{nom}}{100} = \frac{38,5 \times 6}{100} = 2,31 \text{ A}$	Monitoring the output current.
I. 800	Adjustment of the current limit in % of the nominal current (I _{nom}).	Conversion: e.g. 4,8 A coil: $\frac{I\text{-limit} \times 100}{I_{nom}} = \frac{4,8 \times 100}{6} = 80 \%$	Adjusting output current limit depending on coil.
	Adjustable frequency range Parameters 'F.L.' and 'F.H.' in Menu C 040. Effective frequency range Parameter 'F' in Menus C 008, C 096, and C 020.		Setting the limits of the frequency adjustment range accessible for the user. A narrow adjustment range is preferable for the automatic frequency search function.
F. 505	Display shows the actual vibration frequency.		Monitoring the vibration frequency
PLI. 1	When operated with 230 / 240 V mains supply, the output voltage is limited to 100 V.		

Electrical connections
Stand-alone housing version

REOVIB MFS 268 IP 54

Depending on version, various different electrical connections are used.

Standard version

Mains cable entry, and power output socket

4-pin M12 socket for track control sensor (backlog)

4-pin M12 socket for amplitude sensor (accelerometer)

An additional cable entry gland can be fitted for connecting the 'Enable' and/or 'Status' signal.

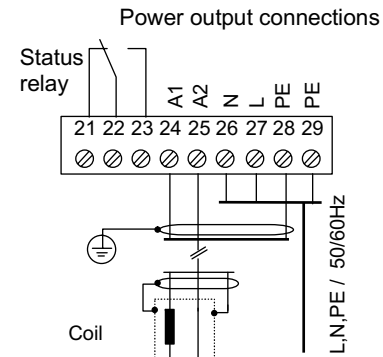
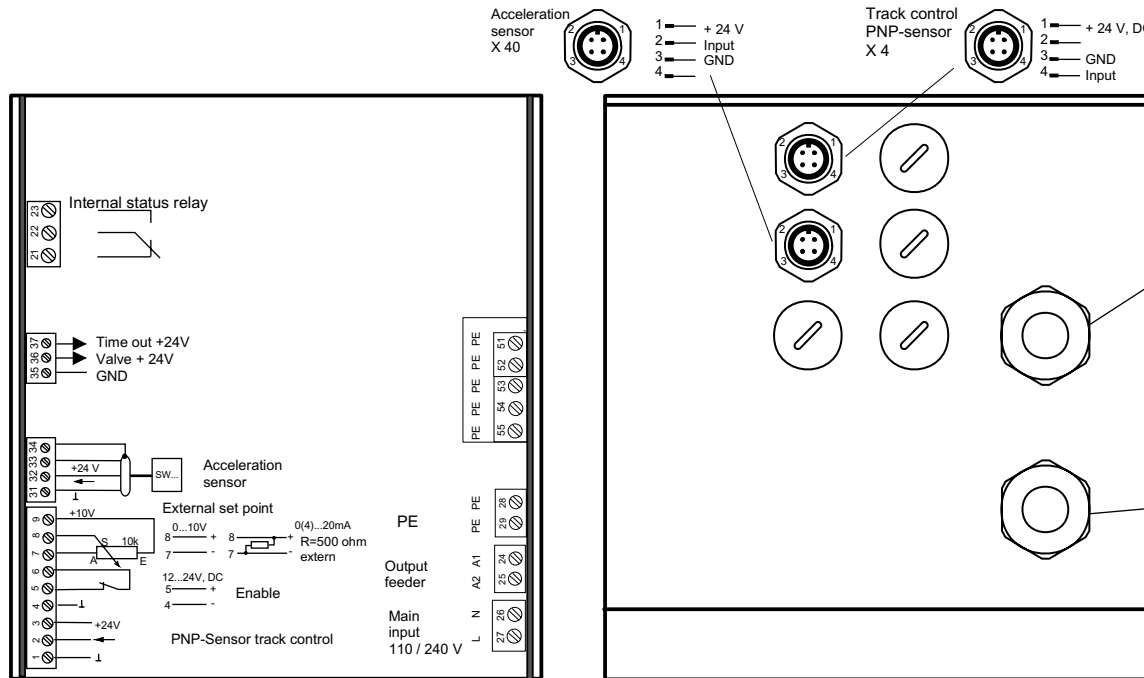

Dimensions

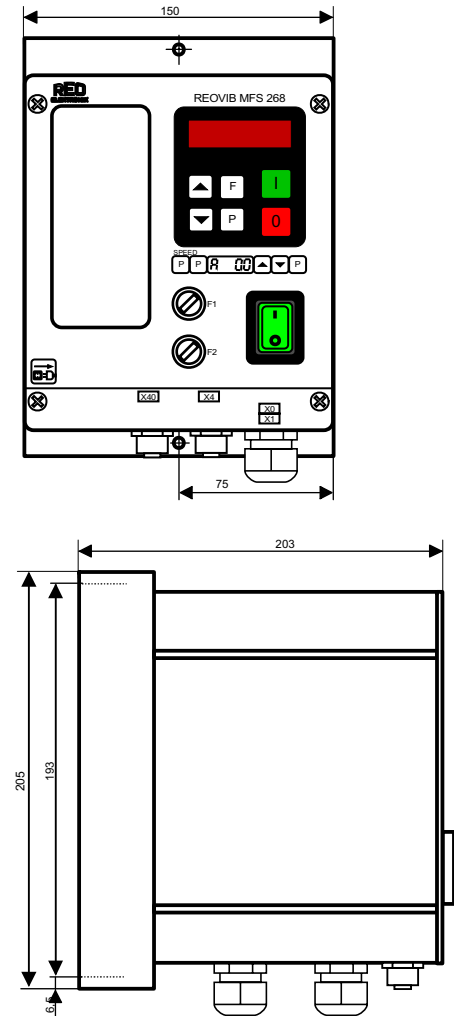

Ordering codes for plugs:

Output plug: Power output socket 3+PE
 Track sensor: 4-pin M12 plug
 Amplitude sensor: 4-pin M12 plug (screened)

HA-4-M / 090212
 RSV-M12-4 / 090131

Ordering codes for plugs:

Supply voltage:
 Output:
 Track control, Enable, status relay sensors:
 Air valve control sensor:

Power output socket 3+PE
 Power output plug 3+PE
 4-pin M12 plug
 4-pin M12 plug

HA-4-M-F / 090218
 HA-4-M / 090212
 RSV-M12-4 / 090131
 RSV-4 / 090104