

# Power-frequency magnetic field immunity test

## Testing and measurement techniques

REO INDUCTIVE COMPONENTS AG  
Bruehler Strasse 100, D-42657 Solingen, Germany  
Tel: 00 49-(0) 2 12-88 04-0  
Fax: 00 49-(0) 2 12-88 04-188

REO USA  
8432 East 33rd Street, Indianapolis  
IN46226-6550, USA  
Tel: 001 317 8991395 Fax: 001 317 8991396



<b>Power-frequency magnetic fields</b>	<b>2</b>
<b>What to test?</b>	<b>3</b>
<b>Shielding is usually impractical or costly</b>	<b>5</b>
<b>What levels of power-frequency magnetic fields occur?</b>	<b>6</b>
<b>Fully compliant 50Hz magnetic field immunity tests</b>	<b>7</b>
<b>Do-it-yourself power-frequency magnetic field immunity testing</b>	<b>14</b>
<b>On-site testing of power-frequency magnetic field immunity</b>	<b>15</b>
<b>Alternative test generators</b>	<b>15</b>
<b>Conversion factors</b>	<b>16</b>
<b>References</b>	<b>17</b>
<b>The Author</b>	<b>18</b>

The basic power-frequency magnetic field immunity test method is IEC 61000-4-8 [1]. This has been adopted as the harmonised European standard EN 61000-4-8, which is often called up as a basic test method by immunity standards listed under the Electromagnetic Compatibility (EMC) Directive [2].

This handbook describes how to apply EN/IEC 61000-4-8. Unlike many EMC tests, it is easy and low-cost to 'do-it-yourself'.

Since magnetic fields can interfere with a variety of electrical and electronic devices, equipment and systems (called products in the rest of this handbook), it makes sense to test them to ensure they will work correctly in their intended operating environment. This is especially important in safety-related electronic applications.

Magnetic fields at power-line frequency (50 or 60Hz) are ubiquitous, with high field strengths experienced close to power cables, transformers, electric motors, or close to heavy power distribution or use (e.g. underneath overhead distribution cables). Load switching causes step-changes ('pulses') in the levels of power-frequency magnetic fields, and electrical faults can cause much higher field strengths to exist until a fuse or circuit-breaker opens to protect the affected circuit from damage.

Most applications are also exposed to magnetic fields at other frequencies, or with other pulse characteristics. For example, electronic equipment and

household appliances often consume harmonic current from the mains supply - leading to significant levels of magnetic fields at harmonics of the mains frequency, emitted by the equipment/appliances and the mains distribution that supplies them. In some environments the levels of fields at the third harmonic can be between 30 and 115% of the levels at the fundamental frequency [5]. Some environments can suffer from powerful magnetic fields at frequencies up to 1MHz (e.g. induction heating, high-street shop theft protection systems), and some products are exposed to high levels of pulsed magnetic fields from lightning strikes to building lightning protection systems (with rise-times of 1µs or less).

However apart from professional audio equipment and systems there are no IEC or EN basic test methods for immunity to magnetic fields other than at the fundamental power-line frequency.

Professional audio equipment and systems are often exposed to powerful magnetic fields at audio frequencies, often from loudspeaker amplifiers and their leads. Their product family. EMC immunity standard EN 55103-2 [3] under the EMC Directive uses a test method derived from a military EMC standard to test for immunity to magnetic fields from 10Hz to 10kHz.

The EN/IEC 61000-4-8 or EN 55103-2 methods could be used to test products with magnetic fields at much higher frequencies, as long as their induction coil diagonal or diameter is less than one-twentieth of the wavelength. High field strengths at high frequencies are limited in practice by the high levels of voltage drive that would be required.



### Examples of items that are sensitive to external magnetic fields

Oscilloscopes, medical monitors, etc (using CRT displays)



PC monitors (traditional CRT types)  
PC hard disc drives  
PC floppy disc drives

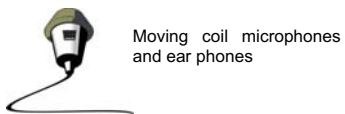

Moving coil microphones and ear phones



TV's (traditional CRT type)



Video & tape recorders and players

Electric guitars



Loudspeakers

At the time of writing, the EMC Directive's generic and product-family immunity standards that call up EN 61000-4-8 only apply it to products that contain magnetically sensitive components, such as cathode-ray tubes (CRTs, e.g. computer monitors, TVs), electron-multiplier tubes, moving-coil microphones, microphone transformers, hall-effect sensors, magnetic recording/playback, loud-speakers and the like.

But it is not only magnetically sensitive parts which can suffer interference from power-frequency magnetic fields. All signal currents travel in loops, and these loops enclose an area which will pick up magnetic fields in their environment to create interfering voltages.

An important example concerns printed circuit board (PCB) layouts. For example, if the current path of a wanted signal enclosed a loop area of 100cm<sup>2</sup> (e.g. a square 10cm on each side) exposure to a 50Hz magnetic field of 3A/m will add a noise voltage of 1.2µV to the wanted signal. This small voltage is enough to compromise low-level signals - especially if a high signal-to-noise specification is required. The levels of power-frequency magnetic fields that can be caused by adjacent items in a rack or test equipment have sometimes been found to cause modulation sidebands in the outputs of signal generators, and spurious tones in the demodulated signals from FM/PM modulation analysers.

Similar calculations can be applied to the loop area enclosed by a signal conductor in a cable and its associated return, and is the reason why twisted-pair cables are so often recommended for audio and low-level signals - the regular twisting cancels out the majority of the induced voltage from the magnetic field.

For a single current loop, in air:  
 $V_n = 2 \cdot \pi \cdot f \cdot \mu_0 \cdot H \cdot A$   
 where  
 $V_n$  is the noise voltage created (in Volts rms)  
 $f$  is the frequency of the magnetic field (in Hertz)  
 $\mu_0$  is the permeability of free space ( $4\pi \cdot 10^{-7}$ )  
 $H$  is the rms value of the magnetic field strength (in A/m)  
 $A$  is the area of the loop enclosed by the signal's current (in m<sup>2</sup>).

### Voltages induced in a PCB Circuit by an external AC magnetic field

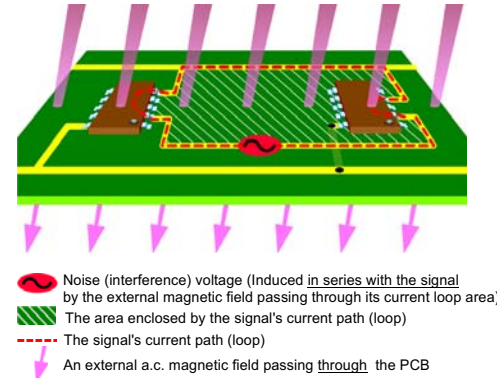

Less commonly occurring equipment such as electron microscopes, and certain types of medical instrumentation, can be very sensitive to power-frequency magnetic fields. For instance, measurements of evoked potentials (sometimes called evoked responses) in nerves would be impossible in the 1A/m field which is the lowest test level employed by EN/IEC 61000-4-8. This is because the cables to their patient electrodes cannot be twisted along their full length; so necessarily enclose large areas (at least 0.1m<sup>2</sup>); and also because nerve signals are measured in µV and the measuring bandwidth goes up to at least 60Hz. Since it is impractical to wrap the patient and electrode leads in mumetal, such applications require environments with very low levels of power-frequency magnetic fields - not easy to find in modern hospitals.

It is worthwhile remembering that - like all 'CE marking' Directives - the EMC Directive has two separate legal requirements that must be met for a product's conformity to be achieved:

- 1 The EMC conformity assessment
- 1 The EMC Protection Requirements

Statements about both of these are required on the Declaration of Conformity which is signed by a company's Technical Director (or someone with similar authority).

The EMC conformity assessment is usually achieved by applying all of the relevant standards listed under the EMC Directive. A listing under the EMC Directive means that complying with that standard provides a 'presumption of conformity' for the EMC issues it covers.

But a 'presumption of conformity' is only a presumption and not a *guarantee* of conformity. The EMC Protection Requirements require that a product does not cause or suffer from unacceptable interference when used in its intended environment. EMC standards only cover a limited range of interference types and 'typical' environments, and some of the standards are well-known to be inadequate for the modern environment, so there is always the possibility that simply meeting all the relevant standards will not create a compliant product. This issue is specifically recognised in the upcoming 2<sup>nd</sup> Edition EMC Directive, which will require manufacturers to perform an 'EMC risk assessment' to determine what EMC tests are relevant for each of their products.

In any case, few manufacturers want to risk the warranty costs and bad market image created by an unreliable or interference-prone product, so it is recommended that the magnetic field environment of a product is assessed and suitable testing applied to ensure the desired level of product quality.





## Shielding is usually impractical or costly

5

A magnetic field induces a voltage in series with a current loop path, almost regardless of the circuit's impedances or the resistances of the conductors. The only low-cost solution that will significantly reduce the level of an interfering voltage induced by a power-frequency magnetic field, is to reduce the area enclosed by the respective signal's current path. Unfortunately, most PCB designers aren't used to thinking about current paths and their enclosed loop areas, so this aspect of PCB layout is often ignored.

The only other method is shielding, but using ordinary materials is impractical. 3mm thick mild steel only reduces a 50Hz field by about 20dB, and it takes about a 25mm thickness of aluminium to achieve the same modest shielding effectiveness. 'Mumetal' and other exotic high-permeability metals can be used to achieve better shielding of power-frequency magnetic fields - at a price - however it is sometimes used to shield CRTs and other magnetically sensitive components whose current loop areas cannot be reduced.

So it can be argued that every new product that utilises small analogue signals and/or high gains should be tested using EN/IEC 61000-4-8, at least during development, to check that the expected power frequency magnetic fields in its operating environment won't cause signal-to-noise or reliability problems in the field.

Where the likely magnetic fields (continuous or pulsed) in an environment are larger than 30A/m, and/or where interference could possibly result in functional safety problems, it can be argued that *all* products using analogue signals (and maybe some digital products) should be tested using EN/IEC 61000-4-8 at the appropriate test levels.

## What levels of power-frequency magnetic fields occur?

6

Annexe D of EN/IEC 61000-4-8 [1] gives some useful information on the power-frequency magnetic field strengths likely to occur in various locations. 100 household appliances were tested (25 basic types) to find that at 300mm distance the field was most likely to be between 0.03A/m and 10A/m, although a field of 21A/m was measured in at least one case. At 1.5m distance the highest field was 0.4A/m. Other sources of information on the magnetic field that may be found in real environments include IEC 61000-2-7 [6] and Cenelec R014-001:1999 [7].

The fields from small sources such as motors or transformers reduce rapidly as the distance from the source increases, as shown by the above examples. But the magnetic fields created by electrical power distribution often reduce at a lower rate. At ground level directly below a 400kV overhead power line the field strength is typically 16A/m per kA of line current, whereas at 30m sideways from the centre of the path of the overhead line it is about 5A/m per kA of current.

At floor level in a building with underfloor electric heating, or at ground level above buried 400kV power cables, fields have been measured at 160A/m. 1kA/m or more has been measured in some locations in some electric railway rolling stock. 15kA/m has been measured in some industrial electrolytic processes (a field strength which exceeds health and safety guidelines).

Pulsed power-frequency magnetic fields are commonplace, and occur whenever a mains load is switched on or off. With

some product designs using ac-coupled circuits or adaptive software, continuous (steady) power-frequency magnetic fields in their operating environment might not cause an interference problem, but sudden changes in the magnetic field could present problems.

EN/IEC 61000-4-8 generally suggests testing with pulsed fields that are 10 times higher in amplitude than continuous fields, but in real life the maximum value of pulsed field depends upon the short-circuit current capability of the supply and the impedance of the electrical fault, which can be a lot more than 10 times the level of the normal continuous magnetic field.

EN/IEC 61000-4-8 also describes testing with continuous fields of 100A/m and pulsed magnetic fields of 1000A/m, or more. Such powerful fields are most likely to be experienced by apparatus exposed to magnetic fields from overhead or underground high-power LV or HV distribution cables, electric traction, electrical switchyards, electricity substations, or near mains distribution transformers. In these locations very high levels of pulsed fields can occur during the switching of heavy loads, and during faults in the supply network. A recent EMC specification from a major automotive manufacturer included the effect of the new electrically assisted steering that they intend to use in future vehicles, to replace traditional but inefficient pneumatically-assisted power steering. The high currents in the steering-assist motors and their cables can expose nearby electronic modules (including sensitive sensors) and their cables to fluctuating magnetic fields.





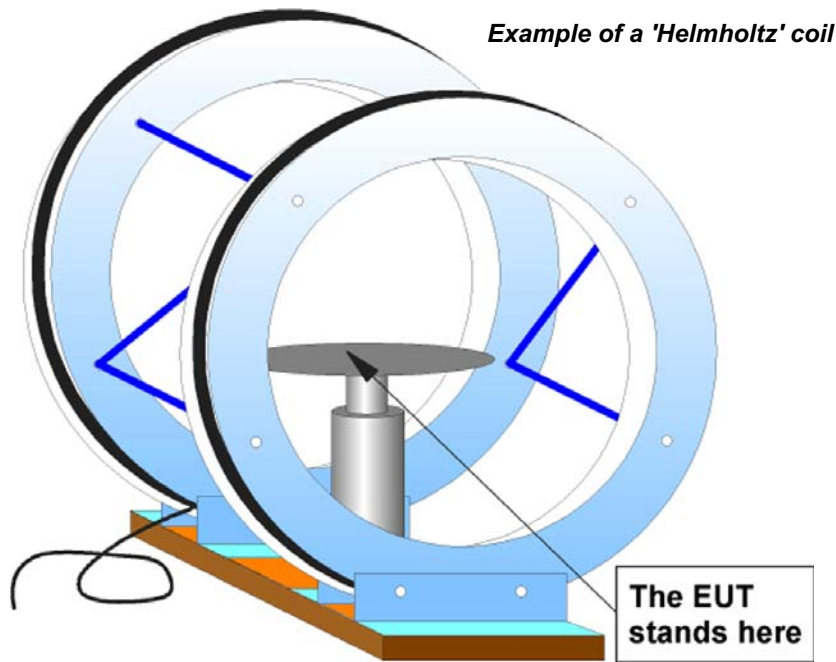

The test method immerses the equipment under test (EUT) in a power-frequency magnetic field created by an induction coil. Unlike many EMC test standards, EN/IEC 61000-4-8 is easy to understand and unambiguous. This handbook is a general guide - when testing you should always exactly follow the latest version of the standard.

Any suitable induction coil (or arrangement of coils) can be used, as long as it meets the requirements in EN/IEC 61000-4-8 for field uniformity and calibration. EN/IEC 61000-4-8 provides useful construction information on three kinds of coil (to cover three different sizes of typical EUT), so that most people will not need to design their own coils.

Helmholtz coils use two induction coils spaced apart to create a more uniform field over a larger volume than is possible with just a single coil. Some proprietary Helmholtz coils have three coil-pairs arranged tri-axially so that the three different field orientations can be tested by just selecting the coil to be driven with switches - no need to move the EUT or the coils.

Induction coils are calibrated by placing a suitable field-strength meter in the geometric centre of the coil, oriented for maximum reading. The induction coil is connected to the test generator using exactly the same set-up as will be used in the actual tests and the generator's output current to the coil is monitored. EN/IEC 61000-4-8 calls the ratio of magnetic field to drive current for a coil its 'coil factor' (although it would be more commonly recognised as its 'calibration factor' or 'transducer factor').

The specification in EN/IEC 61000-4-8 for the test generator is also very simple - it must be able to output sufficient sinusoidal current (with a maximum total distortion of 8%) to drive the induction coil and achieve the required field strength. A suitably rated transformer powered from an AC mains supply with reasonable quality is usually quite good enough. A suitable generator can consist of simply a variable transformer (to set the coil current and hence magnetic field level) and a high-ratio step-down transformer with an adequate secondary current rating. The step-down transformer should be a safety-isolating type and comply with the relevant part of EN/IEC 61558.

*A suitable test generator for EN/IEC 61000-4-8*

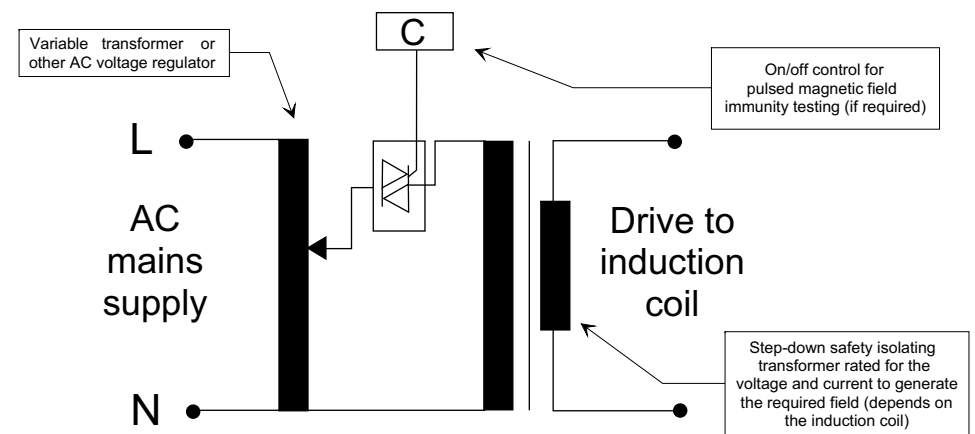



The formula  $V = N \cdot 2 \cdot \pi \cdot f \cdot \mu_0 \cdot H \cdot A$  allows calculation of the voltage required to drive a coil design to achieve the correct field strength, so that the correct type of step-down transformer can be purchased (or wound).

In this formula

$V$  is the voltage (in Volts rms) applied to the induction coil

$N$  is the number of turns in the coil (remember to double this for a Helmholtz type design)

$f$  is the frequency of the magnetic field (in Hertz)

$\mu_0$  is the permeability of free space ( $4\pi \cdot 10^{-7}$ )

$H$  is the rms value of the magnetic field strength required (in A/m), and  $A$  is the cross-sectional area of the coil (in square metres)

For example, driving a 10-turn induction coil of  $4\text{m}^2$  to achieve a 50Hz field of 30A/m requires a drive voltage of about 0.5V rms, and a



**Example of REOLAB 200 used as a regulated variable voltage source for the test generator**

A variety of continuous and pulsed field strength test levels are recommended in EN/IEC 61000-4-8, but the immunity standards which call up EN/IEC 61000-4-8 as their basic test method usually only require continuous field testing at 3A/m for domestic, commercial, and light industrial environments - and 30A/m for industrial environments.

However, for some products, especially those used in heavy electrical power environments, or very close to other equipment or power cables, reliability may require testing with field strengths beyond what is required by standards listed under the EMC Directive, and/or testing with pulsed fields.

So manufacturers may wish to test to these higher levels and pulsed fields to improve product quality, and specifiers may wish to specify the appropriate continuous and pulsed test levels from EN/IEC 61000-4-8 in purchasing contracts. The 'special test level' X may be specified where the operational environment could have stronger power-frequency fields than those listed in the standard.

### Example of a high-current step-down transformer from REO

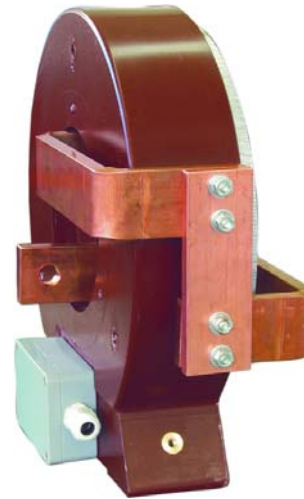

The secondary is a busbar with either half a turn (one pass through the toroid) giving a 0.8V output for a 230V input, or 1.5 turns (as shown) giving a 1.67V output.

Models with outputs up to 5kA (continuous rating) are available.

The maximum value of HA for 1.67V output is about 4000.

Eg. up to 100A/m for a  $20\text{m}^2$  single coil; up to 1,000A/m for a  $2\text{m}^2$  single coil; up to 4,000A/m for a  $1\text{m}^2$  single coil.

(Halve these fields for a Helmholtz type with two single coils)

Where programmable field strength levels are required remote-controlled variable transformers may be able to be used. Where the mains voltage is too variable, constant-voltage transformers or automatically self-regulating variable transformers may provide a solution.

But where mains supplies have a poor quality sinusoidal waveform or the wrong frequency (e.g. testing products intended for the EU market in China or the Philippines), the simple generator shown above might not suffice. Alternative test generators are discussed later.

Apart from the test generator and induction coil(s) the test instrumentation required is some means of measuring the coil current (which should have an accuracy of better than  $\pm 2\%$ ).

EN/IEC 61000-4-8 describes how to test table-top products and floor-standing products of any size. The EUT is placed over a ground reference plane (GRP) which is connected to the local safety earth system. GRPs must be made of a non-magnetic metal, ideally copper or aluminium, with a thickness of at least 0.25mm. Other (non-magnetic) metals used for the GRP must be at least 0.65mm thick. The minimum size of the GRP is 1 metre square and it must always extend beyond the EUT on all four sides.

The GRP may be used as one side of the induction coil although this means that to test using fields along all three axes in turn, one test must involve lying the EUT on its side which may not always be easy or desirable. Although the test set-up figures in EN/IEC 61000-4-8 show the GRP being used as one side of the induction coil, it is not a *requirement* of the standard.

In the case of table-top equipment, the EUT is placed in the centre of the coil (or coil arrangement) and spaced above the GRP with a 100mm thick insulating support, such as polystyrene or dry wood. If the EUT has a protective earth terminal this must be connected to the GRP.



The coils must be larger than the EUT on all sides, with a minimum spacing from the EUT of one-third the EUTs dimension in the plane of the coil, so that the EUT is immersed in a reasonably uniform field. But where the GRP is used as one side of the coil the spacing between GRP and EUT is specified as 100mm.

Auxiliary equipment required to operate the EUT in a realistic manner; signal and control cables; power supplies; loads and test equipment; should all be arranged so that the EUT can be fully exercised during the test and its functional performance monitored with sufficient accuracy to determine a pass or a failure.



**Examples of REO Loads - REO can create custom loads to meet any requirements**

All the EUT's cables are to be exposed to the magnetic field for 1 metre of their length, and if their induced noise voltages could cause problems for any auxiliary equipment or test gear they should be fitted with whatever filters are required to prevent this. These filters are called "decoupling networks" or "back filters" in the standard, and they need only 'notch out' the power-frequency (or frequencies) used by the test. These filters must have their grounds bonded to the GRP and have 1 metre of cable between them and the EUT.

**EN/IEC 61000-4-8's example test method for table-top equipment**

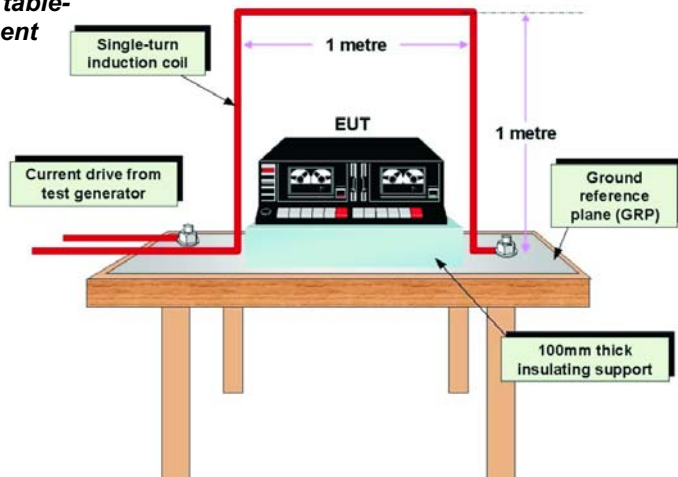

**Examples of REO filters REO can create custom filters to meet the EN/IEC 61000-4-8 requirements for "Decoupling network", "back filter"**



The fields from the induction coils extend for quite some distance, so it might be necessary to place the auxiliary equipment and/or test equipment some metres away to ensure they are unaffected. Sensitive equipment not associated with the test should be far enough away not to be interfered with. Don't forget that power-frequency magnetic fields pass easily through brick or plaster, and even through quite thick sheet metal, so it is important to consider what might possibly be on the other side of walls, floors or ceilings that are near to the induction coils.

The environmental conditions for the test are very easy to meet: temperature 15-30°C; relative humidity 25-75%; air pressure 860-1060millibars; and electromagnetic disturbances which are low enough not to influence the test results. The ambient power-frequency magnetic field strength must be less than one-tenth of the test level. This can be checked with the field strength meter used to calibrate the induction coil.

The relevant generic or product-family immunity standards, or operational reliability requirements, will set the test levels to be applied. The appropriate functional performance criteria should be decided upon before testing, so that the appropriate functional test arrangements can be provided for the test. Tests are performed with the coil (or coil arrangement) and the EUT arranged so as to test the EUT's response to magnetic fields in three orthogonal directions, usually front-back, side-side, and top-bottom.

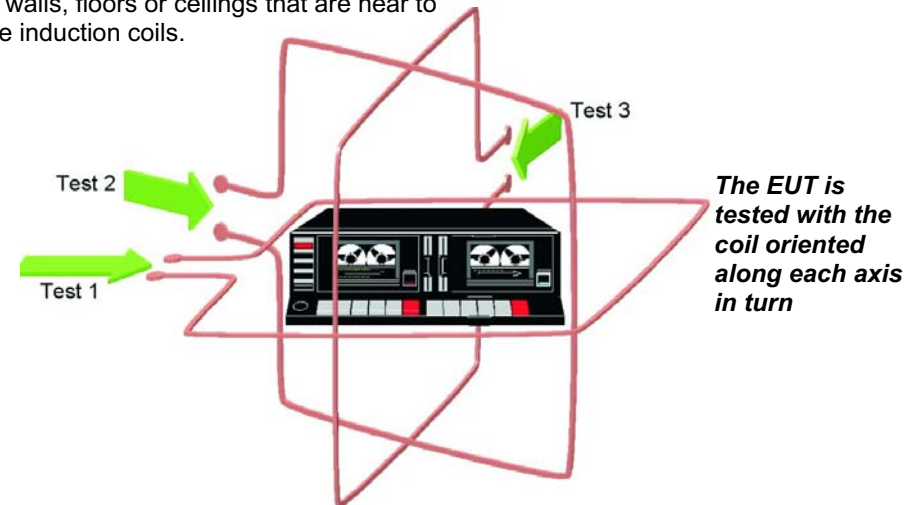





### A working example from REO of a test set up for magnetic field immunity

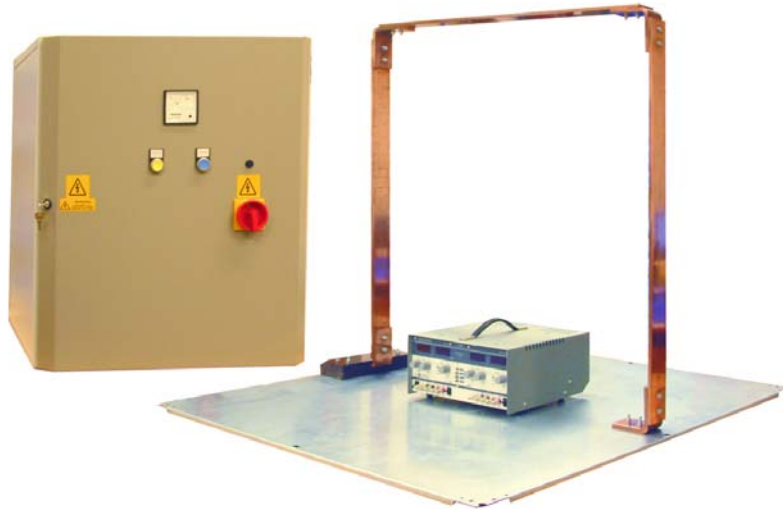

A coil arrangement suitable for immersing all of a large EUT in a test field with the  $\pm 3\text{dB}$  field strength specification of the standard may be too large and unwieldy for practical use. In such cases it is acceptable to use a single coil that is larger than the EUT (as described earlier) to immerse just a portion of the EUT in the specified field, repeating the test several times with the coil moved along the EUT each time, so that eventually the whole of the EUT (and 1m lengths of its interconnecting and power cables) have been tested.

The 'stepping' distance for the coil should be no more than 50% of the length of the coil's shortest side, to ensure an overlapping field coverage. To save testing time in such cases, smaller test coils can be used to identify the most susceptible areas of the EUT,

and the large coil then placed to immerse just those areas (or volume).

**Safety Note:** as a precaution, people fitted with heart pacemakers and/or similar implanted or body-worn medical devices should not be exposed to the magnetic fields generated by these tests.

A number of proprietary test instruments exist for full-compliance testing of magnetic field immunity according to EN/IEC 61000-4-8. Most (if not all) of these combine several types of immunity tests into one 'box' and some are sold with a basic set of test capabilities (usually EN 61000-4-2 and -4-4) to which additional testing 'modules' can be added (usually EN 61000-4-5, -4-8, -4-9 and -4-11).

The EN/IEC 61000-4-8 test method and basic test generator are so low-cost that it is difficult to find a lower-cost way of performing this test.

You can choose to add the EN 61000-4-8 test option to an all-in-one test instrument and this may not cost a great deal. But it is easy and low-cost to build your own test equipment to perform this test, and since it doesn't need a very special test environment (such as the anechoic chamber required by some immunity tests) it can be set-up in almost any 'electrically quiet' place, making it an easy test to do yourself.

The overall power requirements are not high and a variety of standard variable and step-down transformers may be used. If the heavy-gauge conductors and high currents required by single-turn induction coils are a problem, coils can be easily made using timber framing and standard gauge wire. For example a coil with 10 turns would only require a 3A drive current to create a 30A/m field.

To verify the suitability of a test environment and/or to calibrate the field from an induction coil, 50Hz field survey meters are required. These are not very expensive to buy, and can be hired at more reasonable cost, but if cost is very important they can be easily designed and constructed from published articles, such as [4]. The formula  $V=N.2.\pi.f.\mu_o.H.A$  introduced earlier relates the measured voltage to the field - but in this application  $V$  is the measured voltage from the pick-up coil,  $N$  is the number of turns on the pick-up coil,  $H$  is the rms

value of the magnetic field strength to be determined, and  $A$  is the cross-sectional area of the pick-up coil. This assumes that the pick-up coil is 'air-cored'.

Don't forget that a pick-up coil is most sensitive only to fields along its axis, so to measure an induction coil it is important to align the pick-up coil carefully for maximum output voltage. When characterising a test environment, measurements must be made with the pick-up coil aligned in three orthogonal directions, and the actual field value is obtained by calculating the square root of the sum of the squares of all three measurements. Tri-axial or 'total field' coils can be made, using three orthogonally arranged coils, to save time in aligning the pick-up coil.





The test set-up and other requirements are easy to achieve in most locations. In some situations it may be difficult to employ the ground reference plane as specified by EN/IEC 61000-4-8, but will probably not make a great deal of difference in practice and where a GRP can't be used a note to that effect should be added in the test report.

The simple transformer-based test generator described earlier can be unsuitable where mains waveform quality is too poor; where mains supply levels are too variable; or where automated testing is required. Also, there are a number of reasons why testing may be required with magnetic fields which have a different frequency to the mains supply, e.g..

- 1 The country where the testing is being carried out has a different mains frequency to that of the target market.
- 1 The signal processing techniques used in some products could make them more sensitive to power-frequency magnetic fields at certain very specific frequencies, so these should be tested.
- 1 Uninterruptible power supplies and stand-by generators can have a much wider tolerance band for their output frequencies than is usual for the mains supply. Products exposed to such fields (e.g. all of the medical equipment in a hospital) could use circuits that need to be tested over the whole band.

There is nothing in EN/IEC 61000-4-8 to limit the technology used for the test generator, as long as it meets the necessary specifications. One solution is to use the same variable transformer and step-down transformer circuit but run it from a variable frequency power generator, for example a signal generator followed by a powerful audio power amplifier. Most proprietary audio amplifiers would find the impedance of a single-turn coil too low to drive without a step-down transformer, but induction coils with multiple turns could be designed to match the output current

rating of a typical audio power amplifier, or else a matching transformer could be used to match the output range of the amplifier to the input required by the induction coil.

However, audio amplifiers designed for typical domestic use are often inappropriate and trials of this method have sadly resulted in the destruction of a number of domestic hi-fi power amplifiers. High-power amplifiers intended for scientific and engineering use with a variety of awkward loads, such as the wonderfully robust Amcron PSA2 range, would probably be required and can be hired by the week.

Equipment specifically designed for providing variable-frequency mains power exists, and if it meets EN/IEC 61000-4-8's specification for the mains power source it could be used to drive the variable-transformer and step-down transformer design of the standard test signal generator.

Electronic sources of variable frequency mains, such as power amplifiers and variable mains sources mentioned above might not be able to supply enough power for testing very high levels of continuous or pulsed magnetic fields. In such cases a suitably-rated motor-generator set with a variable-speed gearbox between motor and generator may be a practical solution. Some pulsed applications may require a flywheel on the generator's drive shaft.

**Example of a REO MF6 multiformer - used to provide a sinusoidal output; with an adjustable, regulated voltage, and at various frequencies**

A number of magnetic flux and field strength units are in use, so here are some conversion factors from some of them into A/m (these are only valid in air):

$$1 \text{ A/m} = 4\pi \cdot 10^{-3} \text{ Oersted (Oe)}$$
$$\cdot 12.6 \text{ milliOersted}$$

$$1 \text{ A/m} = 4\pi \cdot 10^{-7} \text{ Tesla(T)}$$
$$\cdot 1.26\mu\text{T}$$

$$1 \text{ A/m} = 4\pi \cdot 10^{-3} \text{ Gauss (G)}$$
$$\cdot 12.6\text{mG}$$





[1] EN 61000-4-8:1993 *"Electromagnetic Compatibility (EMC), Part 4. Testing and measurement techniques. Section 8. Power frequency magnetic field immunity test. Basic EMC publication."*

[2] European Directive 89/336/EEC (as amended) on Electromagnetic Compatibility. The Directive's official EU homepage includes downloadable version of the EMC Directive, a table of all the EN standards listed under the directive, a guidance document on how to apply the Directive, lists of appointed EMC Competent Bodies, and progress on the 2nd Edition EMC directive:  
[http://europa.eu.int/comm/emterpise/electr\\_equipment/emc/index.htm](http://europa.eu.int/comm/emterpise/electr_equipment/emc/index.htm).

[3] EN 55103-2:1996 *"Electromagnetic Compatibility, Product family standard for audio, video audiovisual and entertainment lighting control apparatus for professional use, part 2 - Immunity"*

[4] *"Measuring magnetic fields in your own home"*, Alasdair Phillips, Electronics World + Wireless World, April 1992, pp 281-283

[5] "Comparison of multifrequency magnetic field sources with reference levels", Toni Sjöblom, Marko Suojanen, Tommi Keikko, Jari Kotiniitty and Leena Korpinen, EMC Europe 200 Brugge, 4<sup>th</sup> European Symposium on EMC, September 11-15 2000, Technologische Instituut vzw, ISBN 90-76019-14-2

[6] IEC 61000-2-7:1998 (or later) *"Electromagnetic Compatibility (EMC) Environment Low frequency magnetic fields in various environments"*

[7] R014-001:1999 (or later) *"Guide for the evaluation of electromagnetic fields around power transformers"*

EN and IEC standards may be purchased from British Standards Institution (BSI) at: [orders@bsi-global.com](mailto:orders@bsi-global.com). To enquire about a product of service call BSI Customer Services on +44 (0)20 8996 9001 or email them at [cservices@bsi-global.com](mailto:cservices@bsi-global.com)



**Keith Armstrong from Cherry Clough Consultants**

***This guide is one of a series. Email us if you would like to receive all of our mini guides and to be entered onto our mailing list at [main@reo.co.uk](mailto:main@reo.co.uk)***

Keith Armstrong graduated in electrical engineering with a B.Sc (Hons.) from Imperial College London in 1972, majoring in analogue circuit design and electromagnetic field theory, with Upper Second Class Honours (Cum Laude). Much of his life since then has involved controlling real-life interference problems in high-technology products, systems, and installations, for a variety of companies and organisations in a range of industries.

Keith has been a Chartered Electrical Engineer (UK) since 1978, a Group 1 European Engineer since 1988, and has written and presented a great many papers on EMC. He is a past chairman of the IEE's Professional Group (E2) on Electromagnetic Compatibility, is a member of the IEEE's EMC Society, and chairs the IEE's Working Group on 'EMC and Functional Safety'.

Contact: Keith Armstrong by email at [keith.armstrong@cherryclough.com](mailto:keith.armstrong@cherryclough.com) or visit the Cherry Clough website [www.cherryclough.com](http://www.cherryclough.com)

#### **Acknowledgements**

Some of this material was previously published in 2001 - 2002 in the "EMC Testing" series in the EMC Compliance Journal: <http://www.compliance-club.com>. Many thanks are due to Tim Williams of Elmac Services, <http://www.elmac.co.uk> [timw@elmac.co.uk](mailto:timw@elmac.co.uk), my co-author for that series

