



Good EMC Engineering Practices in the Design and Construction of Fixed Installation



REO UK LTD

Contents

1

1	Introduction and scope of this Guide	2
2	Complying with the EMC Directive	5
3	Background to EMC engineering	26
4	Good EMC engineering practices for general use	40
5	EM mitigation techniques	64
6	Electronic warfare	166
7	Preventing corrosion	167
8	Maintaining EM performance over the operational lifecycle	171
9	References and further reading	173
10	Solutions from REO	180
11	The Author	181
12	REO market sectors	182

This Guide is intended for people who are not EMC experts, although EMC experts might find it (or its references) useful. It avoids the use of mathematics and attempts to communicate good EMC engineering in a way that can easily be understood by all practising architects, electrical consultants, M&E (mechanical and electrical) contractors, electrical engineers, and people appointed as 'Responsible Persons' under the new EMC Directive.

1.1 2004/108/EC mandates new EMC requirements for Fixed Installations

Electromagnetic compatibility (EMC) is the engineering discipline that deals with ensuring that electrical and electronic equipment:

- Does not emit such high levels of electromagnetic (EM) disturbances that they cause too much electromagnetic interference (EMI) to other equipment
- Functions well enough despite the EM disturbances in its environment

The European Union (EU) has a new Directive on EMC, 2004/108/EC [1], which replaces the original 89/336/EEC, and which for the first time includes specific requirements for all 'Fixed Installations'. This is discussed in Section 2 along with the associated 2006 EMC Regulations for the UK.

Financial and safety risks associated with inadequate EMC can be much more important than complying with any

Directive, and are discussed in Section 3.

A number of good EMC engineering practices are required to be able to successfully control the EM characteristics of an installation over its operational lifetime, whether for compliance with the EMC Directive (Section 2) or to reduce financial risks (Section 3). The remainder of this Guide is focussed solely on describing the good EMC engineering practices associated with the mechanical and electrical construction of electrical/electronic systems and installations.

All professional engineers have a duty (professional, ethical, and legal) to apply the latest and best knowledge and practices in their work. Some of the good EMC engineering practices described in this Guide might contradict established or traditional practices – but they represent the state of the art at the time of writing, are all well-proven in practice, and are generally internationally standardised as being good practice.

EMC is a rapidly developing field, because of the rapid pace of progress in electronics, computing, software, power control (e.g. variable speed AC motor drives), radiocommunications and wired/wireless data communications. The accelerating use of these technologies in all applications means that some EMC techniques that might have been perfectly adequate in the 1950s (such as single-point earthing, and bonding cable shields at only one end, see 3.5) are now very bad EMC practice indeed.

1.2 EMC requirements for compliance with the IEE Wiring Reg's (BS7671)

The 17th Edition of the IEE Wiring Regulations (BS 7671) was published in 2008, and like all of the preceding Editions contains no EMC requirements at all. However, at the time of writing, work is well underway at BSI on including EMC requirements in BS7671 to implement IEC 60364-4-44 clause 444 [2] to harmonise with other EU member states. These EMC requirements will be published in the 18th Edition in 2011.

Remember that buildings, plant and sites generally have to comply with BS7671 to meet Health & Safety at Work requirements. So when (not 'if') the 18th Edition of BS7671 comes into force, Health & Safety at Work requirements will mandate the use of good EMC engineering practices in all electrical installations.

1.3 EMC requirements for complying with lightning protection (BS EN 62305)

In August 2008, the UK's venerable lightning protection standard BS 6651 became obsolete, superseded by BS EN 62305 [3] that requires the potential for lightning damage to electronic equipment/systems on a site or in a building to be taken into account in all lightning risk assessments. Such risk assessments were optional under BS6651 Appendix C, and rarely done, but from August 2008 will apply to all new buildings, and almost all commercial, financial, industrial and healthcare premises will have to comply by applying the EMC requirements in BS

EN 62305-4 [3] for the protection of electronic equipment.

We are all used to seeing lightning protection systems on the outside of buildings, but [3] includes requirements for the installations within buildings, including shielding using meshed metal structures and other conductors, radio-frequency bonding and surge protection. It also includes additional requirements for the immunity of items of equipment, to those required by the generic and product standards listed under the EMC Directive, see 5.13.3.

Remember that buildings, plant and sites generally have to comply with lightning protection requirements to meet insurance requirements. So from August 2008, building insurance requirements will mandate the use of good EMC engineering practices within most industrial, military, government, commercial, financial and healthcare buildings.

1.4 How this Guide helps comply with 2004/108/EC, the future BS7671 and BS EN 62305

Although all of these Directives, EMC Regulations and standards mandate good EMC engineering practices, they do not describe how to actually **do** them. For example, in the future IEE Wiring Regulations or BS EN 62305 [3], one can come across requirements such as 'employ a suitable EMC filter' or 'install a surge protector' – but, as Section 5.13 shows, if you don't select the correct type of filter or surge protector, and/or don't install it correctly – it won't work as intended and could even make the situation worse.

The same is true for all other EMC issues – the techniques that are required to make them work in real-life are not described in 2004/108/EC or the UK's associated 2006 EMC Regulations [4]; [3] or the future 18th edition of BS7671. They tell us **what** techniques are required, but they do not tell us **how** to do them.

The situation is made more difficult by the fact that many of the practical EMC engineering techniques that are now required, are not yet commonly used in electrical installations, and there is no tradition of EMC engineering amongst architects, building and site design consultants, electrical installers or M&E Contractors.

This Guide is intended to fill this gap, and provide the necessary understanding of **how** to do good EMC engineering in real life, in practical detail that can be applied immediately.

This Guide does not cover how to do EMC testing, but it includes a wealth of references on doing such testing with various trade-offs between cost, time, and accuracy – and many other issues relating to achieving EMC for Fixed Installations. In any case, there are many EMC test laboratories that one can call upon to perform on-site EMC tests – whereas at the moment there are very few (if any) architects, building and site design consultants, electrical consultants, M&E Contractors, electrical installers, or end-users, who know how to correctly employ good EMC engineering practices. This Guide is intended for them.

1.5 Disclaimer

The information and guidance provided here is general good engineering practice established over many years and backed by numerous standards and other published documents.

However, where significant safety, financial, political or other risks could depend upon anything covered in this Guide – then design, construction and maintenance should be based solely upon a competent and detailed analysis of the application concerned, and should never use these guidelines unquestioningly.

The level of competency and detailed analysis, the amount of work and documentation, and the use of appropriate verification/validation techniques (such as reviews by an independent expert), all depend upon the level of the risk. Appropriate risk assessment techniques are required, and where EMI can be a contributory factor they can become quite complex, see [5] and [6]. A higher risk means more competency, detail, work, documentation, etc. is required in all stages of a project, and guidance on safety risks is available from the UK's Health and Safety executive, for example [7].

2.1 Introduction to the new EMC Directive: 2004/108/EC

This section is based upon the following documents:

- a) The 2nd Edition of the EMC Directive: 2004/108/EC [1] see Figure 1
- b) The EC's official Guide to 2004/108/EC [8]
- c) The UK's EMC Regulations 2006: SI 2006 No. 3418 [4] see Figure 2
- d) The BERR Guide to the UK's 2006 EMC Regulations [9]
- e) The EC's 'Blue Guide' [10]

Each EU Member State's national law implementing the EMC Directive is

supposed to have the same effect, but the UK's EMC Regulations 2006 go into a lot more detail than 2004/108/EC and make it easier to understand what is actually required.

There was always confusion about how the 1st Edition EMC Directive (89/336/EEC) applied to custom-made (bespoke) equipment, and to systems and installations. It just wasn't written well enough – it was supposed to apply to all electrical/electronic equipment, but its writers only provided compliance details for volume-manufactured equipment sold in shops and through distribution.

Figure 1 The 2nd Edition of the EMC Directive: 2004/108/EC

L 390/24	EN	Official Journal of the European Union	31.12.2004
DIRECTIVE 2004/108/EC OF THE EUROPEAN PARLIAMENT AND OF THE COUNCIL of 15 December 2004 on the approximation of the laws of the Member States relating to electromagnetic compatibility and repealing Directive 89/336/EEC (Text with EEA relevance)			
THE EUROPEAN PARLIAMENT AND THE COUNCIL OF THE EUROPEAN UNION,	(5)	The electromagnetic compatibility of equipment should be regulated with a view to ensuring the functioning of the internal market, that is to say, of an area without internal frontiers in which the free movement of goods, persons, services and capital is assured.	
Having regard to the Treaty establishing the European Community, and in particular Article 95 thereof,			
Having regard to the proposal from the Commission,	(6)	The equipment covered by this Directive should include both apparatus and fixed installations. However, separate provision should be made for each. This is so because, whereas apparatus as such may move freely within the Community, fixed installations on the other hand are installed for permanent use at a predefined location, as assemblies of various types of apparatus and, where appropriate, other devices. The composition and function of such installations correspond in most cases to the particular needs of their operators.	
Having regard to the opinion of the European Economic and Social Committee (7),			
Acting in accordance with the procedure referred to in Article 251 of the Treaty (8),			

Figure 2 The UK's EMC Regulations 2006: SI 2006 No. 3418

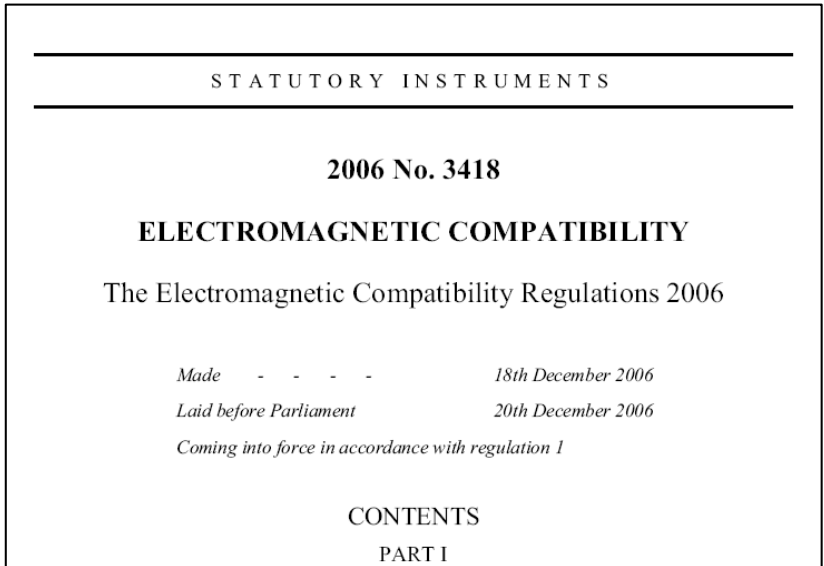

Dispelling this confusion was a main aim of the EC's 1997 Guidelines on the EMC Directive, but this was only an official guide and did not change the EMC Directive, or the national implementing legislation in the member states.

Since the 1997 Guidelines had no legal force, many organisations (including some government organisations) and companies working in the area of custom equipment, systems and installations chose to ignore them and instead continue with their idiosyncratic interpretations on how they thought the original EMC Directive, 89/336/EEC, should apply to them.

Strangely, these interpretations usually resulted in them having to do very little

EMC work. And so over the 10 years that 89/336/EEC was in force some very odd views (e.g. that the EMC Directive did not apply at all to installations) and some very incorrect EMC practices (such as the so-called 'CE + CE = CE approach to compliance', see 2.3.4) arose.

The singular absence of enforcement activities targeted at custom equipment, systems or installations did nothing to discourage such views and practices, which became so commonplace and so entrenched that most people working in these areas seemed to assume they were correct interpretations of the Directive.

Setting out a coherent regime for dealing with custom equipment, systems and

what it calls ‘fixed installations’ was one of the main issues during the creation of 2004/108/EC. Its resulting requirements owe quite a lot to the EC’s 1997 Guidelines.

2.2 2004/108/EC and Safety

First of all it is important to clear up the relationship between the EMC Directive and safety. Two kinds of safety need to be considered:

- Functional Safety (errors in operation, misoperation, malfunction or failure to function, that increases safety risks)
- Hazards to human health

2.2.1 EMC for Functional Safety

Neither 2004/108/EC [1] nor the UK’s 2006 EMC Reg’s [4] cover functional safety issues. Where errors or malfunctions in electrical, electromechanical, electronic or programmable electronic devices, equipment, systems or installations could increase human safety risks, the work required to control EMI to achieve acceptable levels of risk could be very much greater than is required simply for compliance with 2004/108/EC.

These ‘EMC for Functional Safety’ issues need to be fully addressed when complying with:

- The Product Liability Directive [11] (which is mandatory for all goods supplied in the EU)
- IEC/EN 61508 [12]
- IEC/EN 61551 [13]
- IEC/EN 62061 [14]
- The Machinery Directive [15]

- The Low Voltage Equipment Directive (LVD) [16]
- The Medical Device Directive: 93/42/EEC
- The Active Implantable Medical Devices Directive: 90/385/EEC
- The In-Vitro Diagnostics Directive: 98/79/EEC
- The General Product Safety Directive: 2001/95/EC
- Any other EU safety directives, such as: Personal Protective Equipment, Potentially Explosive Atmospheres, etc. where electrical, electromechanical, electronic or programmable electronic technologies are involved.

Unfortunately, as yet there are *no* unpublished EMC or safety standards that effectively control functional safety risks caused by EMI, for any types of equipment or systems (including medical), published by any standards organisations worldwide. This includes all safety standards that include EMC requirements.

At the time of writing (March 2008) the only standardisation work that is at all effective in the area of EMC for Functional Safety is the 2nd Edition of IEC/TS 61000-1-2 [17]. This is unlikely to be adopted as a full IEC standard for at least 5 years (maybe 10) – but this does not stop it from being used. The author hopes to get its principles adopted in the 4th Edition of IEC 60601-1-2 (EMC for medical equipment) but it is too soon to say whether this will happen.

However, the Institution of Engineering Technology (IET) has a Guide on EMC and Functional Safety [5], which

describes the practical steps that should be taken.

This guide is written in a way that makes it easy for any industry to understand and use right away.

However, at least we can say that fully applying good EMC engineering practices as required by 2004/108/EC for fixed installations and described in this Guide, should in general help to reduce the possibility that EMI will lead to safety incidents.

2.2.2 EMC and human health risks

Neither 2004/108/EC [1] nor the UK's 2006 EMC Reg's [4] cover health hazards caused by human exposure to electromagnetic fields (EMFs). In the EU this is controlled by EC Recommendation 1999/519/EC, which gets its legal force via the Low Voltage Directive [16] and via the Radio & Telecommunications Terminal Equipment Directive (1999/5/EC).

However, at least we can say that fully applying good EMC engineering practices as required by 2004/108/EC for fixed installations and described in this Guide, should in general help to reduce the possibility that EMFs will cause hazards to human health.

2.3 Applying 2004/108/EC

2.3.1 Applying the Directive to fixed installations

2004/108/EC applies to equipment that is placed on the market or put (taken) into service. Its definition of 'equipment' includes both 'apparatus' and 'fixed installations', with special legal meanings for the common words:

apparatus, and *fixed installation*. The terms 'placed on the market' and 'put into service' are not defined in 2004/108/EC, so the EC 'Blue Guide' [10] definitions apply.

2004/108/EC treats fixed installations very differently from apparatus, as shown by Figure 3. Apparatus is not within the scope of this Guide so its requirements are not described here. Fixed installations are discussed in 2.3.3 – 2.3.13, and '[apparatus intended for use in a specified fixed installation and not otherwise commercially available to an end user as a single commercial item](#)' is discussed in 2.5.

All fixed installations in the EU must comply fully with 2004/108/EC from 20 July 2007.

Unfortunately, 2004/108/EC does not say what this means for the very large numbers of fixed installations in the EU that were already in existence before the 20th July 2007, and its EC Guide [8] is no help either. However, the UK's 2006 EMC Regulations [4] says that pre-existing fixed installations must only comply if they are modified on/after 20th July 2007. The UK's Guide [9] goes even further and says that compliance is only required for the areas of the fixed installation where the EMC characteristics were affected by the modifications.

The UK Regulations and its Guide place very reasonable and practical interpretations on what it means for a pre-existing fixed installation to comply with 2004/108/EC. But it is important to note that the actual legal text of 2004/108/EC could *possibly* be interpreted as meaning that instead every fixed installation in the EU must fully comply from 20th July 2007

Figure 3 Applying 2004/108

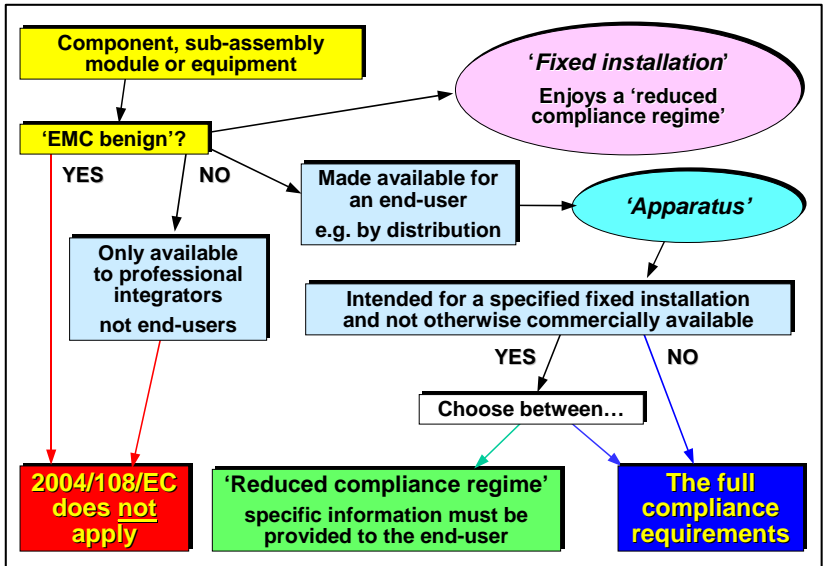

– which is of course impossible. Similarly, the actual legal text in the UK's 2006 EMC Regulations could *possibly* be interpreted as meaning an entire installation must be made to comply if any part of it is modified – which, if not impossible, would of course be totally impractical.

2.3.2 Inherently benign equipment

'Inherently benign equipment' is equipment that is incapable of emitting any significant EM disturbances, and also incapable of being interfered with by the normal EM disturbances in its environment. As such, it is excluded from the scope of 2004/108/EC, whether it is an apparatus or a fixed installation.

The EC Guide [8] contains a list of what is currently *considered* to be inherently benign:

- Cables and cabling, cables accessories, considered separately;
- Equipment containing only resistive loads without any automatic switching device; e.g. simple domestic heaters with no controls, thermostat, or fan;
- Batteries and accumulators (without active electronic circuits)
- Headphones, loudspeakers without amplification
- Pocket lamps without active electronic circuits
- Protection equipment which only produces transitory disturbances of short duration during the clearing of a short-circuit fault or an abnormal situation in a circuit and which do not include active electronic components, such as fuses and

circuit breakers without active electronic parts or active components

- High voltage types of equipment in which possible sources of disturbances are due only to localised insulation stresses which may be the result of the ageing process and are under the control of other technical measures included in non-EMC product standards, and which do not include active electronic components.
- Capacitors (e.g. power factor correction capacitors)
- Induction motors
- Quartz watches (without additional functions, e.g. radio receivers)
- Filament lamps (bulbs)
- Home and building switches which do not contain any active electronic components
- Passive antennas used for TV and radio broadcast reception
- Plugs, sockets, terminal blocks, etc.

Note that passive (e.g. moving-coil) loudspeakers and headphones can be interfered with by audio-frequency magnetic fields, although the levels required are not often met in normal applications. Quartz watches have been known to suffer from interference. Home and building switches always emit broadband EM noise and conducted transients when they break a current, which some switches might do quite often in some applications, and the levels can exceed 1kV. Approximately 1% of coiled-coil mains-powered filament lamps are significant VHF transmitters.

The EC's Guide does not say so, but it is reasonable to assume that any equipment that contains any semiconductors (rectifiers, transistors, ICs, MOVs, transorbs, etc.) or thermionic valves cannot be considered EMC benign.

2.3.3 Definition of a 'fixed installation'

Fixed installations are defined as:

"A particular combination of several types of apparatus and, where applicable, other devices, which are assembled, installed and intended to be used permanently at a predefined location."

This definition covers all installations from the smallest residential electrical installation, through to national electrical and telephone networks, including all commercial and industrial installations. The EC Guide's examples of fixed installations include...

- Industrial, and power generating plants
- Electrical power distribution networks
- Telecommunication, and cable TV networks
- Computer networks
- Airport luggage handling, and runway lightning installations
- Automatic warehouses
- Skating hall ice rink machinery installations
- Storm surge barrier installations (with the control room etc)
- Wind turbine stations
- Car assembly plants

- Water pumping stations, and water treatment plants,
- Railway infrastructures
- Air conditioning installations

Notice that a fixed installation need not be a whole site; it could be a part of a site, such as the electrical wiring, computer network, HVAC installation, etc. So a given building or site could have several fixed installations within it, each with their own Responsible Person (see later).

A fixed installation is intended for permanent use at a predefined location, which means it was constructed with the intention of being permanently located at that particular location. According to the UK's guide, if its constituent parts are expected to be moved during their expected lifetime, and taken into service at another location, then it is not after all a fixed installation, and must be treated as an apparatus instead.

End-users create all sorts of fixed installations, for example domestic multi-media system/installations in their own homes. But if they are not doing it professionally, and if they only use apparatus that is compliant with the EMC Directive and intended by their manufacturers for the use they put it to – then no further EMC actions are required for compliance with the Directive.

Fixed installations are made of 'apparatus' or 'other devices'. There are three kinds of apparatus covered by the EMC Directive:

- Benign apparatus that inherently complies with the Essential Requirements.
- Apparatus placed on the market for an end user. These are items that anyone can buy, from a shop, distributor, catalogue or website. They are generally manufactured in quantities of more than one, and their requirements for EMC compliance and CE-marking under 2004/108/EC are not discussed in this Guide.
- Apparatus intended for incorporation into a specified fixed installation and not otherwise commercially available to an end-user as a single functional unit, see 2.5.

According to [8], the 'other devices' that can be used to create a fixed installation means items that are not covered by the EMC Directive.

The term '*Large Machine*' appears in [1]. If a large machine meets the definition given for a fixed installation, then it is treated as such. In all other cases, large machines are treated either as...

- Apparatus...
- Or 'apparatus intended for a specified fixed installation and not otherwise commercially available' (see 2.5)

'*Mobile Installations*' are defined as: "...a combination of apparatus and, where applicable, other devices, intended to be moved and operated in a range of locations.", and [8] uses the example of an outside broadcast vehicle. Mobile installations are treated as apparatus that is placed on the market for an end-user, because – just like products sold in shops – they can be used anywhere in the EU, and the manufacturer has no control over their EM environment.

The term '*Moveable Installation*' does not appear in [1], but is a term that has been proposed for something that is constructed anew on each site, such as

a fairground, open-air touring pop concert, etc. [8] says:

“Installations which are regularly dismantled and rebuilt at different locations are not considered as mobile installations. They may thus be identified as apparatus or as fixed installations according to the particular cases.”

The word ‘System’ is commonly used to describe a variety of possible constructions, but does not appear anywhere in [1]. [8] discusses a limited range of systems, but is not comprehensive. Where a system is created and supplied to an end-user by a manufacturer – if it fits the definition of ‘apparatus’ it is treated the same way as an apparatus. But a custom-engineered (bespoke) system is considered to be: ‘apparatus intended for a specified fixed installation and not otherwise commercially available’ (see 2.5).

Where end-users create their own systems, they are either treated as fixed installations in their own right, or as component parts of fixed installations.

2.3.4 CE + CE does not equal CE

The ‘CE + CE = CE approach’ is the name given to the assumption that if someone buys CE-marked items of equipment ‘in good faith’ and assembles them following their suppliers’ instructions, then there is no more EMC work required to make the resulting equipment (apparatus, system or fixed installation) comply with the EMC (or any other CE-marking) Directive.

This approach is acceptable for end-users who are not doing it professionally (see 2.3.3), but not otherwise. There has never been any legal or technical justification for the use of this approach

(see [18]) but unfortunately this has not stopped it from being widely used at all levels of all industries.

[8] includes the following statement:

“It should be noted that combining two or more CE-marked finished appliances does not automatically produce a “compliant” system e.g.: a combination of CE-marked Programmable Logic Controllers and motor drives may fail to meet the protection requirements.”

This should make it much harder for anyone using the CE +CE = CE approach to successfully argue that their product, system or fixed installation complies with the EMC Directive.

2.3.5 Requirements for fixed installations

Unlike apparatus placed on the market for an end-user, fixed installations are not required to have...

- An electromagnetic compatibility assessment
- A Conformity Assessment
- An EC Declaration of Conformity (DoC)
- The CE-marking affixed

But, as shown in Figure 3, 2004/108/EC does apply a “reduced compliance regime” to fixed installations – they must comply with the Directive’s ‘Essential Requirements’, which has two parts:

- 1) The Protection Requirements
- 2) The Specific Requirements for Fixed Installations

The **Protection Requirements** state:

“Equipment shall be so designed and manufactured, having regard to the state of the art, as to ensure that:

- a) the electromagnetic disturbance generated does not exceed the level above which radio and telecommunication equipment or other equipment cannot operate as intended;
- b) it has a level of immunity to the electromagnetic disturbance to be expected in its intended use which allows it to operate without unacceptable degradation of its intended use."

The Protection Requirements are just a statement of what EMC is all about, and it is hard to imagine that any manufacturer or installation owner would be happy if these requirements were not met in practice.

It is important to understand that a fixed installation is something that the *end-user creates for his own use*. A manufacturer cannot supply a fixed installation to an end-user [19]. Anything that a manufacturer supplies to an end-user must conform with the EMC Directive either by being a CE-marked apparatus, or by being 'apparatus intended for a specified fixed installation and not otherwise commercially available' (e.g. custom-designed equipment).

The EMC conformity and CE-marking of apparatus is not covered in this Guide, but the conformity of 'apparatus intended for a specified fixed installation and not otherwise commercially available' is covered in 2.5. A contractor who is providing assembly/installation services to an end-user according to the end-user's design, is not a manufacturer, and so the EMC Directive does not apply to him, see 2.4.

The Specific Requirements for Fixed Installations have three parts:

- A) The application of "good engineering practices"
- B) Installation "respecting the information on the intended use of its components, with a view to meeting the essential requirements"
- C) Documentation of the good engineering practices that have been employed, kept ready for inspection, by a named "Responsible Person", for as long as that installation is in operation.

These three issues are discussed in following subsections.

2.3.6 The application of Good Engineering Practices

The phrase 'good engineering practices' actually means 'good EMC engineering practices having regard to the state of the art'. For example, although BS7671 (the IEE Wiring Regulations) are good engineering practices and reflect the state of the art in electrical wiring for inherent safety purposes, they do not (at the time of writing) cover EMC practices and so they are not appropriate for complying with the EMC Directive.

The EC's Guide has the following to say about good EMC engineering practices: "Good engineering practice comprises of suitable technical behaviour taking into account recognised standards and codes of practice applicable to the particular fixed installation. The "good engineering practices" referred to in Annex 1, 2 mean practices which are good for EMC purposes, at the specific site in question. General information on good engineering practice within the

context of installations is available in several EMC handbooks, courses and technical reports. For example some technical reports published by standardisation bodies deal with installation and mitigation guidelines for EMC. Good engineering practices, particularly in the field of EMC, are in constant evolution. Whilst there is a need to have regard for the 'state of the art' practices it does not necessarily follow that they are relevant for all installations. Standards for installations cannot cover all specific local conditions: therefore it is necessary to be aware of some guiding principles when aiming to demonstrate installation according to good engineering practices:

- Emissions: take appropriate actions to mitigate the source of disturbances by EMC design, e.g. by the addition of filters or of absorption devices etc.
- Coupling and radiation: take appropriate actions in respect of distances, equipotential earthing, selection of cables, shielding etc.
- Immunity: take appropriate actions to ensure that sensitive equipment is protected against the various types of disturbances that might be expected.

When applying the protection requirements to a defined fixed installation, it is essential to define the borderlines/geographical limits of this fixed installation in order to distinguish it clearly from the external environment.

It is fundamental to identify:

- The ports/interfaces where conducted (high or low frequency) disturbances may cross the borderline from or towards the fixed

installation (power supply port, control and telecommunication ports etc.)

- The coupling mechanism with the external environment
- The radiation towards or from the external environment

It should be noted that it is not the purpose of the EMC Directive to ensure electromagnetic compatibility between specific equipment inside the borders of the defined fixed installation."

The final sentence in the quotation above means that the EMC Directive is only concerned with 'inter-system' interference (between a fixed installation and other equipment) – and is not concerned with items of equipment within an installation interfering with each other, known as 'intra-system' interference. Intra-system interference is not uncommon, can cause significant lost production, and may be more important financially to the owner of the installation than inter-system interference (see 3.1).

So this Guide covers good EMC practices for both inter- and intra-system interference, to help everyone maximise cost-effectiveness whilst reducing financial risks and complying with legal requirements.

This requirement to employ 'good EMC engineering practices having regard to the state of the art', is a big problem for end-users, architects, electrical consultants, system integrators, panel builders, custom engineers, M&E (mechanical and electrical) contractors, and electrical engineers, etc., since most of them seem to believe that all that is required for good EMC engineering is to use single-point earthing (grounding),

terminate cable shields at one end only, and that any length of wire may be used to terminate a cable shield or 'ground' a filter – as long as it has green/yellow insulation.

These might possibly have been acceptable EMC practices in the 1950s, when FM Radio and Television at VHF were new and considered to be the pinnacle of high technology, and digital circuits and software were not even on the horizon. But they are generally bad EMC engineering practices these days, so they fail the 'having regard to the state of the art' requirement in the new EMC Directive.

But the date, 20th July 2007, on which good EMC engineering practice was made mandatory for all fixed installations in the EU has passed, and very few (if any) of the people involved with designing, creating and maintaining fixed installations seem to have any clue about how to do it properly.

We just have to hope that the enforcement activities are as insignificant as they were under the old EMC Directive. In fact there is every likelihood that they *will* be stepped up during the next few years, due to a proposed EU Directive that would force Member States to do more enforcement [20].

2.3.7 Following suppliers' EMC instructions

2004/108/EC describes this requirement as the practice of constructing a fixed installation:

“...respecting the information on the intended use of its components, with a view to meeting the Essential Requirements”.

This means that EMC installation and use instructions should be obtained from each equipment supplier, and then applied as appropriate.

The word 'respecting' implies that it is not mandatory to mindlessly follow a supplier's EMC instructions – which is a good thing because sometimes they can be unsuitable for a particular application that the supplier had not envisaged. However, the supplier's instructions must be 'respected', so if they are not followed exactly their EMC effect should be achieved by whatever means are most appropriate to the installation, using good EMC engineering practices 'having regard to the state of the art'.

2.3.8 The Responsible Person

A Responsible Person must be identified by name for each fixed installation. He or she is responsible for ensuring that the fixed installation complies with the EMC Directive (which means complying with the Protection Requirements plus the three special requirements for fixed installations) – and also must keep documentation showing how good EMC engineering practices have been employed since the 20th July 2007 (see 2.3.10). This compliance documentation must be kept ready for inspection by the national EMC enforcing authorities for as long as the fixed installation is in operation.

The Directive allows each EU member state to decide on its own rules for identifying Responsible Persons.

For the UK, SI 2006 No.3418 [4] defines a Responsible Person (for a fixed installation) as...

“...the person who, by virtue of their control of the fixed installation is able to

determine that the configuration of the installation is such that when used it complies with the essential requirements.”

And the UK's Guide [9] says:

“It will be necessary for operators of fixed installations to identify the responsible person before the installation is taken into service”

Notice especially that a Responsible Person must have authority (control) over the design and construction of the fixed installation they are responsible for. The UK's Guide also says that a Responsible Person does not have to be an EMC expert, and can seek appropriate advice in fulfilling their obligations. *But they cannot delegate their responsibility.*

As 2.3.3 shows, there could be several fixed installations on a given site (e.g. computer network, HVAC system, etc.), each with their own Responsible Person. In such situations it seems reasonable to expect the Responsible Persons to coordinate their activities so that the entire site complies with the EMC Directive's Protection Requirements by not causing unacceptable interference to other equipment. It also seems reasonable for them to work together to ensure that the different fixed installations on the site do not cause unacceptable interference with each other.

It seems likely that many responsible persons will try to treat 2004/108/EC in the same way they deal with other technical issues (such as the IEE Wiring Regulations, BS7671) by not bothering to learn much about it – simply expecting their suppliers, architects, electrical consultants and M&E Contractors to do

it all for them, and provide them, at the end of the project, with all of the compliance documentation that they are supposed to keep ready for inspection by the authorities.

But few suppliers, and even fewer architects, electrical consultants or M&E contractors have adequate EMC skills (yet), and ensuring EMC compliance for a fixed installation can be a complex issue, requiring a level of overall knowledge and control of the installation that most contractors do not have – or are not permitted to have (especially a problem when a contractor is required just to work on a modification).

2.3.9 EMC skill requirements

Unfortunately for the level of EMC skills required to be applied by (or on behalf of) Responsible Persons, the compliance of a fixed installation can easily become complex, for example...

- Suppliers' instructions can be contradictory, often requiring significant EMC expertise to resolve the conflict using good EMC engineering practices
- The emissions from large numbers of individually EMC compliant items of equipment can build up to cause serious interference problems, especially: variable-speed motor drives; variable-power heaters; electronically-controlled luminaires; low-energy lightning; wireless communication systems; etc.

For example, Figure 4 shows an example of the control cubicle for a modern sausage-manufacturing machine. Machines incorporating variable-speed AC or DC motor drives almost always require very careful

design, construction, installation and maintenance in order to be EMC

compliant.

Figure 4 Example of a Fixed Installation that has very complex EMC issues

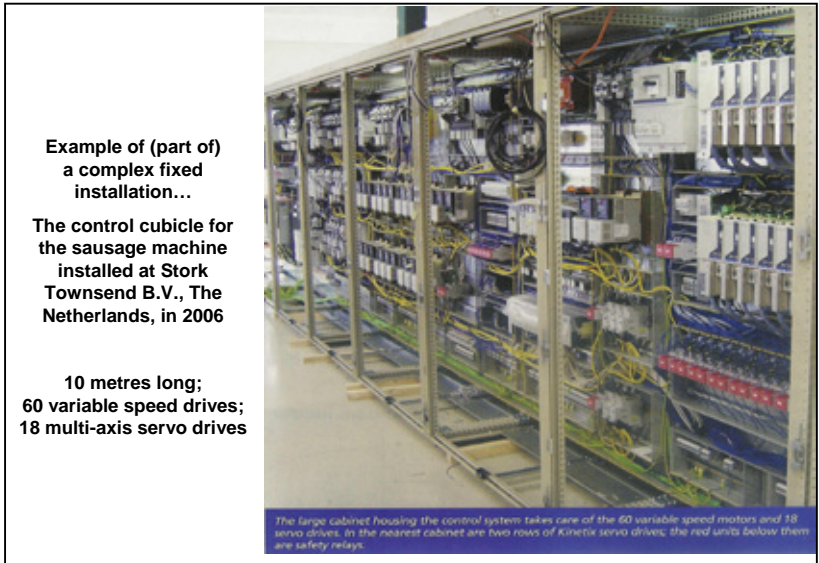

To complicate matters still further, the harmonised EMC standards that are used to CE mark apparatus make certain assumptions that are often not true in real-life installations, for example they assume that:

- Personal hand-held cellphones and walkie-talkies are not used nearby (but they always are, in real life)
- Group 2 ISM equipment is not used nearby (but it can be, in real life)
- Powerful vehicle-mobile transmitters (e.g. police, ambulance, fire, taxi, etc.) are not used nearby (but they can cause problems, in real life, if a vehicle can get within 10 metres, and

typical walls present little barrier to their signals).

- All vehicle-mobile radio transmitters operate within legal power ratings. However, it is known that some long-distance commercial vehicles (trucks, juggernauts, etc.) are fitted with illegal CB radio transmitters rated at 1kW or more, allowing them to communicate with their bases across whole continents. The very high levels of emissions from these have been implicated in bus crashes in Japan (see No. 331 in [21]), and several other incidents, and they could be a concern if an installation

is situated close to a route of depot used by long-distance hauliers.

- Overvoltage surges on the mains supply are no higher than $\pm 2\text{kV}$ (but $\pm 6\text{kV}$ or more is widely known to occur on single-phase installations in real life, see [22], and $\pm 12\text{kV}$ or more can occur on three-phase systems that have no single phase mains sockets or equipment connected.)
- Electrostatic discharge (ESD) occurs up to 8kV (but $>15\text{kV}$ can occur during periods of low humidity (see IEC 61000-4-2) and 25kV or more has been reported in a number of facilities including hospitals (see No. 418 in [21]).)
- That only one EM phenomenon occurs at a time (not true in real life). [23] shows that apparatus that passes each of its 'CE' immunity tests individually, can fail very easily when two EM disturbances at the same or lower levels occur at the same time.
- Some EM phenomena can be ignored (e.g. continuous EM disturbances between 50Hz and 150kHz , and above 1GHz) – which might not be the case for certain installations
- EMC performance does not vary with ambient temperature (but it does, see [24])
- EMC performance does not vary with ageing and wear-and-tear caused by the physical environment (but it always degrades over time, see [25])
- There is no electric arc welding taking place nearby (but it can be, during modification or maintenance works)

Other concerns about the suitability of the 'CE-marking' EMC test standards for real-life applications exist, and some of them are expressed in [26].

For example, and considering Figure 4, the EMC standard for motor drives, IEC/EN 61800-3, that is listed as providing a 'presumption of conformity' under the EMC Directive, can be less than helpful to end-users trying to make their Fixed Installations EMC Compliant. Soon after its initial publication, the European Association of Competent Bodies (renamed the European Association of Notified Bodies under 2004/108/EC) requested that the European Commission (EC) withdraw this standard from being listed under the EMC Directive.

This (and similar) requests were not successful, but eventually the EC did appoint an EMC expert whose job, amongst others, was to approve or reject new EN standards for listing under the EMC Directive. Different experts have different views, for example one EC EMC Consultant thought that the EN 550121 series of EMC standards for railway equipment and installations did not provide sufficient protection for listing under the EMC Directive (a view shared by many other experts, including this author), but when he was replaced by a different expert the 550121 series was suddenly approved and listed under the EMC Directive without any modifications.

Equipment that fully meets harmonised EMC standards can still cause or suffer significant EM interference. Excessive levels of EM emissions are especially likely from electric traction (trams, trains, cars), and Group 2 ISM equipment under EN 55011 (CISPR 11) [27], e.g. diathermic heating devices, plastic bag

sealers, glue dryers, microwave heaters/cookers/dryers, induction heaters, electromagnetic stirrers, electric welders, etc.

Group 2 [27] allows very high levels of emissions at the 'ISM' frequencies – a number of narrow frequency bands that are not used for broadcasting or licensed radiocommunications, set aside by international agreement for use by industry, science and medicine (hence: 'ISM') so that they can use high-power radio-frequency (RF) equipment without interfering with radio and TV reception over large areas. But the emissions from [27] Group 2 that is legitimately 'CE-marked' under the EMC Directive could be so high in its vicinity as to cause hazards to human health (see 2.2.2) and to interfere with almost any electronic equipment.

It is also notable that some of the ISM bands are now being used for unlicensed communications, in particular the 2.4GHz band is being extensively used by Wi-Fi, Bluetooth, ZigBee, and a number of other low-cost wireless data and voice communication systems. At the time of writing, many industries and healthcare premises are enthusiastically embracing these wireless systems, using them in place of wired datacommunications because they cost less.

Many people have experienced problems with their domestic Wi-Fi when their microwave cooker (a Group 2 ISM apparatus) operates. But more powerful Group 2 ISM equipment is capable of wiping out these new ISM-band wireless systems over large areas – and the fact that this is perfectly legal is no comfort to those whose wireless LANS and

Bluetooth or ZigBee systems no longer function.

All of the above (and more) are issues that EMC consultants worldwide are often employed in solving – actual problems in real-life systems and installations. They exemplify some of the reasons why simply relying on suppliers providing products that comply with standards listed under the EMC Directive, and following their EMC instructions, is not necessarily sufficient to ensure compliance. The situation will only get worse as increasing amounts of more sophisticated electronics and power-control are used in installations, and as the EM environment continues to worsen and power quality continues to degrade.

2.3.10 Documenting EMC compliance

There are no EMC standards for fixed installations listed under 2004/108/EC, for emissions or immunity. However, the [27] test method is specified for 'in-situ' measurements of the emissions from items of large industrial 'ISM' equipment after installation, and is sometimes used for assessing the emissions from an entire installation at the boundary of its site. DD CLC/TS 50217 [28] is a draft CENELEC Technical Specification that can also be helpful for measurements of an installation's emissions. It is *possible* (though not considered to be very likely) that some appropriate standards for measuring the emissions and immunity of a fixed installation could be created in the future and listed under 2004/108/EC.

Where a simple fixed installation consists solely of apparatus (placed on the EU market for an end-user, conforming to the EMC Directive, carrying the CE-marking), the

Responsible Person *might* be able to satisfy the documentation requirements simply by retaining the EMC instructions for installation, use and maintenance, provided by the suppliers, and keeping records that show these instructions were followed using good EMC engineering practices.

But the provision of such user EMC instructions is a new requirement for apparatus in 2004/108/EC, and until 20th July 2009 types of equipment that were already on sale in the EU can continue to be legally sold as compliant with the 1st Edition EMC Directive (89/336/EEC as modified) *without* such instructions. So this Guide recommends that potential suppliers are asked about the availability of comprehensive EMC installation and use instructions as part of the process of deciding which apparatus to purchase.

As discussed in 2.3.9, EMC issues can become very complicated. The good practices described in this Guide can deal with all of those issues, and the compliance documentation should show how the issues were identified during the design process and realised in practice.

There are no mandatory requirements for the types of documentation that the Responsible Person must keep but (except for the simplest systems) it should show how sufficient confidence in complying with the Protection Requirements, was achieved, for example by...

- Knowledge of the EM environment (assessments, calculations, site measurements, etc.)
- Knowledge of the EM characteristics of the equipment incorporated into the installation

- Use of EM mitigation measures (shielding, filtering, etc.)
- Calculations, site measurements, etc.,

and the use of good EMC engineering practices must be documented, for example by...

- Retaining all of the EMC assembly/installation/operation instructions received from suppliers
- Reference to other specifications describing appropriate good EMC engineering practices
- Records of inspections, photographs, etc., showing that the specified practices were followed

The form in which compliance documentation should be kept is not specified, but this Guide assumes that graphics and text files on a computer system would be appropriate, as long as they can quickly be displayed or printed out for the benefit of an enforcement officer, and are reliably backed-up off-site.

Since the compliance documentation has to be kept available for the operational life of the installation, which could be decades, the ability to read the computer records many years after their creation is important. So either old systems that can read them should be maintained, or the data converted (without errors) to new versions or formats of computer software as necessary to keep them readable on current systems.

2.3.11 Enforcement possibilities

If the EMC of the fixed installation is suspect, or if complaints of interference

are received, the national EMC authorities may request evidence of compliance (probably assessing the Responsible Person's documentation), or initiate an investigation (probably actual measurements of the site's emissions or immunity).

Where non-compliance is established, the authorities may impose measures to bring the fixed installation into compliance with the essential requirements. This could simply mean switching the offending installation off, until such time as it has been modified and can be shown to be compliant – an enforcement action that has already been taken a number of times in the past, in the UK at least, when installations caused troublesome interference problems outside their site boundaries.

2.3.12 The continuing compliance of fixed installations

Some installations are located remotely, which helps them avoid suffering/creating interference. But what if – in the future – radio, telecom or other equipment is used nearby? For example, if a housing estate, commercial park, entertainment venue, sporting arena, industrial development or public road is built nearby?

Modifying a fixed installation to reduce its emissions can be very costly indeed, with a long downtime and huge loss of production. So should installations comply with all such possible future requirements when they are first constructed, so as not to have to be modified later on in case of such developments? Or is it acceptable to rely on remote locations to prevent interference from 'noisy' installations,

even if they do not own sufficient area of land all around them to ensure that this happy situation is maintained for the operational life?

The EM environment will inevitably change over time. It changed dramatically during the 1990s with the rollout of GSM cellphone systems, and in the UK it changed during 2005-7 due to the rollout of the TETRA communications system. Both of these roll-outs caused significant interference problems to a variety of existing electronic equipment, now mostly solved (but paid for by the people who *suffered* the interference). In the near future we will see the large-scale rollout of Wi-Fi at 2.4 and 5-6GHz, with some cities going for metropolitan coverage instead of a few 'hot spots' in cafés and the like.

Other roll-outs in the pipeline include WiMAX, 4G cellphone systems, and the large-scale use of switch-mode power conversion in industry and in all motorised household appliances to save energy (and hopefully the planet) – which will considerably increase the levels of electromagnetic disturbances at RF on the public 230/400V mains supplies.

Further into the future, changes to the way that the radio spectrum is licensed are looking likely, allowing the use of software-defined and cognitive radio systems, so that radio 'channels' will no longer use fixed frequencies. This will allow a much greater volume of radio and TV transmissions to be fitted into the RF spectrum – with all sorts of hard-to-predict implications for interference.

As equipment wears and ages its EM performance (e.g. shielding, filtering, surge suppression) generally degrades, but fixed installations must continue to

comply with 2004/108/EC throughout their life.

2.3.13 Purchasing a building, plant or site containing Fixed Installation(s)

When a site, plant or building is sold to a different end-user, the new owner's Responsible Persons become responsible for all of the good EMC engineering practices of their fixed installations and all of their EMC compliance documentation since the 20th July 2007 [19].

For any given Fixed Installation there is a good chance that the EMC compliance documentation will not be complete, or that it will not have been done with the attention to detail required by its new Responsible Person.

So, to help avoid taking on unknown financial risks when purchasing a building, plant or site, it is strongly recommended that the EMC compliance documentation is checked thoroughly *prior to purchase*. Where the documentation is poor, the prospective purchaser might want to offer a lower price, to allow for the financial risk.

2.4 Architects, consultants and M&E Contractors

This Guide recommends that architects, electrical consultants and M&E contractors discuss the following, with the Responsible Person for the fixed installation they are working on, *before quoting for the work*:

- What EMC activities they are required to perform
- What EMC information on the existing installation they will be provided with, what must they find

out for themselves, and what they are not permitted to know

- What EMC documents they are required to provide at the end of the contract
- How much they will be paid for the extra EMC work covered by the above three bullets

There is a lot of competition in consultancy and contracting, which tends to drive down prices; so many consultants and contractors might be unwilling to follow the above recommendation for fear of being undercut by someone who ignores EMC issues.

So this Guide recommends that quotes contain two prices: one being the price following the usual pricing rules already established that ignore good EMC engineering practices and compliance with 2004/108/EC, and the other with the good practices and their documentation included. Then the customer can see that the quote is competitive in the 'usual' way, and also see what he has to pay if he wants the added EMC services.

The problem is that some Responsible Persons will assume that 2004/108/EC applies to their consultants and/or M&E contractors (it doesn't) and so will assume that any quoted price includes all the necessary good EMC Engineering practices and provision of EMC documentation. This will mean that these service providers could face great difficulties in getting paid; when it turns out they have no EMC documentation to provide at the end.

So it is best to get all this sort of nonsense out of the way before accepting a contract. If the customer says he wants things doing the 'usual'

way – ignoring good EMC engineering practices – then the ‘usual’ pricing rules apply. But if the customer wants good EMC engineering applying and additional documentation providing, he must be prepared to pay for the extra work. The good news (such as it is) is that the Responsible Person is the only one held responsible under the law for ensuring that good EMC engineering practices ‘having regard to the state of the art’ are employed on their fixed installation.

So, if a consultant or contractor does *not* employ good EMC engineering practices in his work, whatever his contract with his customer he *cannot* be held liable under 2004/108/EC or the UK’s 2006 EMC Reg’s. However, the customer always has the option of suing the contractor, if he feels the work was not performed to the agreed specification.

Offering the Responsible Person EMC compliance services under 2004/108/EC provides an opportunity for the many professional M&E Contractors to distinguish themselves from their less-professional competitors, sometimes known as ‘cowboys’.

The problem with the less professional contractors is that because they are not so highly trained, competent, well-equipped, or knowledgeable about standards and regulations that apply, they can quote much lower prices – and some customers are bound to employ them (although they may regret it later on). The presence of such people in the market depresses prices generally, making it hard for the proper professional contractors to get a reasonable rate for the services they provide, in turn making it harder for them

to maintain their professionalism at the level that customers actually need.

At the time of writing, the vast majority of the owners of fixed installations are unaware even of the existence of 2004/108/EC, much less their legal duties under it. If contractors discuss their new EMC responsibilities with them, some will decide to purchase the additional good EMC engineering practice services offered by the more professional contractors despite the increased costs, and this might also reduce the cowboys’ incomes and hopefully reduce their numbers.

Increasingly, contractors are undertaking facilities management, so it seems possible that they might be appointed as the Responsible Person for the fixed installations they manage.

2.5 Apparatus intended for incorporation into a fixed installation

The apparatus used in a fixed installation could be apparatus as defined in 2004/108/EC that is placed on the EU market with a DoC and CE-marking.

But it could be apparatus specially made for that installation (typically: custom-engineered, bespoke, etc.) and ‘not otherwise commercially available to an end-user as a single functional unit’ (meaning that it cannot be purchased from a shop, warehouse, or a catalogue – it has to be made to special order for each installation).

2.5.1 CE-marked apparatus

A potential problem is that this apparatus may not have been intended for use in

the EM environment that obtains in the fixed installation, for example, a desktop or laptop PC used to control a heavy-industrial process will probably not be immune enough (even if the PC is put in a steel box for mechanical protection).

Another problem is that individually compliant apparatus might still cause interference problems within or outside a fixed installation, for example, if:

- The apparatus is very noisy Group 2 ISM equipment under EN 55011 [27]
- Two or more items of apparatus are used and their emissions aggregate
- The apparatus is used in a way that is not specifically addressed by its manufacturer's EMC installation and use instructions

The Responsible Person should make sure that the EMC compliance of the fixed installation is not compromised by purchased items of apparatus. He or she should be aware of the EM environment of their fixed installation and take necessary steps, not simply assume that because it is CE-marked it can be used without any additional EMC assessment or work.

2.5.2 Equipment custom-manufactured for a fixed installation

2004/108/EC [29] and its Guide [8] calls this type of equipment: "[Apparatus intended for incorporation into a specified fixed installation and not otherwise commercially available to an end-user as a single functional unit.](#)" – but this was too long for the title of this section. [4] and [9] call it 'certain equipment'.

According to the EC's Guide, for such 'bespoke' or 'custom-manufactured'

apparatus there will always be a direct relationship between its provider and its final customer. For such apparatus, the manufacturer can choose to apply a 'reduced compliance regime' (see Figure 3) that does not require:

- Compliance with any essential requirements
- Any conformity assessment procedure
- A DoC to be created or the CE-marking to be affixed

(but these may be needed by other Directives, e.g. the LVD [16])

But all such equipment must be provided to their end user with documents that:

- Identify the fixed installation it is intended for (e.g. by its street address)
- Identify the EMC characteristics of the fixed installation it is intended for
- Indicate the precautions to be taken when incorporating it into the fixed installation so that it does not compromise the installation's compliance
- Uniquely identify the item (e.g. its serial number)
- Give its manufacturer's name and address (or that of its agent or EU importer)

How much detail should the supplier's documentation go into? The EC Guide [8] gives these examples of information that should be provided:

- The required use of additional auxiliary devices (e.g. protection devices, filters etc.)

- The specifications and length of the cables required for external connections (and their connectors)
- The conditions for use (e.g. limits for proximity of walkie-talkies, cellphones, ISM equipment, etc.)
- Any special precautions for EMC (e.g. meshed bonding, etc.)

The UK's Guide [9] adds that the supplier must understand the nature of the fixed installation in sufficient detail to specify the precautions for incorporation to avoid compromising its EMC compliance.

However, it is important to understand that there is no obligation on the part of the owner or operator of the fixed installation, or of its Responsible Person, to provide any EMC information at all to anyone who is not from the EMC enforcement authorities. So they might deny the supplier the information he needs to use this reduced compliance regime.

Where it is impossible or impractical to determine the EM characteristics of the fixed installation in sufficient detail, the supplier of the custom equipment should apply the usual compliance regime to his apparatus, as if it was going to be sold through a high-street shop (Conformity Assessment, DoC, CE-marking, etc.).

The author has heard of some companies who manufacture custom-engineered equipment or systems, who intend to supply them to their end-users by treating them as fixed installations. But [19] made it quite plain that this is not a legal option.

Anything that is supplied to an end-user must either follow the compliance route that is specified in [1] and [4] for

apparatus (not discussed here, but see [30]) or else the compliance route for 'apparatus intended for incorporation into a specified fixed installation and not otherwise commercially available to an end-user as a single functional unit' – what [4] calls 'certain apparatus'. There are no alternatives.

2.5.3 Apparatus constructed professionally for 'own use'

According to the EC's Guide: if a company makes an item of equipment for its own use, then they are both manufacturer *and* end-user, so it is classified as either an 'other device, or as an apparatus – in which case all of the requirements of 2004/108/EC apply depending on whether it is classified as an 'apparatus', or as an 'apparatus intended for a fixed installation and not otherwise commercially available'.

This section discusses financial and safety implications, as well as providing some non-mathematical background to EM phenomena and EMC.

Later sections address the *practical* mechanical and electrical good EMC engineering practices that are relevant for fixed installations to better control EMI, and to help comply with the EMC Directive, future IEE Wiring Regulations and/or new lightning protection standards (see Section 2).

For more information on other EMI and EMC issues, such as management, planning, testing, and physical background see [31] [32] [33] [34] [35] [36] [37] and [38].

EMP and electronic warfare (see 5.13.4 and Section 6) are not the subject of this Guide, but the techniques it describes can be used for mitigating their EM threats.

3.1 Financial and safety risks controlled by good EMC engineering practices

Modern systems and installations are increasingly using continually advancing electronic technologies, especially digital processing, software, wireless and switch-mode power conversion (e.g. variable speed AC motor drives). These all create more EM disturbances, and at the same time they are more susceptible to EM disturbances, making EMI problems more likely. Also, their increasing complexity makes the discovery and solution of EMI problems much more difficult and costly.

[21] includes 500 examples of real-life EMI problems (a very small sample of the total), many of which relate to systems and installations of various types, and some of which concern incidents that had serious financial and/or safety consequences.

So it is becoming essential for reliability of operation (high uptime, low downtime) and the quality of the ‘finished product’ created by the installation (e.g. goods for sale, entertainment experiences, medical treatments, etc.) to control EMI for commercial and financial reasons.

Added to this is the regulatory requirement for the suppliers of products and systems, and owners of premises and sites in the European Union, to comply with the new EMC Directive [1], especially the very specific requirements for the use of good EMC engineering practices, discussed in Section 2 above. Being found to be non-compliant, and having your fixed installation switched off by enforcement agents, can have serious financial implications.

Remember that safety is always paramount, and should never be compromised by any EMC techniques.

A typical example of such a compromise is fitting EMI filters that cause high earth-leakage currents that increase safety risks – unless special high-integrity safety earthing/grounding methods are used.

However, it is very important to understand that (see 2.2) where errors or malfunctions in electronic circuits could possibly have implications for *functional* safety – merely complying

with [1] and passing its listed test standards will almost certainly not be sufficient to comply with the basic standard on functional safety [12].

Likewise, it will almost certainly not be sufficient either, for [13], [14] or safety regulations such as the Low Voltage Directive [16]; Machinery Directive [15]; and other safety Directives such as Lifts; Personal Protective Equipment; Potentially Explosive Atmospheres; the three Medical Devices Directives; or the Product Liability Directive [11] and the General Product Safety Directive.

Although the design and assembly techniques described here are often used to help achieve 'EMC for Functional Safety', a lot more is involved that is not covered by this Guide – for more information on this, see [5] [6] and [17].

Some systems and installations can be described as 'mission critical', and the financial, political, or other consequences of their failure to operate correctly can sometimes be as bad or worse than a safety accident. Such systems and installations should follow the good EMC engineering practices that are appropriate for controlling safety risks (also see 2.2) – but use them to control whichever risks are considered to be so important.

3.2 These techniques suit a wide range of applications

The good EMC engineering practices described in this Guide focus on industrial good EMC engineering practices, and since the same laws of physics (and hence of electromagnetics) apply to all types of electrical and

electronic assemblies, systems, and installations regardless of the purpose of their application, in *exactly* the same way, these practices apply regardless of application, from professional audio installations through hospitals and railways to space vehicle launch facilities.

I hope that the way I have written and illustrated this Guide makes the techniques it describes easy to apply wherever electrical and electronic installations are designed and constructed.

Even where electronic equipment (such as low-frequency analogue signal processing) does not employ or emit RF, the semiconductors they use (transistors, integrated circuits, etc.) will happily demodulate and intermodulate any RF noise that appears in their circuits, causing immunity problems, unless their manufacturers have taken great care in their EMC design. Many manufacturers do not take great care over immunity, because it adds to the cost, so even DC and low-frequency analogue electronics need to employ good EMC engineering practices in their systems and installations.

3.3 EM phenomena, EM disturbances, EMC test standards

EM disturbances have been mentioned several times above. An EM disturbance is any EM phenomenon that exists at a sufficient level that it could cause EM interference (EMI). Table 1 is a standard list of the types of EM disturbances that can occur.

Table 1 Overview of types of electromagnetic disturbance phenomena (from [17])

Conducted low frequency phenomena	Harmonics, interharmonics Signalling voltages Voltage fluctuations Voltage dips and interruptions Voltage unbalance Power frequency variations Induced low frequency voltages d.c. in a.c. networks
Radiated low frequency field phenomena	Magnetic fields ^a Electrical fields
Conducted high frequency phenomena	Directly coupled or induced continuous voltages or currents Unidirectional transients ^b Oscillatory transients ^b
Radiated high frequency field phenomena	Magnetic fields Electrical fields Electromagnetic fields – continuous waves – transients ^c
Electrostatic discharge phenomena (ESD)	Human and machine
Intentional EMI ^d	
High altitude electromagnetic pulse (HEMP) ^d	
^a Continuous or transients. ^b Single or repetitive (bursts). ^c Single or repetitive. ^d To be considered in case of special conditions. NOTE: There is no abrupt change between the low frequency domain and the high frequency domain but a soft transition between 9 kHz and 150 kHz. For formal applications the limit is set at 9 kHz (the scope of CISPR).	

Of course, whether an EM phenomenon could actually cause EMI depends upon the susceptibility of the equipment concerned to that phenomenon. For example:

- **Electromechanical devices** (switches, relays, contactors, solenoids, residual current detectors, under/overvoltage relays, phase rotation relays, circuit breakers, etc.) are especially susceptible to surge overvoltages that can cause sparking

across open contacts, and surge overcurrents that can weld closed contacts together.

Any device that relies on energising a coil (relay, contactors, solenoid, etc.) is also susceptible to dropping out due to poor quality of its electrical power supply, in particular its voltage, dips, dropouts, frequency. Its susceptibility gets worse as the temperature of its armature increases, and relays/contactors that are 'held in' by a normally-open contact will not automatically recover after a momentary dropout.

- **Analogue transducer amplifiers and similar** are typically very susceptible to continuous EM phenomena, from DC up to several hundred MHz. Electrostatic discharges (ESD), transients, surges, and dips/dropouts in the electrical power supply cause a momentary error to occur in their output, which can often be ignored by appropriate programming of the subsequent digital system (as long as that do not cause actual damage to the amplifiers).
- **Digital processing** is typically very susceptible to ESD, transients, surges, and dips/dropouts in their electrical power supply. Where software or firmware is employed it is not unusual for complex malfunctions to result, sometimes involving overwriting of programme memory, and the processor may also cease processing (often called a 'freeze' or 'crash') and need to be rebooted (maybe after manually reloading its software).

With well-designed digital circuits, continuous EM phenomena need to be at quite a high level before they cause similar problems, although close proximity of portable mobile transmitters such as cellphones, walkie-talkies, etc., is capable of exceeding such levels.

REO (UK) Ltd have published a series of 17 EMC Guides [37], which describe how electromagnetic (EM) phenomena arise (i.e. what causes them) and how they can cause problems for electrical and electronic devices and circuits and the applications they are used in. Another useful reference on EM disturbances is [39].

The REO Guides also describe the European EMC test standards, which are based on international standards developed by the IEC, and how to test using them. All of these standards are intended for testing items of equipment, and there are no published standards for testing systems or installations.

Many companies do their own EMC testing according to European or International standards. There are many easier, quicker and less costly ways to do EMC testing, but they are less accurate and not as useful for proving legal compliance. However, they still have value in assessing the suitability of supplier's products, design and development, fault-finding and problem-solving, checking workmanship standards and other QA activities. For more on low-cost testing, see [40].

On-site ('in situ') test methods *do* exist for testing equipment outside of the carefully-controlled EM environments in EMC test laboratories, and so can be used to test systems and installations. Examples of *in-situ* methods that can be

used to verify EMC design and assembly, and can also help support a claim of EMC compliance, are given in [41], and [27] and [28] are also relevant.

3.4 The basic EMC theory (with almost no maths)

This Guide focuses on practical tips and techniques, and does not try to explain *why* they work. This approach can leave engineers vulnerable to special situations where an unusual approach may be needed, but trying to convey the theoretical understanding required to devise special techniques is outside the scope of this Guide, and many practicing engineers would find it very tedious anyway. So this Guide suggests reading the references in Section 10, and then reading *their* references if you still need more background. But here are a few of the reasons why these EMC techniques are needed:

- *All* modern electronics – especially digital, switch-mode, and wireless – employ a wide band of frequencies from audio up to at least 100 MHz, maybe even up to several GHz (thousands of MHz). For them to operate correctly and to achieve EMC it may be necessary to control some or all of their frequency range by using EMC techniques in their cabling and assemblies, and in the cabinets that house them.
- *All* conductors have significant impedance at frequencies above a few 10s of kHz, caused by skin effect (which increases their resistance) and inductance. Inductance (L) is typically 1µH/metre for an ordinary wire (e.g. a green/yellow insulated wire), giving a reactance of $2\pi fL$

ohms at frequency f (e.g. 63 Ω/m at 10MHz).

The result is that wires (even ones with green/yellow insulation) *cannot* be used to provide an effective circuit reference voltage at frequencies above a few hundred kHz (usually much less), and so can't provide any EMI control at RF.

- *All* conductors – such as metalwork, wires and cables – make good 'accidental antennas', and so leak a proportion of the power and/or signals they carry into their external environment. This is especially the case where the conductors are longer than one-tenth of a wavelength ($\lambda/10$) at the highest frequency of concern. The wavelength $\lambda = 300/f$ when the frequency f is given in MHz.
Accidental antenna behaviour is a common cause of EM emissions and immunity problems. Cables can be shielded to reduce their antenna efficiency, but it is never 100% effective and if done incorrectly (e.g. cable shield bonded at only one end) it can have no benefits at RF, and could even be worse than having no shield at all.
- *All* conductors, such as metalwork, wires and cables, make good accidental antennas, and so pick-up a proportion of the EM energy in their external environment and so add voltage and current noise into the signals and power they are carrying. This is especially the case where the conductors are longer than $\lambda/10$ at the highest frequency of concern, and is a common cause of EM susceptibility (immunity) problems.

Shielding can be used to reduce this effect, but it is never 100% effective and if done incorrectly (e.g. shield bonded at only one end) can make the problem worse.

- All conductive structures – typically called ‘earths’ or ‘grounds’ – become ineffective above some frequency related to their dimensions and method of construction. Above this frequency they no longer provide a stable or effective circuit reference voltage – in fact, they become accidental antennas instead of

‘grounds’. At such frequencies they cannot provide EMI control – and may even add to EMI problems.

The problems caused by accidental antennas are illustrated in Figures 5, 6 and 7, which show how the typical wire and cable lengths used in installations (300 mm to 100 metres) can cause the electrical energies they carry (whether as signals or power) to interfere with the radio spectrum that is vital for broadcasting and communications.

Figure 5 The frequencies we use

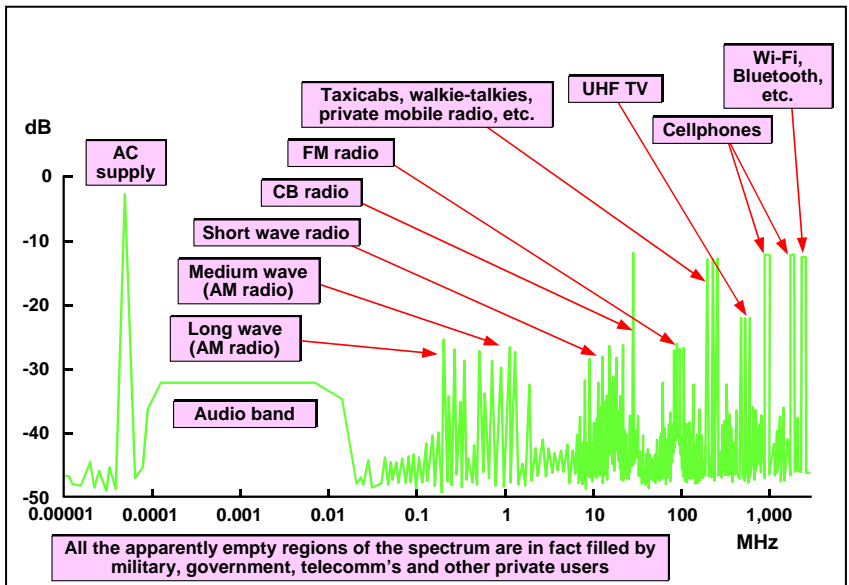

Figure 6 Plus the noises emitted by electrics/electronics

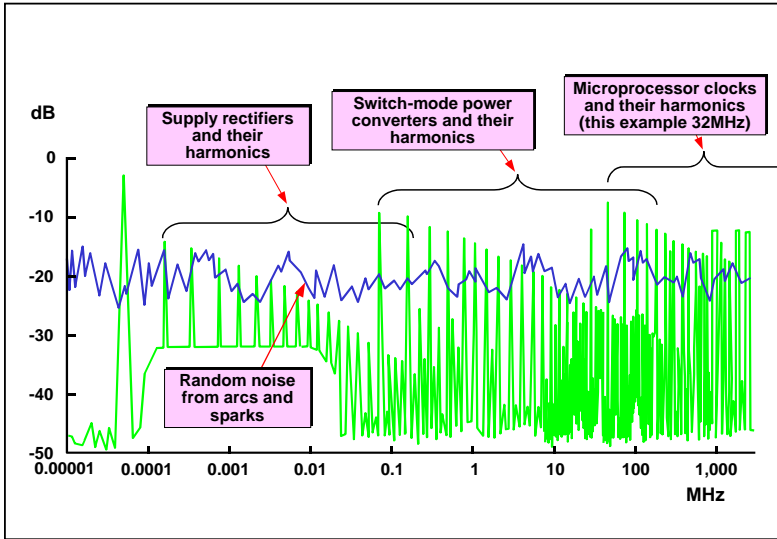
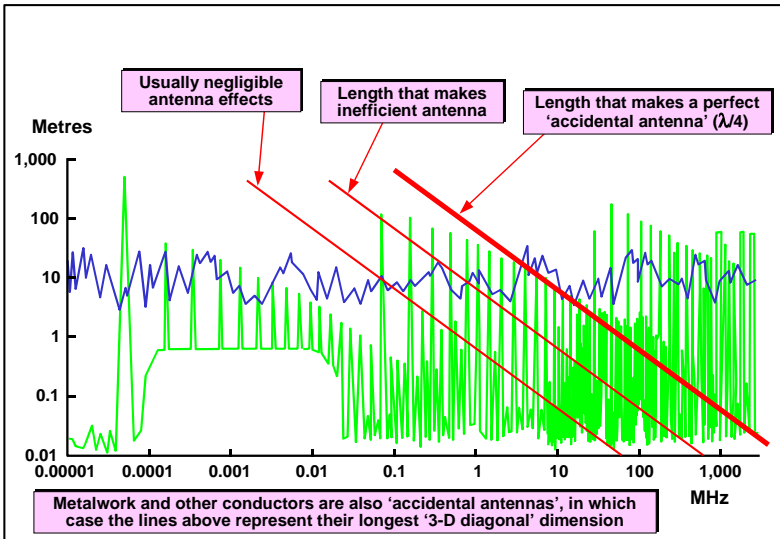

Figure 7 All conductors are accidental antennas



The words 'earth' and 'ground' are very much misused in electrical and electronic engineering, leading directly to a great deal of confusion, delay and unnecessary extra costs. This Guide strongly recommends that these words are *never* used, except when referring to an actual earth or ground electrode that is buried in the soil under or around a site.

This Guide will *try* to take its own advice (but probably not succeed entirely) and use more accurate and explicit terms such as: chassis or frame; shielded (shielded) enclosure; protective earthing conductor (the green/yellow wire in mains cables, used for safety purposes); Common Bonding Network (CBN) for what is often called a site's protective earthing/grounding system; and of course: **Reference**.

As has been implied above, correct circuit operation and good control of EMI and the achievement of EMC requires that we understand how to design and create a Reference that is effective over the full range of frequencies we need to control, especially RF (frequencies above 150kHz). In some other publications the Reference is sometimes called the RF Reference, Reference Plane, RF Common, or other terms such as 'EMC Earth' or 'EMC Ground'.

To be effective, an RF Reference must have very low impedance over the frequency range to be controlled, much lower than the impedance of the capacitors in any EMI filters (i.e. $\ll 1\Omega$). The only kind of structure that can achieve low enough impedance is a metal mesh, ideally a metal sheet, which is why RF References are often called RF Reference Planes.

An RF Reference must always be physically close to the circuit that relies upon it for operation or EMC – much closer than $\lambda/10$ at f_{\max} : the highest frequency to be controlled (ideally $\lambda/100$ or even less, e.g. $< 30\text{mm}$ for frequencies up to 100MHz). This is because of all of the conductors, including large pieces of metal with negligible resistance, that might be used to connect the circuit to the RF Reference suffer from inductance and accidental antenna effects at longer distances.

Since $\lambda = 300/f$ (f in MHz gives λ in metres) we can write $\lambda/10$ at f_{\max} as $30/f_{\max}$, and $\lambda/100$ as $3/f_{\max}$.

A metal box of whatever size (e.g. a shielded room) can be used to shield a cable or item of equipment from its external EM environment, but its metal surfaces can only be used as the RF Reference for that cable or equipment if it is much closer than $\lambda/10$ (or $30/f_{\max}$).

3.5 Single-point earthing/ grounding is no use for EMC at all

It should be obvious from the above that the traditional but long-outdated electrical installation practice of 'single-point earthing' (or grounding or bonding) is counter-productive when it comes to EMC. In fact it is almost as if whoever introduced it was trying to ensure that EMI and even reliability in electronic installations (e.g. due to surge overvoltages) was as bad as was humanly possible.

Single-point earthing/grounding/bonding attempts to control the flow of currents in the earth/ground structure by providing each item of equipment (that is not double-insulated and therefore

unearthed) with a dedicated green/yellow insulated protective earthing conductor in its mains cable. Each equipment's protective earthing conductor connects only to the main earthing terminal for the vehicle, vessel, building or site, which is called the single-point earth/ground point (sometimes: 'star earth/ground').

No other electrical connections are permitted between the chassis/frames/enclosures of the items of equipment, so that stray currents in the earth/ground structure do not create 'earth loops', 'ground loops' or 'hum loops'. This of course means that shielded cables can only have their shields terminated at one end – a practice that immediately robs the shield of any effectiveness above a few 10s of kHz, and can even make EMC worse because the shield can then behave as an accidental antenna as shown in Figure 7.

Unfortunately, single-point earthing/grounding/bonding when used in a system or installation with conductors that are at least a few metres long, is physically unable to control where currents flow above a few 10s of kHz, and above a few MHz all of the protective earthing conductors become very effective accidental antennas indeed (see Figure 7).

So, where this Guide uses the term CBN or RF Reference (or even earth or ground) it means a structure that has a degree of meshing, or cross-bonding, intended to control a certain range of frequencies.

Some publications use the term 'equipotential bonding' to mean a mesh-bonded or cross-bonded structure, but unfortunately, like the terms 'earth' and

'ground', it has been misused and so is best avoided. For instance, an electrical contractor would typically assume that 'equipotential bonding' meant a protective bonding (safety earth) system that did not produce unsafe voltages during an electrical fault – essentially voltages that did not exceed 50V rms at 50Hz.

Single-point earthing/grounding/bonding structures are never assumed, proposed or recommended anywhere in this Guide – although now and again the (usually dire) implications of single-point earthing/grounding/bonding for a particular EMC characteristic will be mentioned.

5.8 goes into some detail describing why the earth/ground/hum loops resulting from cross-bonded or meshed CBNs are beneficial *in every way*, and will reduce EMI and 'hum' or 'buzz' noises rather than increasing them, as long as the electronic input/output circuits connected to cables are designed appropriately (as they will almost certainly be for every item of equipment that would pass the entirely reasonable immunity tests that are listed under the EMC Directive). It also describes how to deal with products and equipment that have not been correctly designed for systems and installations, for which their manufacturers specify the use of single-point earthing/grounding/bonding techniques, such as terminating cable shields at one end only.

How best to deal with upgrades, modifications or additions to legacy installations that are claimed to employ single-point earthing/grounding/bonding is dealt with as required in the appropriate sections of this Guide.

3.6 Don't rely on CE-marking

When constructing a system or installation, do not rely solely on the CE-marking of its apparatus. The 'CE + CE = CE' approach assumes that as long as the component parts used are all CE-marked and bought 'in good faith', then the installation as a whole will comply with all relevant Directives, *but this has no technical or legal basis* (see 2.3.4). If a supplier has lied or made a mistake about the compliance of his product, and this causes an installation to become non-compliant, the law holds both parties to be at fault – the Responsible Person cannot simply pass responsibility onto suppliers – he or she is expected to take appropriate steps to verify that their purchases meet their specifications, and/or that their installation complies.

Experience all over the world shows that it is very rare indeed for an installation constructed from CE-marked apparatus to actually meet the relevant EMC standards if it is tested. [18] goes into this issue in detail, showing how to spot many of the tricks that some manufacturers use when CE-marking their products, and warning of the pitfalls that can compromise the EMC of the system or installation it is used in, even when all the components used in the cabinet have excellent EMC compliance individually.

Perhaps it is not surprising that the CE + CE = CE approach does not work in practice, when one considers that recent EC data [20] indicates that about 33% of all CE-marked goods supplied in Europe do not comply with the Directives they are supposed to.

3.7 Following good EMC practices

In the kinds of residential, commercial, and industrial EM environments that are addressed by the generic EMC emissions and immunity test standards in the series IEC/EN 61000-6-1 to 61000-6-4, or similar test standards, most EMC problems can be solved by:

- Taking care to only utilise electrical/electronic equipment that have proven good EMC performance (see [18]) when tested to those standards or tougher ones
- Obtaining and fully applying their supplier's EMC instructions in design and construction
- Taking account of the build-up of emissions caused by having multiple units [42]

It is still advisable to employ the good EMC practices in this Guide wherever suppliers provide EMC instructions, to help resolve conflicts between different units' EMC instructions.

However, most normal EM environments are worse than the ones described by the generic or similar test standards, because those standards specifically do not cover the situation where portable radio transmitters are used nearby – which is now commonplace in all environments, and cannot be controlled without very stringent security measures. The standards also ignore a number of other EM environmental situations that can easily occur, such as the proximity of Group 2 ISM equipment (see 2.3.9), or electric welding. So in almost all real-life situations, and especially in certain industrial, medical, scientific or military sites where the EM environment is more extreme than usual, the use of good

EMC engineering practices can be very important indeed for preventing costly problems due to EMI.

Good EMC practices in the construction of electrical and electronic systems and installations have been known for decades, and are continually evolving to cope with the increasing frequencies being generated by modern electronic technologies, especially digital processing, switch-mode power conversion, and wireless voice and data communications. Relevant standards and public-domain documents on good EMC engineering practices include [43] [44] [45] [32] and Part 5 of [38], and there are a number of guides to good practices produced by companies that sell industrial components, such as [46] and [47].

These days, good EMC practices are often different from traditional electrical assembly and installation practices. In some long-established industries large amounts of money and time are still needlessly wasted, because of an apparent reluctance to learn about EMC or modern techniques. Instead of dealing with the foreseeable EMC problems in the original design and construction, they just attempt to fix any EMC problems with the systems and installations that arise during operation. It is often the case that operational problems aren't recognised as being EMC-related for some time, and even then take a long time to fix, making them very costly.

In some industries there are people who specialise in fixing operational problems, which they usually identify as signal quality issues such as 'mains hum', 'ground loops' or 'noise breakthrough' rather than EMC. Since the use of

modern good EMC engineering practices threatens their livelihoods they generally argue against their use, encouraging manufacturers and systems integrators to continue using the outdated traditional practices (such as using single-point earthing, and bonding the shields of cables at only one end) that keeps them in work.

Part of good EMC practice is to follow the EMC instructions provided by the manufacturers of the electronic units that are to be used – but only where these are reasonable and don't conflict with what is written in this Guide, or with other manufacturers EMC instructions.

Where manufacturers' instructions differ or conflict, EMC expertise is needed. For example, some suppliers specify that shielded cables must have their shields bonded to 'earth' at only one end, and they often provide a screw-terminal for that purpose. While this may *sometimes* be acceptable these days in some special cases, it will generally prevent typical systems and installations from passing the relevant emissions and/or immunity tests, and can therefore lead to inaccurate or unreliable operation as well as non-compliance with legal requirements.

Such poor EMC instructions are mostly due to a lack of knowledge and/or poor design of the electronic circuits used for the inputs and outputs. They are usually written by companies who have not tested emissions and immunity, or not tested them properly, or tested them using unrealistic set-ups. They slavishly repeat the bad instructions in their manuals, believing them to be good EMC practice because someone told them so 30 years or more ago.

Good EMC practices should generally be followed for all installations, to help the purchased electrical and electronic apparatus achieve the EM performance they are capable of, and to help EM mitigation measures (e.g. filtering, shielding and transient overvoltage suppression) achieve their desired performance. These techniques require additional effort and skill in design, but generally cost little and add very little time in assembly.

3.8 Communicating good EMC techniques

Many companies have problems in turning the intentions of their designers into actual constructions. Nowhere is this more evident than in EMC, where apparently small variations in cable length or route, or equipment placement, can make huge differences to the EMI caused or suffered.

This situation is not helped by the apparently almost total lack of understanding of good EMC engineering practices amongst architects, electrical consultants, system integrators and M&E contractors. The author feels sure that those who develop their skills in this area will win many contracts from installation owners or operators aware of their legal obligations under 2004/108/EC [1] [8] and its associated UK EMC Regulations [4] (see Section 2).

Also, they should more easily win contracts from installation owners or operators who have suffered significant financial losses due to EMI and do not wish to repeat the experience.

But even where the above people do have the necessary EMC skills, the Responsible Person for the EMC of the

fixed installation (see 2.3.8) still needs to communicate to them which – of the many techniques available – need to be employed.

So it is important – to save time and money – that companies find ways to communicate the necessary good EMC practices to everyone who needs to know, including those doing the construction.

Ideally, the various good EMC assembly and construction techniques would be documented as Work Instructions under a QA system, and then referenced by the designers on their drawings wherever they need to be applied. Some companies use the graphics that appear in this Guide as their Work Instructions, and the author will be pleased to provide these graphics for such purposes, on request [48].

3.9 An overall EMC procedure

A general procedure for managing EMC to achieve reliable performance and legal compliance, and reduce financial risks, for a system or fixed installation is shown in overview in Figure 8:

Figure 9 goes into a little more detail about the elements of Figure 8 that are concerned with the specification and selection of equipment to be incorporated into the system or

installation. It shows how the combination of EM mitigation measures and equipment EM performance achieves the EM emissions and immunity specifications for the overall installation. It is generally best to purchase equipment that allows the system or installation to achieve its EM specifications without the need for additional EM mitigation, but unfortunately this is not always practical.

Figure 8 Overview of a general procedure for achieving EMC

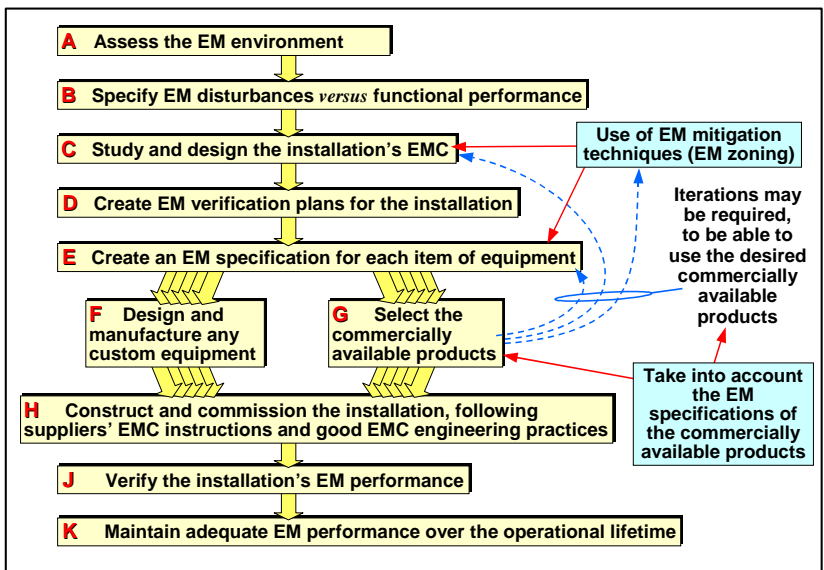
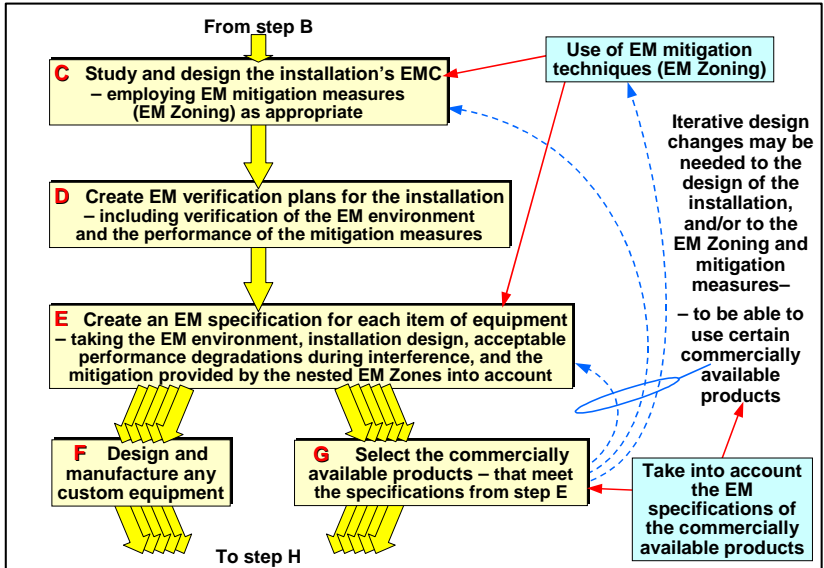

Figure 9 Overview of a general procedure for specifying and selecting equipment



The following sections of this Guide are concerned with the activity represented by boxes C and H in Figure 8. A detailed discussion of the other elements in Figure 8, or Figure 9, is outside the scope of this Guide, but the references at the end will provide a great deal of relevant information.

4.1 Power distribution systems for EMC

A number of different types of power distribution systems exist, for example TN-S, TN-C, TT, IT, etc. TN-C types, also known as PEN (Protective-Earth-Neutral) combine the functions of Neutral conductor and protective earth in one conductor, and are bad for EMC because they cause signal and data cables between items of equipment to experience high levels of noise at 50/60Hz and their harmonics. They also create strong magnetic fields throughout an installation at 50/60Hz and their harmonics, that make the images on VDUs and photo-multiplier tubes 'wobble', and can also interfere with sensitive electronic circuits.

So power distribution systems that use a single conductor for the neutral and the protective earth should not be used wherever signals, data, VDUs, photo-multipliers, or sensitive electronic or electrical equipment is used, such as equipment that complies with the product or generic immunity test standards used for compliance with the EMC Directive [1], which do not test at all for this kind of EM environment.

Where TN-C (PEN) systems are used, they can be converted to the EMC-friendly TN-S types by installing a suitable mains isolating transformer at the boundary of the area to be protected (see 4.6), and only supplying mains power to that zone from its TN-S output. The neutral of the TN-S supply must be connected to the BRC for the areas (see 4.7), and must not have any other

neutral-CBN connections anywhere else. It is good installation practice to fit a link in the neutral-BRC bond, and before commissioning, during annual shutdown or when problems are suspected, isolate the power source, remove the link and check there is now no resistive path from the neutral to the CBN. The equipment in the zone should be plugged in during this test, to discover if any of them is suffering a neutral-to-chassis insulation failure.

TN-C, PEN and similar distribution systems do not create interference problems where all of the electronics or other circuits are insensitive to the EM disturbances they create, or have been specially 'hardened' to operate reliably in an environment containing high levels of conducted electromagnetic disturbances, and high levels of magnetic fields, at the power line frequency, its harmonics, and its load currents.

All other types of AC power distribution have no EMC effects, as long as they don't prevent the use of the good EMC engineering practices and EM mitigation techniques described in this Guide.

4.2 Improving power quality

Non-RF power quality issues include:

- Sags, brownouts, swells, dips, dropouts, variations, flicker, short interruptions, long interruptions
- Harmonic and inter-harmonic waveform distortion
- Common-mode (CM) voltages on phases and neutrals, DC – 150kHz

How these EMC issues can arise in real life, what they can affect, and how to deal with them is covered in two REO booklets, “Power Quality” [35] and “Mains Harmonics” [34], and they are not covered further in this Guide.

4.3 Galvanic isolation for EMC

4.3.1 Galvanic isolation for signal, control and datacommunications

As 3.4 and Figure 7 show, all cables and other conductors (including ‘earth’ wires, metal brackets and panels) behave as ‘accidental antennas’. They leak the power or signals they carry, causing emissions, and they carry conducted noises and pick up EM fields from their environment, causing interference and immunity problems. This is not what we want cables and other conductors to do, but if we use metal conductors there is no way of preventing this, other than using the EM mitigation techniques: galvanic isolation; shielding; filtering; surge and transient suppression, which all add cost.

There is always impedance in a CBN, so the ‘earth leakage’ and occasional ‘earth fault’ currents emitted by electrical/electronic equipment; surge currents caused by lightning; and induced currents caused by transmitters or high-power processes, generate voltage differences between the chassis/frames/enclosures of widely-separated items of equipment. These voltage differences appear to the input and output drivers of the interconnecting cables as CM noise, over a very wide range of frequencies, which can be capable of interfering with their signals, or even damaging the driver devices themselves.

Well-designed equipment deals with this by using ‘balanced’ signalling with transformers to provide galvanic isolation that attenuates the low-frequency ‘earth potential differences’, and RF filters to attenuate the RF earth potentials, all rated to withstand the highest surge overvoltages that are anticipated. But these techniques add cost and some manufacturers improve the (apparent) competitiveness of their products by using cheaper and less robust interconnections, which can be difficult for the inexperienced designers, specifier or purchaser to identify.

One way of dealing with this potential problem is to design and construct a low-impedance CBN using meshing techniques, discussed in 5.5. But this is not a cost-free exercise, especially for legacy installations, although appropriate use of existing metalwork and structures can help keep costs low.

Galvanic isolation transformers can be added to equipment, a common solution for sensitive analogue audio signals in professional audio installations.

But the most cost-effective and certainly the easiest and most trouble-free good EMC practice is to use fibre-optics to carry analogue, digital or control signals, instead of cables or other conductors. The fibre-optic cables do not behave as accidental antennas, they provide galvanic isolation that completely ignores any electromagnetic disturbances occurring in the CBN, at any frequency, and they can handle huge data rates.

It is even possible to supply a few Watts of electrical power via fibre-optics, enough for some instrumentation applications. Although the purchase price of the fibre-optic components and

cables makes them appear to be more costly than metal conductors and their connectors, the EMC problems associated with cables and conductors generally makes fibre-optics much more cost-effective over the lifetime of an installation.

Of course, the fibre-optic receivers and transmitters need to have adequate EM performance for both emissions and immunity, but they are just small devices that are easy to shield and filter on their printed circuit boards (PCBs).

Using metal conductors in an installation, discovering that they cause an EMI problem, then stripping them out and replacing them with fibre-optics, is always going to be a very costly undertaking. So it can be good risk-avoidance practice to use fibre-optics whenever there is a possibility that metal conductors could cause EMI problems.

There are signalling protocols appropriate for sending any kinds of digital signals over fibre-optics, from multi-channel professional audio to Gigabit Ethernet. 'Stage boxes' that accept dozens of microphone inputs and communicate them to a digital-processing sound mixing desk via a single long fibre-optic cable, were first designed and used in the early 1980s specifically to save overall project cost whilst also improving sound quality by reducing interference. The use of fibre-optic fieldbusses with de-centralised instrumentation and control panels is now commonplace in processing industries where there is a lot of electrical noise and/or the cost of downtime is high, such as paper mills and steel foundries.

Some fibre-optic cables contain metal (e.g. draw-wires, vapour barriers,

armour) that can suffer from dangerous voltages; can compromise shielding; and may not be robust enough to take ground fault and surge currents. So it is best to use metal-free fibre-optic cables, or otherwise treat their metal as if it was a thin bonding wire, using appropriate techniques discussed elsewhere in this Guide.

Optocoupler (optoisolator) devices are like very small sections of fibre-optic packaged inside a tiny PCB-mounted device. They are often used at the inputs and outputs of equipment. Another galvanic isolation technique often used on PCBs or in equipment is the isolated contacts of relays (often called 'volt-free relays') or contactors.

Wireless (radio), guided or free-space microwave, free-space laser and infrared datacommunications are also generally better for EMC than cables or other metal conductors, and may be considered a viable alternative to fibre-optics. Because they do not require any cables to be pulled, they can be quicker to install and help keep the overall project cost down, and they have no cables to be damaged.

In the past, building structures, machines and other equipment would often block wireless signals, and radio interference could occur, both problems being especially common in industrial environments. So radio communications has not been widely adopted despite the many benefits of not having any cabling. But at the time of writing there are a number of manufacturers offering wireless data communications systems that they claim use advanced signal processing techniques that take advantage of reflections and improve resistance to interference, to provide

robust wireless datacommunications even in most industrial environments.

Guided microwave techniques use metal pipes called waveguides to carry GHz radio signals over almost any distance, and easily cope with corners and even rotary joints. The waveguides are metal, and to achieve galvanic isolation they need to have one or more insulating spacers inserted at waveguide joints. Free-space microwave uses dish antenna to send GHz radio signals in narrow beams in a line-of-sight configuration. By using relay stations, which could be terrestrial or satellite-based, free-space microwaves can be used to communicate between most buildings, and for many years was the main 'backbone' of the telecommunications network in the UK and many other countries.

Infra-red communications must always be line-of sight, which can place limitations on its use, but there are systems which sprinkle numerous devices all over the ceiling so as to allow unhindered voice and datacommunications all over a site. Infra-red systems designed to replace wireless handsets in explosive atmospheres (and other areas where their use could cause problems) have been commercially available for years.

4.3.2 Galvanic isolation for electrical power

Galvanic isolation of the electrical power supply is a very powerful EMC technique, and can be achieved using isolating transformers (special high-isolation types are available), motor-generator sets, and isolating continuous on-line double-conversion uninterruptible power supplies (UPSs). [34] and [35]

describe these techniques from the point of view of improving power quality at frequencies below 150kHz, but they are equally applicable at higher frequencies, providing the devices used are appropriately specified, designed and proven by testing.

For example, a typical mains isolating transformer or continuous on-line double-conversion UPS might only provide a high degree of attenuation for conducted EM disturbances on the mains supply up to a few 10s of kHz, but if they are designed appropriately, with appropriately-designed shields in their transformers and careful segregation of input and output cables, they can achieve up to 80dB of attenuation from DC to over 1GHz.

4.3.3 Surge voltage ratings for galvanic isolation

Where galvanic isolation mitigation techniques are used at the boundary of an EM Zone (see 5.4), they must be rated for the maximum surge overvoltage expected due to lightning, or faults in the LV, MV or HV mains distribution networks, or any other sources of overvoltage (see 5.13.5) in the zone or its neighbouring areas.

The mains power distribution authorities have this well in hand, and the distribution transformers they supply, that transform from HV or MV to LV (230/400V rms) are rated accordingly. Within a vehicle, vessel, building or site where techniques described in this Guide have been applied, surges can be controlled to whatever level is desired.

But big problems arise when any cables interconnect buildings on a site, where the whole site was not protected as an

entity, for example by enclosing it in an EM Zone 1 (see 5.4) with appropriate mesh-bonding over the whole zone (see 5.5).

Electrical faults, and especially lightning strikes to individual buildings that have not benefited from such an approach, can cause their interconnecting cables to suffer surges measured in MV, which are capable of 'flashing over' to other conductors that are even as far away as 2 metres. **This raises very serious issues for human safety, property damage (e.g. fire), and equipment reliability, which should never be underestimated.**

Galvanic isolation techniques that could be subject to such voltages, must be rated accordingly. Optocouplers, optoisolators, relays, contactors and isolating signal transformers will generally withstand a few hundred volts between their inputs and their outputs, which is generally only adequate for interconnections within the cabinet of a single item of equipment, although they might be acceptable in a very well-controlled EM environment such as might be found in an EM Zone 2 or higher (see 5.4).

Types that are rated to withstand input-to-output voltages of *at least* 1.5kV rms, 2kV peak or surge are generally required for use within an EM Zone 1, or within an area protected by a BRC as described in 4.7, but some vehicles, buildings or sites might require ratings of at least 10kV peak (especially where the installation uses single-point earthing/grounding techniques, see 3.5).

But fibre-optics, free-space microwave or laser, and infra-red galvanic isolation techniques can easily cope with any surge overvoltage between their input and output devices – the only

recommendation is that there is a completely empty air gap of at least X metres between any conductive parts of the input and output devices (e.g. antennas, metal draw-wires in fibre-optic cables, microwave dishes, etc.), where X is at least five times the maximum overvoltage to be withstood expressed in kV, to cope with damp conditions, rain, snow, etc. For example, to withstand 2MV, the shortest path through the empty airspace between the input and output devices should be at least 10 metres.

Like everything else in this Guide, the information and guidance provided here is just general good practice. Where there are significant safety, financial or political risks that could be affected by anything covered in this document, design and construction should be based *solely* upon a competent and detailed analysis of the application concerned, and should not use these guidelines unquestioningly as if they were some sort of rule.

4.4 Routing send and return current paths together

The laws of physics mean that there are always return currents associated with any type of electrical or electronic signal or power, with any type of electrical or electronic load. For good EMC the 'send' and 'return' currents should have dedicated conductors that are routed as closely together as possible. Cables that twist the send and return conductors as twisted pairs, triples, quads, etc., are generally the best.

Busbars cannot be twisted, so are best spaced very closely together spaced by thin layers of solid dielectric.

Figure 10 shows preferred and non-preferred routes for switches in a lighting circuit, or when relays or contactors in a control panel switch one of the power conductors, for example. It also shows the desired routing of analogue or digital signal conductors close to their return path, even if it means adding extra conductors that appear to create a 'ground loop'. ('Ground loops' are a good thing for EMC, and do not cause problems for correctly-EMC-designed electronics, see 5.8.) These principles apply whatever electrical signals or power a conductor may be carrying,

from weak transducer signals, through high-speed data, to electrical power. Above a few kHz, the return current will automatically take the path of least *impedance* (not resistance), which is also the path that gives the least accidental antenna effects, and this will be along the conductor that is physically closest to the send conductor over its route. (Above a few kHz the resistance of the conductors is not important, the path taken by the return current depends on the impedance created by inductance and capacitance, including 'stray' inductance and capacitance.)

Figure 10 Always route send and return current paths close together

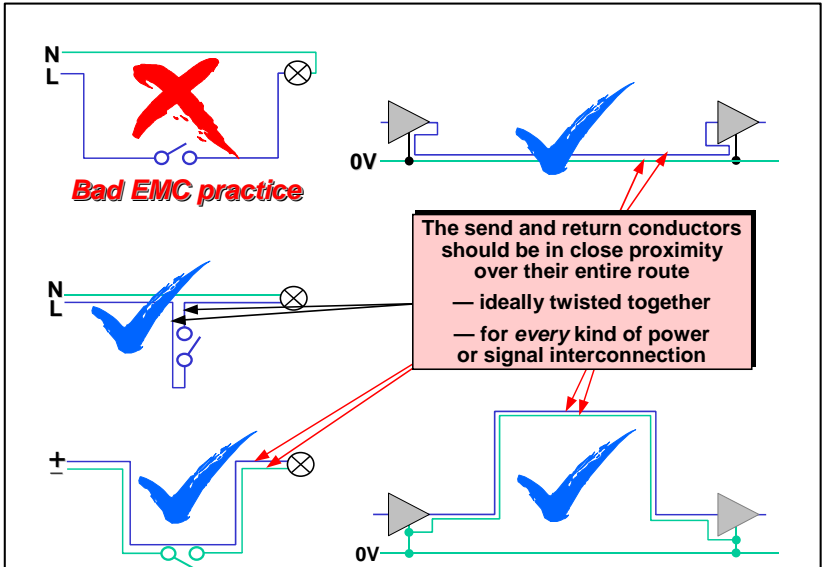

Twisting the send and return conductors helps ensure that the send and return currents both follow the same route, and its reversal of the orientation of the

conductors every half-turn reduces their emissions of (and susceptibility to) differential-mode (DM) and common-mode (CM) EM fields. So twisted-pair

cables are always preferred (or twisted triples or quads, whatever it takes to get all the send/return paths associated with a circuit into close proximity along their length).

Flat ribbon cables are often a cause of EMI problems with both emissions and immunity, and Figure 11 shows two examples of ribbons that have had their EM characteristics improved by routing send and return conductors on adjacent conductors. A send/return pair in a ribbon cable will still have very inferior EMC performance compared to a twisted pair.

Bundles of individual straight conductors will have worse EM characteristics than

the ribbon cables shown in Figure 11, because bundling does not maintain the send and return paths for a given power or signal together all along their route – the individual conductors tend to lie in the bundle in a random manner.

The CM fields associated with the bundles can be reduced by adding extra conductors into the bundle, and bonding them to the chassis/frames/enclosures of the equipment at both ends of the bundle – the more bonding conductors the better. These bonding conductors could form part of the protective (safety) bonding network or not (in which case they are known as functional bonding conductors). See [49] for more detail.

Figure 11 Some practical examples of routing send and return current paths close together

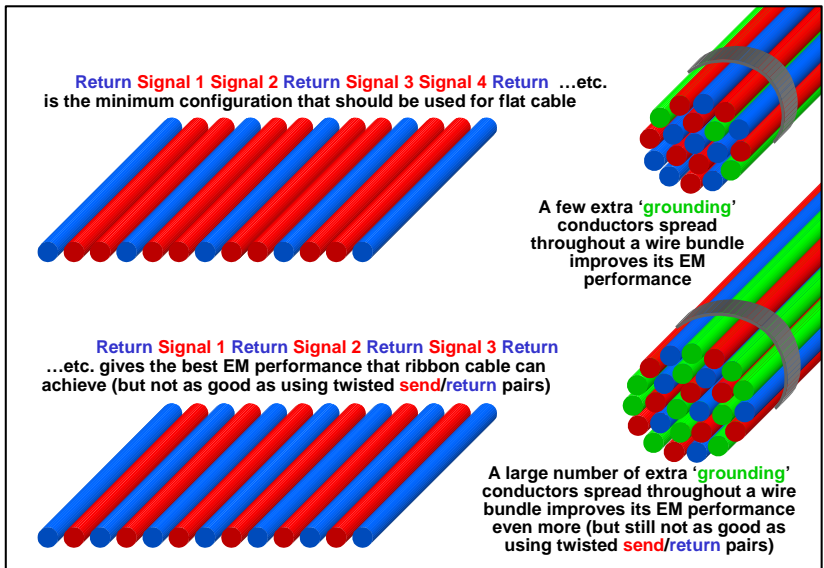

As long as the protective bonding and protective earthing conductors in the

system or installation are designed and constructed so that they can safely carry

the maximum fault (and/or lightning surge or EMP) currents, and are not damaged by them, the cross-sectional area and current capacity of any other copper bonding conductors connected in parallel with them and routed in parallel with them along their length is not important. Fault currents will divide up according to the resistances of the conductors, so if a large diameter copper wire is in parallel with one of much smaller diameter, the heating effect in each will be the same. So if the large one is rated adequately, the smaller one is protected.

Where single-point protective earthing is used (see 3.5), a copper conductor of smaller cross-sectional area that *does not follow the route* of the protective conductors will create a 'bridge' between two different 'arms' of the protective earthing network and so should be adequately rated to carry the possible fault (and/or lightning surge) currents that could flow in it.

Of course, conductors that link different parts of the 'earth' 'ground' or protective bonding network together will carry some currents that attempt to equalise the potential differences between their ends, often known as 'ground loop' or 'earth loop' currents. The more they do not follow the route of the protective bonding conductors, the more current they will generally carry. Tradition (see 3.5) has been to avoid creating ground loops, but they are a benefit for EMC and solve problems that cannot be solved cost-effectively in any other way. Ground loops can cause problems for poorly-designed electrical and electronic circuits, but where the design of the electrical/electronic equipment is poor

the resulting problems can easily be solved at low cost (see 5.8).

Shielding of cables for EMC (see 5.11) is of little benefit unless both send and return conductors are enclosed together within a single shield. The better the physical balance between the send and return current paths, and the better the electrical balance between the signals they carry, the better will be the electromagnetic performance of the cable (whether it is shielded or not). Transducer signals and modern datacommunications would suffer terribly from interference in many modern systems if it were not for the careful use of shielded twisted-pair cables, where the twisted-pair (but not the cable's shield) carries the send and return signals.

Coaxial cables are not preferred, for good EMC, because the return current uses the same conductor (the shield) as the noisy currents that the shield is trying to protect from. Triaxial types solve this problem.

Power cables also benefit from close proximity of send and return conductors. For a delta connected three-phases system this would just involve the three phases and a safety earth, but in a star-connected system it would involve all three phases plus their neutral and safety earth (five conductors). Where high currents make twisting impossible, see 4.5.

4.5 What to do when send and return conductors cannot be routed in close proximity

Some systems use their CBN as their return path for both power and signals, and this is common in land vehicles,

sea-going vessels and aircraft, which use their chassis/hull, etc. as their return path for historical reasons. However, this approach has dire consequences for EMC, and should never be used where there is any practical alternative. It seems that the land, sea and air craft industries continue to use this approach because of the legacy of components, equipment and systems that have all been designed to use it, and which they want to use in new designs to save cost and time.

But they must soon reach a point where the costs and delays of dealing with the resulting EMI outweigh the savings of continuing with the legacy systems. The best generally-effective solution where such CBN-return systems cannot be avoided is galvanic isolation, at least for signals, control and data communications; for instance using twisted-pair wiring with galvanic isolation transformers, or fibre-optics.

Very high-current conductors, such as the vertical feeders in a tall building, or the motor cables for a steel rolling mill or other high-power industrial process, suffer high mechanical stresses on their conductors if placed too close together (due to electromotive forces), and this could damage their insulation. So they cannot be twisted together, or even placed in close proximity.

Very high voltage air-insulated cables also have to be spaced apart by considerable distances to prevent flash-over between their conductors. And of course busbars cannot (easily) be twisted together!

In both the high-current and high-voltage cases – and whenever power send and return conductors do not follow virtually identical paths in close proximity (e.g. by

using twisted conductors) – high levels of electric and/or magnetic fields will be generated. These fields could upset the operation of nearby electronics.

For example, problems with image stability on cathode ray tube (CRT) type visual display units (VDUs) such as computer monitors and television screens are often caused by magnetic fields from nearby power cables or busbars where the send and return conductors are not twisted together.

So, where high-current or high-voltage conductors are separated, it is very important indeed to keep them well away from any sensitive electronics. The resulting electrical and/or magnetic fields are easily calculated (see [39]) and their frequencies are known, and these should be compared with the immunity specifications for all nearby equipment. The EM fields should also be checked against personnel exposure limits, to ensure that personnel and third parties are protected from possible health hazards (see 2.2.2).

Busbar systems benefit from using types that create a laminated 'stack' of busbars separated by solid insulation instead of air. The solid insulation achieves the same insulation as the air, but with very much smaller busbar spacings, hence significantly lower emissions of magnetic and electric fields. There are now several manufacturers of such laminated busbar systems, which are provided with all the necessary components for quickly connecting to their conductors.

4.6 Segregation of apparatus and their supplies

Separating (segregating) equipment and cables, to reduce the likelihood of the emissions from one interfering with another, is a good EMC engineering practice that helps ensure EM compatibility between items of equipment. Segregation techniques can be applied between items of equipment that are part of the same system or installation (to help control 'intra-system' interference), and between the items of equipment within a system or installation, and equipment that is outside the system or installation (to help control 'inter-system' interference).

Segregation is a very low-cost good EMC engineering practice – if performed early enough in a project – so it is important to discuss segregation with architects and electrical consultants as early as possible. Good segregation can cost nothing if done early enough, but it can cost a fortune to achieve when EMC problems are discovered during commissioning or operation.

Segregation places strong emitters and their cables as far away physically as can be practically achieved from sensitive/critical equipment and their cables, and supplies their mains power from separate phases. It is even better to supply their mains power from different HV distribution transformers. Cable segregation is dealt with in more detail in 4.8.

Suppliers' EMC installation and use instructions might include segregation requirements that go beyond what is described here or in 4.8, so it is always important to obtain all such EMC instructions (the new EMC Directive [1]

[8] [4] [9] makes it mandatory for suppliers to provide them), read them carefully, and fully implement their requirements.

Segregation is *absolutely essential* when EM mitigation techniques are used, such as galvanic isolation (see 4.3), filtering (see 5.10), shielding (see 5.11 and 5.12) or surge suppression (see 5.13) – and this technique is often called 'EM Zoning' (see 5.4). Without EM Zoning, any mitigation techniques will be ineffective, and therefore a waste of time and money.

Since we can never be quite sure that we will not have to add some filtering, shielding or surge suppression to solve an unexpected problem with an installation, it makes very good financial sense to always do very good EM Zoning (segregation) from the start of the design and construction of any vehicle, vessel, building or site, so that EM mitigation can be easily applied later, if problems arise.

Equipment should be classified as high-voltage (HV, > 33kVAC rms), medium voltage (MV, between 1 and 33kVAC rms) and low voltage (LV, < 1kVAC rms). LV equipment should then be classified at least as 'noisy' or 'sensitive', with more sub-categories used where even greater control of EMC is required.

Examples of noisy equipment include adjustable-speed (variable speed) motor drives; electric welding for metal or plastics; power rectifier systems for electrochemical processes; relays and contactors; radio, television, and radar transmitters; electrosurgery and medical diathermy; Group 2 ISM equipment according to CISPR11 [27]; switch-mode power or frequency conversion, and many kinds of scientific apparatus.

Examples of sensitive equipment include radio, television, and radar receivers, instrumentation for temperature, flow, weight, pH, humidity, pressure, and any other physical parameters; CRT type visual displays and photomultiplier tubes; audio induction loop systems; many types of medical devices; programmable electronic devices such

as computers and programmable logic controllers (PLCs). Many types of equipment now incorporate computer technology, making almost everything sensitive equipment.

Figure 12 shows an example of segregating the equipment on a large site fed at HV.

Figure 12 Example of segregating apparatus and their mains supplies

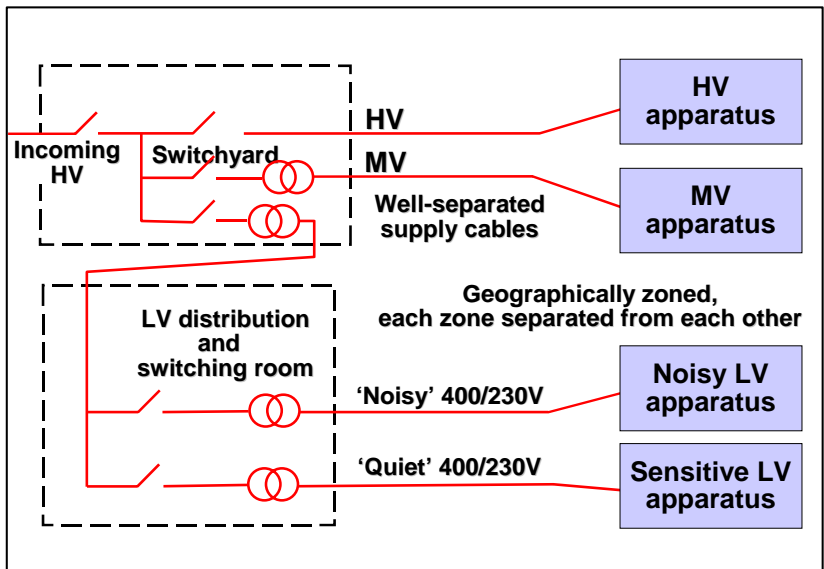

Figure 12 shows the different classifications of equipment being powered from different mains distribution networks which are routed separately from each other, with the two (or more) classifications of LV equipment ideally powered from different distribution transformers. The different classifications of apparatus should be spaced well apart from each other, the further the better (metres rather than centimetres), and any other cables

associated with each type should be routed well away from each other (see 4.8).

Where equipment cabinets contain both noisy and sensitive equipment, their manufacturers would be expected to achieve internal segregation so that one did not interfere with the other.

For example, if a fork-lift truck battery charging station and a computer or fileservers room were adjacent to each

other it is possible that the battery charging could interfere with any CRT displays and/or the operation of the computer system. At the initial design stage it is easy to allocate these facilities to well-separated locations, and costs nothing to do. If interference problems are discovered during commissioning (or afterwards) the very significant costs of moving one of the facilities and its cabling well away from the other are likely to be dwarfed by the lost production due to the delays incurred.

Similar problems can arise in the food industry, where (sensitive) checkweighers and metal detectors are followed closely by packaging machines employing (noisy) RF plastic welding techniques for sealing plastic bags or cartons (Group 2 ISM [27]). If not designed-in from the beginning, the distance required between the packaging machine and the other equipment may not be achievable without wholesale re-structuring of the production line, at great cost.

4.7 The Bonding Ring Conductor (BRC)

Overvoltage surges caused by nearby lightning activity (i.e. within 3 miles, 5km) can enter an installation via any conductor, and are a major cause of equipment damage and downtime costing the global economy billions every year. To help protect against interference and damage, a Bonding Ring Conductor (BRC) should surround an installation. In fact, a separate BRC should surround each segregated zone or area within an installation, as shown in Figure 13. Some other terms that used for BRCs are 'earthing bus

conductor' and 'interior ring bonding bus'.

The BRC should be a copper conductor with a cross-sectional area of *at least* 50 sq. mm, for example a round conductor with at least 8mm diameter, or 'lightning tape' at least 25mm x 2mm. For more details on the purpose, design and construction of BRCs see [50] [51] [52] [53] and [32].

Also as shown in Figure 13, *all* conductors and conductive services (e.g. metal pipes or ducts for gas, water, air, etc.) entering a segregated area should be RF-bonded (see 5.7) to the appropriate BRC, either directly, or indirectly through filters and/or surge protection devices (SPDs), *at the point where they cross the BRC*.

There are no exceptions to this rule, which applies throughout this Guide, even for 'earth' or 'ground' wires.

It is best to bring all of the services into the area in one place, and make all of the RF-bonds to a small part of the BRC – its main bonding bar. Since the BRC is almost always also used as the method of providing protective (safety) earthing to equipment, this bonding bar is usually called the 'main earthing bar'. As Figure 12 shows, this bonding bar is connected to the BRC at each end – it is actually a section of the BRC.

When RF-bonding filters or surge arrestors to the BRC, it is generally best to expand the dimensions of the bonding bar to make it a large enough plate for them to be mounted on. This 'bonding plate' technique is described in 5.7.

Ordinary water is conductive, and wastewater can be especially so. The author knows of one large chemical processing plant where about 100kA of

current was 'lost', eventually discovered flowing in the wastewater stream. Where a conductive liquid in a plastic pipe is flowing into or out of a zone or area surrounded by a BRC, it might be necessary to insert a metal pipe section (say, at least 2m long) at the point where the service crosses the BRC, and RF-bond the metal pipe section to the BRC at the bonding bar.

It might be possible to replace some metal objects providing mechanical functions, such as pull-cords or push-rods, and metal pipes for pneumatic or hydraulic power, with ceramic or plastic alternatives, to avoid the need to RF-bond them as they cross the BRC.

When adding a BRC to an existing (legacy) installation it is often inconvenient to move all the cables and other services so they enter the segregated area close to its main earthing terminal. They should be bonded (directly, or via surge suppressers and/or filters) to the BRC where they cross it. But this is not ideal and the cable or service may need to be re-routed close to the main bonding terminal if problems arise.

Of course, replacing analogue and digital cables with (metal free) fibre-optic cables, free-space lasers or microwaves, avoids the need to bond anything to the BRC as they cross it.

Figure 13 An example of using BRCs in a segregated installation

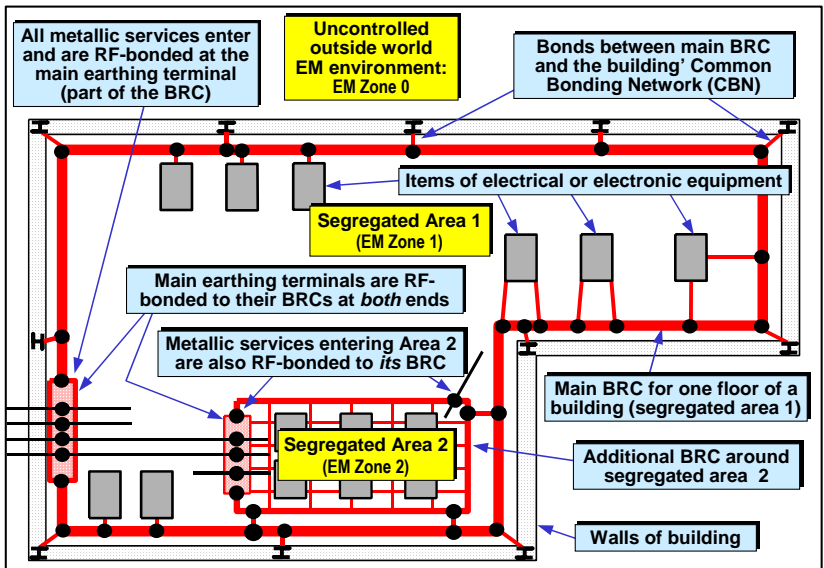

Where items of equipment are close to a BRC, their frames, chassis or metal

enclosures should be bonded to it with conductors of at least 28 sq. mm that are

up to 2 metre in length. Where they are further from the BRC than this, two bonding conductors should be used, spaced as far apart as possible. Where such cables would exceed 4 metres in length, the BRC should be 'meshed' by adding additional 50 sq. mm conductors that bond to the BRC at both ends and cross the segregated area in such a way as to allow those items of equipment to bond to it with short conductors.

Note that the bonds from the equipment to their BRC are not safety earths – they are *additional* to the protective earthing conductors in the mains supply cables to the equipment, they do not replace them. (In some circumstances it might be possible to replace the protective earthing conductors in the mains supply cables with bonds to the BRC, but this depends on the relevant safety standards and is outside the scope of this Guide.)

Of course the BRC and its equipment bonds create 'ground loops', but the general hysteria about avoiding ground loops is misplaced, in fact using many small ground loops is an essential tool in EM mitigation (see 5.6). Since the bonds only connect to the equipment's metal frames, chassis or enclosures, the so-called 'ground loop' currents will not flow through the electronic circuits of equipment that has been correctly designed (using good EMC engineering techniques that have been well-established for over 20 years, so will not cause interference).

But if in any doubt about the quality of the electronic design in the equipment, make the equipment's bond to the BRC to the same piece of metal that the equipment's "Protective Earthing Terminal" is fixed to, and as close to that

terminal as practical, so the ground loop currents do not flow around the its metal structure.

In fact the resulting ground loops will reduce the impedance of the ground structure and hence reduce the noise voltage differences between items of equipment, which will help reduce the electrical noise levels in their signal interconnections and be good for reliability and EMC. This is discussed in some detail and demonstrated by experiments in [54], from the point of view of professional audio applications, and [55] and [56] are also relevant.

This issue often arises in professional audio installations because of the very high signal-to-noise ratios they require. It is also common in information technology systems and installations because of the very high frequency signals they send down their cables, but in fact it is relevant for all types of installations.

Connecting filters and/or SPDs to a BRC is made easier if they are mounted on the backplate of an industrial cabinet, using DIN-rail mountings for example, and making the backplate a part of the BRC's 'ring' circuit. A metal plate used for this purpose is effectively an bonding bar, but sometimes called a 'transient suppression plate' or a 'filter bonding plate' – depending on the types of components mounted upon it. Good EMC engineering practices concerning filters are discussed in 5.10, and for SPDs see 5.13.

The BRC concept should be very familiar to those who work in industries that have to deal with explosive atmospheres. Each hazardous zone in such installations must be surrounded by a very heavy-duty BRC, and all

explosion-proof cabinets have fixing points on each side for connection to the cut ends of the BRC, so that they become part of the BRC. Every metallic cable or service entering a hazardous zone must be RF-bonded to that zone's BRC (see 5.7).

In Section 5 the BRC is developed into an integral part of a metal mesh structure that provides more attenuation at higher frequencies for protection against lightning and other EM threats entering via conduction, induction or radiation.

4.8 Cable classification, routing and segregation

4.8.1 Cable classification techniques

Note that some of the techniques described in this section might not be compatible with 'single-point earthing' (see 3.5). Solutions are provided at the end of 5.8.

LV cables (< 1kVAC rms) are split into at least four classes, and each class run along a different route, only bundled with (or in close proximity to) cables from its own class. Ideally, cable classes would not cross over each other, but where they must cross they should do so at right angles (and even then some additional metal shielding, see 5.11 and 5.12, may be required between classes more than one class apart).

[43] describes a system that uses five classes, where the middle class is called "EMC indifferent". The author finds it hard to imagine any cables that are truly indifferent to EMC, so this class is not used in the system described below (but the 'ghost of the middle class' (!)

appears in the segregation distances proposed later on).

Class 1a cables – for sensitive analogue signals

This class includes all low-level analogue signals (e.g. thermocouples, thermistors, resistance thermometers, strain gauges, load cells, microphones, receiving antennas, encoders, tachogenerators, etc.) including all analogue signals with a full-scale value less than 1 volt or 1mA; a voltage signal with a source impedance greater than 1k Ω ; or where the signal-to-noise ratio is required to be greater than 72dB (or to be digitised with a noise level smaller than the LSB in a 12-bit system).

This class must use good quality twisted pair cables with shielded connectors, with no breaks in their shielding anywhere – often called 360° shielding (see 5.11) to achieve a high level of shielding effectiveness up to the highest frequency that needs to be controlled.

Class 1b cables – for sensitive digital signals

This class includes all high-rate serial digital communications e.g. Ethernet, USB, Firewire, LVDS, video, etc. Good quality shielded twisted-pair (STP) cables with good quality shielded connectors at both ends are generally recommended, see 5.11.

Class 2 cables – for slightly sensitive signals or power

This includes all 'ordinary' analogue signals, for example 4-20mA, or 0-10V with a source impedance of under 1k Ω , signal-to-noise ratios of

less than 60dB or digitisation to less than 10 bits. It also includes low-rate digital bus communications based on 5 volt powered logic devices, such as RS232, RS422, RS485, etc.

These should use shielded cables, but the shielding effectiveness requirements are not as severe as for Class 1 cables. Flat ribbon cables must either be fitted with flat shielding jackets or (preferably) shielded 'round and flat' (where a flat cable is rolled up and sheathed in an ordinary cylindrical shield. Flat ribbon cables should use the send/return configurations shown in Figure 11 for both signals and power.

This class also includes AC or DC power (up to 230/415V) that has been internally filtered to a high specification (see 5.10) in an equipment cabinet – providing whatever equipment is powered by this Class 2 cable is not also connected to any Class 3 or 4 cables from any other equipment. These power supply cables should twist their +V and –V conductors, or their phase, neutral and safety earth conductors together, but can generally use unshielded cables.

Digital (i.e. on/off signals, not data) inputs and outputs (e.g. limit switches, non-data-bus low rate signals) can use shielded or unshielded cables, or single send and return wires in a bundle. Twisted pairs are always preferred in both shielded and unshielded cables, and any flat cables should use one of the schemes shown in Figure 11 and described in 4.4.

Class 3 cables — for slightly interfering signals or power

This class is for LV (up to 230/415V rms or 600V peak or DC) power typical of the mains supply in a typical residential building, office or other commercial building, and most light industrial units. Such mains supplies will not be connected to 'noisy' equipment such as electric arc welders, Group 2 ISM equipment according to [27], or high-power variable-speed motor drives or switch-mode power converters or uninterruptible power supplies. All the electronic equipment connected to such mains supplies with emissions broadly in line with the generic emission standards IEC/EN 61000-6-3 or 61000-6-4, whichever is the most relevant for their EM environment, or standards with equivalent limits on emissions.

It should be noted that the EMC product standards listed under the EMC Directive for arc welders, Group 2 ISM and high-power power converters (e.g. IEC 61800-3 for motor drives; IEC/EN 60974-10 for arc welding; EN 12015 for lifts, escalators and moving walkways; [27] for ISM, etc.) can allow higher levels of emissions than would be appropriate for a Class 3 cable, see Class 4.

These power cables should always use shielded or unshielded cables or cable bundles that include all +V and –V conductors, or phase, neutral and safety earth conductors, preferably twisted together.

This class also includes control circuits with resistive and inductive loads (e.g. the coils of solenoids,

relays and contactors). They should always be fitted with the transient suppressors recommended by their manufacturers. They can use shielded or unshielded cables, twisted pairs, or single wires in bundles as long as the sends always have closely routed return conductors (twisted pairs are always preferred, whether cables are shielded or not).

AC motor cables are also Class 3 *providing* they are 'direct-on-line (DOL) on/off controlled and the AC supply used is itself Class 3, or else are powered by AC inverter drives fitted with appropriate mains filters on their power inputs. The output cables of these drives must either be very well shielded, or fitted with 'sinus plus' output filters that filter both the DM *and* CM signals so that the Pulse Width Modulated (PWM) signals are converted into reasonably pure sine-waves with very low RF content. These drives should always use cables that twist all the phases, neutral and safety earth together.

The contacts of manual switches, relays, contactors, thermostats and the like are connected directly to AC mains supplies, and when they switch they create high levels of 'fast transient bursts'. If the contacts are closer than about 10 metres to equipment, their frequency spectrum exceeds that assumed by the generic immunity standards. Nearby lightning events can cause surges that can exceed $\pm 6\text{kV}$ on single-phase supplies, and more than $\pm 12\text{kV}$ on dedicated three-phase supplies.

The generic immunity test standards IEC/EN 61000-6-1 and 61000-6-2

assume typical levels, frequency ranges and rates of occurrence for this type of noise, and it is often assumed that as long as none of the electromechanical contacts switch more often than 5 times per minute and create arcs that last less than 20ms, and the lightning exposure is typical of countries like the UK, the mains cables can be considered to be Class 3.

However, to better co-ordinate with the tests applied by the generic immunity standards, electromechanical contacts closer than 10 metres should all be suppressed using 'snubbers' recommended by their manufacturers, and surge protection devices should be fitted to the mains supply to limit its surges to $\pm 2\text{kV}$ peak (see 5.13).

Without such protection measures it is recommended to create a new Class 3b, – noisier than Class 3 (which would then be called 3a) – and only connect equipment to Class 3b if it is proven to be able to withstand such high transient and surge noise levels without errors, malfunction, or damage.

Note that Class 3 assumes that there is a vanishingly small likelihood of a direct lightning strike to the building in which the system or installation is installed, or else that it is acceptable for such events to cause errors or malfunctions, or actual damage, to any/all of the electronic equipment connected to it. Such assumptions are no longer generally acceptable, see 5.13.

Class 4 cables – for *strongly interfering signals or power*

This class is for any power cables (inputs or outputs) associated with electromagnetically ‘noisy’ equipment such as adjustable (variable) speed motor drives (DC, AC, stepper, etc.), electrical arc welding, Group 2 ISM [27], etc. These should all use braid shielded power cables (at least), and motor drive manufacturers often specify special cables, routing, or other suppressers, such as ferrite toroids or clips.

(Where AC ‘inverter’ drives are fitted with appropriate mains filters on their power inputs, and their output cables are either very well-shielded or fitted with ‘sinus plus’ output filters, it is possible for them to be Class 3 instead.)

This class also includes cables to RF transmitting antennas (type and termination always specified completely by manufacturer). It also includes control cables to unsuppressed inductive loads (relays, contactors, solenoids, etc.) using shielded or unshielded cables containing all the sends with their returns (twisted pairs preferred).

Cables to on/off controlled DC motors or sliprings are Class 4 and should use braid-shielded cables (send/return conductors twisted together) with their braid correctly RF-terminated at *both* ends (at the drive *and* the motor frame). Cables associated with ‘pancake’ DC motors, or DC motors fitted with spark-suppressed rotors or appropriate filters, might be able to be treated as Class 3.

Class 4 also includes AC or DC supply conductors connected to unsuppressed electromechanical contacts that can switch significantly more often than 5 times each minute (especially where they are closer than 10 metres to an equipment); where their switching arcs experience restriking; where high rates of nearby lightning events or direct strikes to the building are expected; or where the supply cables are connected to significant amounts of reactive stored energy that can be switched (e.g. AC or DC motors rated at more than 50kW, switched power factor correction capacitors, tap-changing transformers).

None of the IEC product or generic immunity standards test equipment with the levels that can exist on Class 4 cables – although the proposed IEC 61000-6-5 (generic immunity standard for power generation installations) might come close for some of the EM phenomena. So without special mitigation measures (e.g. filtering and surge suppression) having been taken, it should be assumed that ‘ordinary’ CE-marked electronic equipment attached to Class 4 AC or DC supplies will suffer from errors and malfunctions, and could even suffer permanent damage quite quickly.

Whatever the classification of the cable according to the above, always check whether equipment suppliers or relevant industry standards (e.g. [57]) recommend special types or grades of cables, special connectors, routing, shield termination methods, or other techniques to control EMI. Many industry

codes or standards, and some international standards published by standards bodies (e.g. [57]) specify the types of connectors to be used, and sometimes cable types too, for certain applications (e.g. 100base-T Ethernet). Unfortunately, many of them have not taken EMI issues into account.

Problems arise when an industry standard cable interconnection (e.g. phono, jack, Ethernet, USB, Firewire, etc.) is based solely on providing low-cost and adequate functionality and so suffers from EMI problems. Their connectors often appear not to have been designed with good EMC performance in mind, so they do not provide very effective RF terminations for their cable shields required to control the EMI. [57] seems to have been developed assuming the 'normal' EM environments as expressed in the generic EMC standards in the IEC 61000-6 series, but see [37] for some of the shortcomings in these standards as descriptions of the real-life EM environments.

Any bundles containing untwisted send/return conductors should include at least one additional conductor bonded to the equipment frames or chassis or metal enclosures at both ends, see Figure 11 and its associated text in 4.4. Any cable armour should be RF-bonded to the equipment frames, chassis or metal enclosures at *both* ends, and RF-bonded at all joints along their length. See 5.8 for why the resulting ground loops are a benefit for EMC and with a little attention should cause only benefits, not problems.

In fact, adding one or more 'chassis bonding' conductors to any bundle of wires or cables is a useful EMC

technique, whatever the styles of cables used in the bundle (individual, twisted and/or shielded).

Where a powerful RF transmitter is nearby, all cables of whatever class may need to be shielded types and use shielded connectors (depends on the transmitter's power, frequency and proximity), see 5.11.

In addition to the above four classifications, if MV (1-33kV) or HV (> 33kV) supply distribution cables are nearby, we might call these Class 5 and Class 6 respectively. Air-insulated high-power busbars and high-voltage distribution cannot easily be shielded, so the other cable classes in proximity to these may need to be protected by additional shielding, or by very much greater segregation (see 4.6).

Cable armour should also be used as a shield, but its effective use demands reliable 360° electrical bonding methods at all joints and terminations (see 5.7). But most types of armour do not provide a very good or reliable shield for RF – although there are some types of armour specifically designed to provide RF shielding as well as mechanical protection.

4.8.2 Cable segregation and routing techniques

All cables between items of equipment should follow the same route whilst maintaining at least the minimum separation (segregation) between the bundles of cables in each Class. Only cables of the same Classification may touch each other or be bundled together. Where cable classes must cross each other, they should only do so at right

angles, and even then their insulation should not touch.

Figure 14 shows the recommended *minimum* spacings between cable classes, based on a parallel run of cables up to 30 metres long, routed close to metal supports that form part of the CBN at all times. Longer parallel runs should use pro-rata greater spacings (e.g. double the minimum distances for a 60 metre run).

Figure 14 exhibits the ghostly remnant of the “indifferent” cable class used in BS IEC 61000-5-2, as the 300mm spacing between its Classes 2 and 3. If this indifferent class was used it would be in the centre of this region, with 150mm spacings either side to Classes 2 and 3.

The metal ducts, trays, or other support structures that are part of the CBN should only contain as many Classes of cables as do not compromise the minimum spacings in Figure 14.

Figure 14 Minimum segregation distances between cable classes (in mm, not to scale)

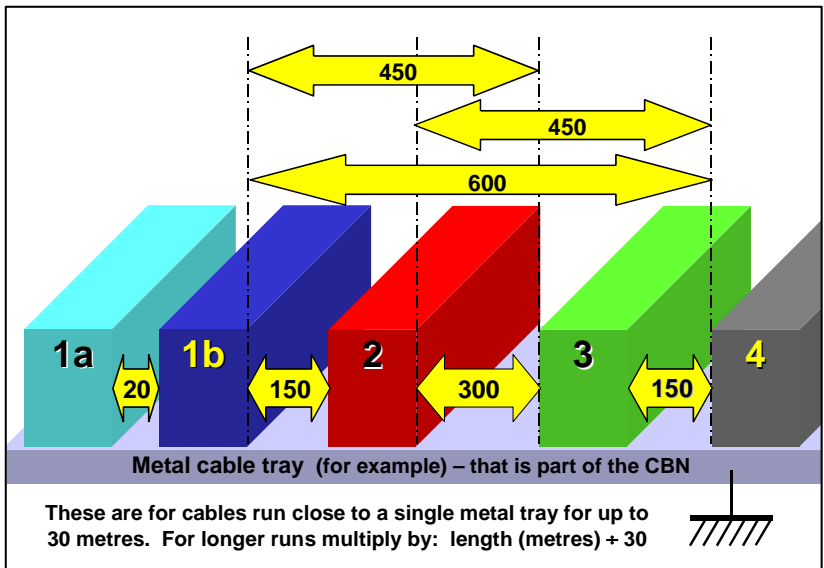

The spacings between Classes may be reduced if cables use higher quality shielding along their route (e.g. double-shielded cables, see 5.11) and/or if filtering is added (or improved) at both ends of the cables (see 5.10). They may also be able to be reduced if metal

dividers are used between Classes, the dividers RF-bonded (see 5.7) metal-to-metal to the duct or tray at least every $30/f_{\max}$ metres at the highest frequency to be controlled, along its entire length (f_{\max} in MHz).

But general guidance on such reduced spacings is not available other than to say that – where each Class is contained in a dedicated solid metal conduit – the spacings between them can be ignored. A covered metal duct can be as good as a solid conduit, if the cover makes a reliable direct metal-to-metal contact to both of the duct's sides at least every $30/f_{\max}$ along its entire length.

For a metal tray, duct, conduit or other metal structure to be part of the CBN and suitable for cable routing as shown in Figure 14, it must be RF-bonded as described in 5.7 to the equipment's metal chassis/frame/enclosure at both ends, and RF-bonded at every joint along its length and to any other members of the CBN that are appropriate. ('Earthing' a section of metal cable support with a single green/yellow wire connected to an 'earthing' point somewhere actually *worsens* EM performance instead of improving it, by increasing the crosstalk between the cables.)

Unshielded multiway cables, or bundles of unshielded conductors, should include at least one conductor connected to the equipment frames (or chassis or enclosures) at *both ends*, in parallel with the cable Class's metal support structure (where there is one). The cable metal support structure must be rated to safely carry the maximum fault current that could occur in it. If there is no metal cable support, the additional 'frame-bonding' conductors must be so rated.

Classes 5 and 6 should have spacings beyond Class 4 depending on their insulation requirements but certainly not less than 150mm each. Where Class 5 or 6 cables are routed closer than 1

metre to Class 1 cables, the earthed duct or tray carrying the Class 1 cable should be fitted with a metal cover that makes frequent electrical bonds to the body of the duct or cover, at least every $30/f_{\max}$ and preferably closer, along its length. Solid metal conduit would be ideal for the Class 1 cables in this situation.

There is actually very little evidence for the minimum cable spacings recommended above – they really depend entirely upon the emissions and immunity characteristics of the equipment they interconnect, and the signal-to-noise ratios that can be permitted (which in turn depend upon the individual application). Some electronic equipment is so sensitive that these spacings might need to be increased or extra shielding or filtering applied. However, segregation distances *at least as large* as those shown in Figure 14 are generally recommended (greater distances are even better), because they seem to work quite well in the majority of installations.

Where cables are not routed close to a metal area (such as the cable tray of Figure 14) that is part of the CBN, the minimum spacings to other classes of cables should be increased considerably. Unfortunately, no guidance is available, and each case should be analysed mathematically, or with computer simulators, or by trail and error on an actual site.

There are standards for certain types of cable installations, for example structured wiring for Ethernet [57], which recommend different segregation distances and other installation practices. Where these claim to cover EMC issues they might perhaps provide

better guidance than this section does, but where they specify minimum spacings less than those in Figure 14, this Guide recommends caution.

Figure 15 sketches a plan view of part of an installation, with the cables

segregated by class but all routed along the same metal support structure forming part of the CBN, so as not to create loops.

Figure 15 Routing cables along the same path whilst maintaining segregation by Class

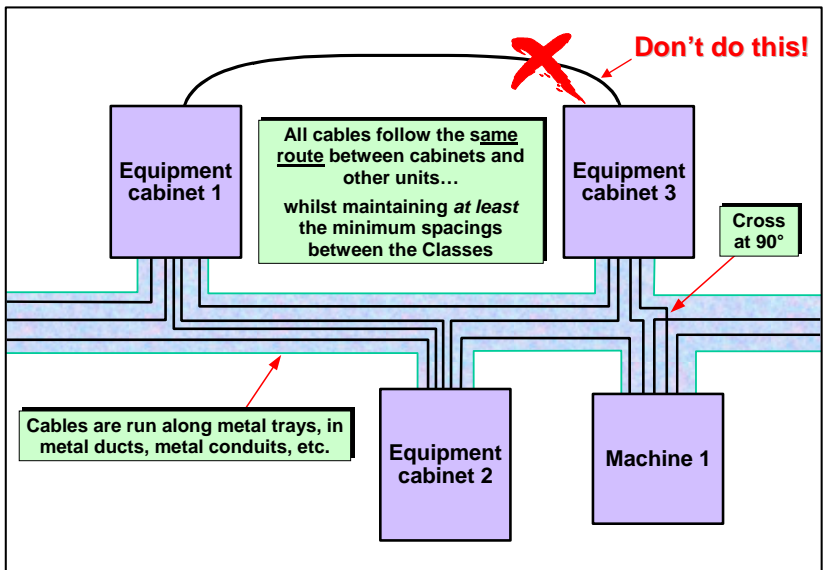
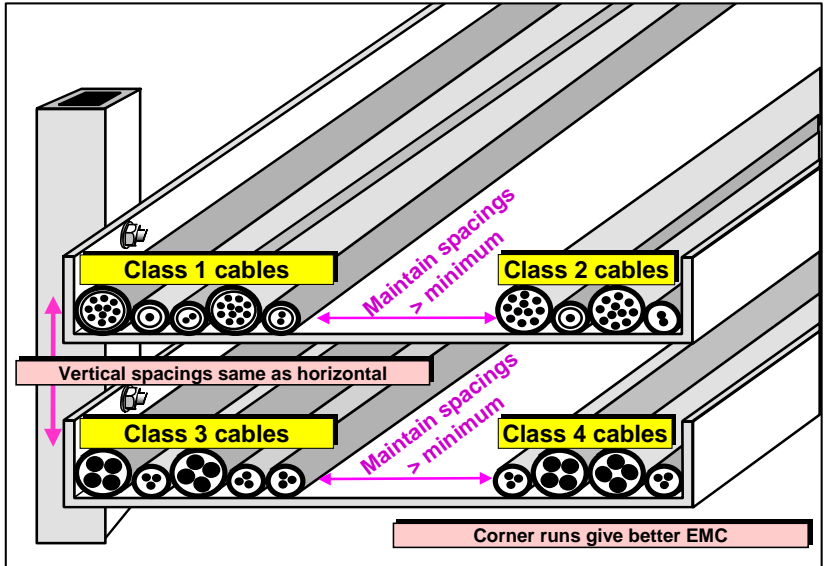

Figure 16 sketches a different view of the routing shown in Figure 15; showing how cable Classes may be split between two (or more) vertically stacked trays or ducts. The vertical spacings between two Classes in open trays or ducts should be *at least* as much as the horizontal spacings from Figure 14.

Internal corner runs in an earthed metal tray or duct are better at controlling higher-frequency EM fields, so should be reserved for the especially sensitive or noisy cables in each class.

If each item of equipment has a single connection panel, with the connectors segregated by Class, this helps achieve the above good EMC engineering practices described above. This also helps reduce the emissions from the equipment, and improve their immunity, as discussed in section 4.8 of [36]. Cables that enter or leave a cabinet on different sides, or top and bottom, are not recommended.

Figure 16 Example of segregating cable Classes in stacked trays



4.8.3 Cable segregation and routing in single-point earthed installations

Techniques described in 4.8.2 include the use of conductors and metal structures that are part of the CBN, that directly connect between the metal chassis/frames/enclosures of the items of equipment interconnected by the cables. This is in fact a CBN-meshing technique that is described in more detail in 5.5. But of course it creates 'ground loops' and so is not consistent with the rigorous use of the traditional single-point 'earthing' approach.

As described in 5.8, the single-point earthing approach has a very bad effect on the EMC characteristics of a system or installation, so is not generally recommended for any systems or installations these days, even legacy

sites. In fact, most of the systems and installations of any complexity and age that are proudly proclaimed to employ single-point earthing, generally do not – they often have one or more loops, sometimes hundreds (as in an air traffic control centre for a major UK airport that the author was asked to assess).

Because of the dogmatic adherence to the long-outdated idea of single-point earthing, it is common to see beautifully-constructed cable management systems with bundles of cables carefully routed along trays and in ducts and conduits – but those metal support structures are not electrically connected to the equipment the cables interconnect – or to each other (for example, where they cross). Instead, each of their sections has a green/yellow insulated wire that snakes off via a different route to the

main earthing terminal, where there might be a number of copper bars dedicated to the protective bonding of all such items of metal throughout the site.

Such metal support structures do nothing for EMC, and in fact they actually *increase* the noise coupling between cable classes – necessitating larger spacings between cable classes than would be needed if the cables were floating in the air or supported by a plastic or wooden structure.

The only way to use metal cable support structures to get the EMC benefits described in 4.8.2 and the spacings of Figure 14 in a single-point earthed system, is for all of the cable trays, ducts, conduit or other metal support structures to be made a continuous electrical connection from each item of equipment to the main earthing terminal. In effect, the metal cable supports are connected in parallel with the green/yellow protective conductor of each equipment's mains cable.

Then all the cables that interconnect two items of equipment, say from A to B, must route along their metal support structures from equipment A to the main earthing terminal, and then along a different set of support structures from the mains earthing terminal to equipment B. Without appropriate design, in most installations this approach would considerably increase the length and cost of the cables and their supports, and it can be physically difficult to achieve on complex industrial sites.

4.9 Cables that interconnect different buildings

Within buildings that have been protected as described in 5.13, surge

overvoltages will be limited to one or two kV depending on the details of the design and construction employed, and equipment that complies with the relevant immunity standards should operate reliably and without undue EMI.

However, lightning, and faults in MV and HV power distribution networks can inject huge voltages (e.g. 2MV) and/or huge currents (e.g. 10s of kA) into cables that interconnect buildings.

Signal, control, data and similar cables between buildings should never be used, and should be replaced by metal-free fibre-optics, free-space microwave or laser, or wireless communications as described in 4.3 – *unless* those buildings are part of a single EM Zone 1 or higher (see 5.4) that has been designed to comply with the direct lightning strike and other requirements of 5.13. Such cables will generally be routed inside a metal conduit or covered duct between the buildings that is a PEC (see 5.9) and also part of the MESH-CBN (see 5.5).

Likewise, mains power cables between buildings should never be used, *unless* they have been installed by the local power distribution authorities fully in accordance with their codes of practice, or a suitably-surge-rated isolating transformer is used where the power enters. In either case, the incoming supply to each building must be earth-bonded to its BRC, which in turn is bonded to its Lightning Protection System's (LPS's) earth electrode structure (see 5.13).

5.1 Introduction to EM mitigation

EM mitigation techniques rely upon developing the segregation techniques discussed in Section 4 above, to create what we call EM Zones. EM mitigation measures are applied at the boundary of each EM Zone, to control the EM disturbances that could enter or exit the zone. The boundary of an EM Zone can be thought of as a layer of protection, that:

- Protects equipment *within* the zone from EM disturbances originating *outside* the zone
- Protects equipment *outside* the zone from EM disturbances originating *inside* the zone
- Provides both of the above at the same time

Although we generally draw EM Zones as areas on a plan, and their boundaries as lines, we must never forget that the boundary of an EM Zone is really the surface of a three-dimensional volume, and any/all EM disturbances that could penetrate that surface by conduction, induction or radiation should be assessed and controlled where necessary to prevent EMI from occurring. EM Zoning is described in more detail in 5.4.

The EM mitigation measures that can be applied at the boundary of an EM Zone, to provide its layer of protection, include...

- **Power Distribution**, see 4.1
- **Power Quality** improvements, see 4.2

- **Galvanic isolation**, see 4.3
- **Grounding (earthing)** by creating an **RF Reference** that has a low-enough impedance at the frequencies to be controlled, see 4.7 and 5.5.

For a building, the RF Reference Plane is usually connected to one or more earth electrodes buried in the ground around its perimeter, and for a ship it is connected to the water in which it floats, but connections to such 'true earths' are not possible for some kinds of installations (e.g. land vehicles, aircraft, spacecraft, etc.). However, connection to a 'true earth' is not a necessity for EMC – it is the mesh-bonding of the Reference that is important.

- **RF-bonding** at joints, seams, and electrical bonds, see 5.7
- **Cabling**, see 4.4 and 4.8 for general techniques, 5.11 for shielded cables, and 5.9 for PECs.
- **Filtering**, see 5.10.

Filtering may be necessary for every conductor that enters/exits an EM Zone, which is not directly RF-bonded to the EM Zone's BRC, or shielded with its shield RF-bonded to the BRC as described in 5.7.6.

The word 'conductor' includes everything that could conduct – not just wires and cables.

- **Shielding** of EM Zones
Shielding can be achieved with a three-dimensional MESH-CBN, for example for lightning protection, and this is described in 5.5 and 5.12.

- **Surge protection**, see 5.13.

Surge protection may be necessary for every conductor that enters/exits an EM Zone, which is not directly RF-bonded to the zone's BRC, or shielded with its shield RF-bonded to the BRC as described in 5.7.6.

The word 'conductor' includes everything that could conduct – not just wires and cables.

5.2 Project management: depth of analysis, quality control, testing

The EMC mitigation measures described in Section 5, can be developed to create EM Zones with improved immunity and/or reduced emissions up to whatever level of performance is required, even to meet the toughest military or National Security requirements. Of course, the higher the level of EM performance required, the more detailed and accurate the design needs to be, and the more the construction should be supervised to ensure it results in the desired performance.

Most architects, electrical consultants, M&E contractors and installers have little/no idea about the use of good EMC engineering practices (see 2.3.9 and 2.4) – or may claim that they do but in fact are using methods (such as single-point bonding, see 3.5) that are worse than useless these days. So unless using service providers who have verified references regarding the quality of their EMC work (which will generally mean those who are used to building critical military and/or National Security facilities) every aspect of construction discussed in this Guide should be checked by EMC competent personnel

as it is done. This is especially important for features (e.g. rebar bonding) that will not be readily accessible later in the construction process.

The guidelines presented in this document are often quite crude. The EMC of a system or installation is an *immensely* complex issue, as a quick look at the formulas in [58] will show. The accuracy and detail of an EMC analysis can be improved by using formulas and calculations obtained from the various references provided, but in real life there are so many interactions in a system or installation that even these will not be close to predicting the final result of a construction.

Critical facilities (such as hospital life-support wards, operating theatres, data centres for the internet and financial institutions, military, national security, etc.) should always have their EM performance validated against their EMC specification by EMC testing after construction is complete. Some owners or their main contractors will make verification EM testing a condition of payment anyway. It is possible to perform on-site (*in situ*) EMC tests using hired or purchased equipment and competent personnel, and a number of EMC test laboratories offer mobile testing services for this purpose [59]. 5.12.14 gives some suggestions on testing an EM Zone's shielding.

However, if EM performance falls short of specification, modifying the vessel, building or site to make it comply can be extremely time-consuming and costly operation. The normal way of reducing these risks is to overdesign/overspecify the EM performance by at least 20dB, and/or build in certain features that allow EM performance to be improved

(relatively) quickly and easily if testing the final construction proves that it is not as good as required.

However, these days there are a number of 'three-dimensional field solver' computer simulators available that deal with the complexity and produce much more accurate and reliable results than it is possible for a team of EMC expert mathematicians to ever achieve. Their use permits much more cost-effective control of financial, safety or EMC issues. A number of EMC consulting companies offer bureau services in this area, and there are also software packages that can be purchased for in-house use, but this Guide does not include any recommendations or references.

Even though computers are now so very powerful, EMC field solvers have to use a variety of simplifying assumptions if they are to produce a result with the required accuracy in a reasonable time – but the assumptions used depend on the problems to be solved, and choosing the correct assumptions requires skill.

So, the accuracy of a computer EMC simulator should *always be verified* by comparing its predictions against real-life EMC measurements (taken *after* the simulation), on systems and installations and structures that are similar to the one for which an analysis is required. Differences between simulation and real-life testing of up to $\pm 10\text{dB}$ indicate a very accurate simulation, partly because EMC testing itself is subject to a number of uncertainties.

Never rely on simulators for which such verification has not been done, or has only been done on different types of EMC problems, or when the verification

tests show errors exceeding $\pm 20\text{dB}$ (without an *understandable* reason).

Obviously, even when using a verified simulator, it is best to overdesign/overspecify by aiming for an EM performance specification that is at least 10dB higher than is really needed.

Taking into account the degrading effects of ageing and foreseeable use/misuse, to help ensure adequate EM performance is maintained over the operational lifetime of the system or installation, perhaps the EM overspecification for the new construction should be at least 20dB higher than is really needed. Of course, the degree of overspecification for the new construction depends on how well issues like misuse, wear, corrosion, etc. will be managed and controlled over the operational lifetime, see Section 8.

Another issue with computer simulators is that they must be supplied with good quality data on:

- Material characteristics (e.g. the diameters, conductivity and permeability of rebars, when using them in a MESH-CBN and/or shield; surface transfer impedance of cable shields, etc.).
- Device characteristics (e.g. voltage/current/time characteristics of surge protection devices; attenuation/frequency characteristics of filters, etc.)
- Construction characteristics (e.g. mesh dimensions, RF-bonding details, etc.)
- Etc...

If the data they are supplied with does not match the final construction, the simulation results will not be accurate.

5.3 Supplier-specified EMC mitigation measures

Some of these mitigation measures may be required by the EMC installation instructions provided by suppliers of equipment or systems. It is good EMC engineering practice to follow such supplier instructions, where they are in fact consistent with good EMC engineering.

Unfortunately, some suppliers are working to outdated installation concepts (e.g. single-point earthing/grounding, see 3.5), and instructions supplied with some equipment might be incompatible with the instructions supplied with equipment that it is to be connected to. So there is always a need for competent assessment of whatever is done as regards EMC, rather than uncritically following supplier's EMC instructions.

Where a supplier's EMC assembly/installation instructions are not followed, compliance with 2004/108/EC would require appropriate documentation justifying this fact (see 2.3.10), and arguing why its requirement to employ good EMC engineering was in fact best served by what was done instead.

5.4 EM Zoning

These mitigation guidelines are intended to cost-effectively protect 'ordinary' equipment. But it is always possible to design equipment that is sufficiently 'EMC hardened' that it can be used anywhere, with or without shielding, and with or without an RF Reference. It is even possible to harden equipment so that it can be located outside a lightning protection system, and yet survive a direct lightning strike. Such hardening

comes at a price, but in some situations it can be the most cost-effective solution.

Where the necessary EM characteristics of a system or installation can be achieved solely by the appropriate choice of equipment and the good practice installation techniques in Section 4 above, then the system or installation does not need to employ the EM of the mitigation methods discussed in Section 5.

But modern systems and installations are becoming so complex, and employ such large quantities of advanced electronic technologies (especially digital, switch-mode and wireless), that they increasingly need to apply EM mitigation techniques so that they are reliable enough in operation, and don't cause their neighbours to complain of interference (see Sections 1 and 2).

EM mitigation techniques in systems and installations are always applied using an 'EM Zoning' approach, which is a development of the segregation approach described in 4.6. EM mitigation measures such as filtering, shielding, surge suppression, galvanic isolation, etc., are applied around the boundaries of each EM Zone, to attenuate the conducted, induced and radiated EM disturbances that would otherwise cross that boundary, as shown in Figure 17.

EM Zones are generally drawn in plan view, but we must not forget they are actually three-dimensional volumes, not areas.

The thick red line around each EM Zone indicates the boundary at which EM mitigation techniques are applied, and it follows the same path as the BRC discussed in 4.7.

Figure 17 Example of EM Zoning in an installation comprising six items of equipment

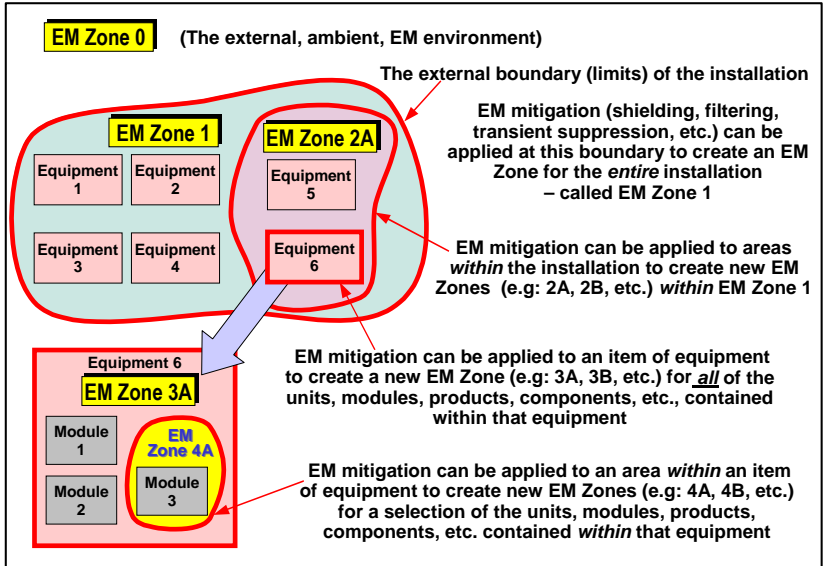

The uncontrolled external EM environment is always called EM Zone 0, and the volume contained within the site's BRC is always EM Zone 1. Within EM Zone 1 there could be many EM Zone 2's, labelled 2A, 2B, 2C, etc. Within the EM Zone 2's there could be many EM Zone 3's, labelled 3A, 3B, 3C, etc., and so on. Figure 17 shows four levels of zoning, with (in this example) EM Zone 3A being an item of equipment, and EM Zone 4A being a module within that equipment.

Where standard commercially available equipment does not have the EM specifications that are necessary for the reliability or compliance of the system or installation, there are two possibilities:

- Have custom equipment manufactured and tested to meet the EM specifications required by the installation.
- Create EM Zones employing mitigation measures around their boundaries, so that the combination of the attenuation provided by the mitigation plus the EM characteristics of the standard commercially available equipment meets the EM specifications required by the installation.

Figures 8 and 9 in 3.9 show how the selection of equipment is related to the EM environment and the mitigation techniques employed by any EM Zones created within an installation.

5.5 Conductive meshing

5.5.1 The MESH-CBN

To be able to control conducted and radiated EM disturbances at a boundary of an EM Zone requires a meshed (highly cross-bonded) CBN, generally known as a MESH-CBN, over that entire boundary – the entire layer of protection.

The mesh behaves as a shield that attenuates radiated EM phenomena, and it can also be used as an RF Reference Plane for equipment within that EM Zone. The problems of using a mesh as both shield and RF Reference are discussed in 5.5.3.

The BRC is an important part of the CBN's mesh, and filters, surge protection devices, galvanic isolation, and cable shield bonding are applied to any/all conductors at the point where they cross the BRC, as previously described in 4.7, to attenuate conducted EM phenomena.

Where the meshing has sufficient cross-sectional area, there may no longer be any need to have a BRC that is an identifiable single conductor. For example, the perfect MESH-CBN for EMC uses solid metal sheets instead of meshes, to create what is essentially a shielded room (see 5.12). In such a room, the BRC is any point on its sheet metal walls, floor or ceiling.

5.5.2 General mesh design and construction issues

To have any useful effect at up to the highest frequency to be controlled by the EM Zone boundary, f_{\max} , individual mesh elements in the boundary should have their largest diagonals or diameters, D

(in metres) much less than $50/f_{\max}$ (f_{\max} in MHz gives answers in metres). Even smaller mesh-element diagonals provide better EM characteristics.

Meshes with element diagonals of $150/f$ (or larger) provide no EMC benefits, and could even resonate and make their EM Zone's characteristics worse than having no EM Zoning at all. With $D = 50/f_{\max}$ the EM control achieved by the mesh at f_{\max} will not be *very good*, but at least it will not resonate.

Radiated EM pulses due to nearby lightning (lightning EM pulse, known as LEMP) are a threat to all electronics. To protect typical equipment from LEMP it is generally recommended that no part of the boundary between EM Zone 0 and 1 (e.g. the external walls, floor, ceiling or roof of a building) should have any mesh elements with D greater than 5 metres (see 5.13).

Especially sensitive or critical equipment may require greater attenuation of LEMP, so may need mesh diagonals smaller than 5m, and the design of meshes for such shielding is discussed in detail in 5.12.

Unlike a solid metal sheet shield (see 5.12.8) a mesh shield only achieves its full shielding effectiveness (SE) at a distance inside that is equal to its longest diagonal, D . Increased spacing is better, and especially-sensitive or critical cables or equipment should be spaced *much* further away, depending on the equipment's EM specifications and the severity of any interference consequences. The centre of a shielded EM Zone is the best location for sensitive and/or critical equipment and their cables.

Following the guidance in 5.12 for the SE of meshes for EM fields other than LEMP, seems like a good policy for EM fields of all types. But where the consequences of getting it wrong are unacceptable, a more detailed investigation of the SE provided by the meshed structures is recommended to achieve a satisfactory cost/risk balance. Planned structures can be computer-simulated using three-dimensional EM field solvers that have been validated (i.e. proven by experiment to be accurate) for this purpose, with the advantage that modifications can be made to the design before the construction materials are purchased.

For an existing building, or one that has been constructed following calculations or simulations of its SE, on-site measurements of SE can be done easily and quickly (see 5.12.14) using standard methodologies, either using hired test equipment or subcontracting an EMC test laboratory that offers such services. Where the consequences of getting it wrong are unacceptable, on-site measurements are always recommended, if only to check that the actual construction of a site has achieved its design intent.

Where such large spacings cause practical difficulties for locating equipment or cables, use a much smaller mesh size where the cables or equipment are located – ideally sheet metal. The smaller mesh or sheet metal should extend on all sides beyond the equipment or cables, by as far as is practicable – at least by D .

Where a maximum 5m mesh diagonal D cannot be achieved (e.g. due to very large doors, such as for an aircraft hanger), sensitive or critical equipment

and its cables should be located *at least* twice the value of D that was actually created, *away* from that mesh, to help avoid problems due to LEMP.

Better still, and especially where the consequences of getting it wrong are unacceptable, the equipment should be placed inside another EM Zone that provides useful shielding up to the highest frequency of concern. For example: if it was EM Zone 1 that had a $D > 5\text{m}$ due to a large door, then the additional LEMP protection should be provided by an EM Zone 2 (see Figure 17).

Where sheet metal is used as an EM Zone boundary, there is no D , hence no minimum spacing distance. However, any joints or seams between sheets that are not conductively bonded (e.g. seam-welded) *all along their length* – and any gaps or apertures in the sheets – should be treated exactly the same as a mesh with longest diagonal equal to D , with all the above ‘rules’ applied.

Meshed constructions create very many, very small ‘ground loops’, sometimes called ‘earth loops’. These are a *good thing* for EMC and not a cause for concern. See 3.5, and also 5.8 for more detail and some simple solutions for any problems caused by poorly-designed equipment.

All the various metal parts and other conductors that are meshed to create an EM Zone boundary, whether or not it is also used as an RF Reference, must be ‘RF-bonded’ together, using bonding techniques that reliably achieve low impedance at the highest frequency to be controlled, see 5.7.

5.5.3 Using a conductive mesh as an RF Reference

The concept of the RF Reference was introduced in 3.4, and within an EM Zone its MESH-CBN (or MESH-IBN) is used as its RF Reference, sometimes called its 'RF earth', 'RF ground' or 'RF common'). This is generally connected to the safety earthing system, if it is not the same conductive structure.

At frequencies above a few kHz, only a meshed (ideally a sheet) metal area or volume can achieve a reliable RF Reference that achieves a low impedance (typically $\ll 1\Omega$) at frequencies up to the highest to be controlled (f_{\max}).

(RF References are almost always 'earthed' or 'grounded' and can serve the dual purpose of providing electrical safety earthing or grounding functions for equipment, but such issues are not within the scope of this Guide and are not discussed further. Only the EM characteristics of the RF References are discussed here.)

Some very critical or sensitive installations will need to use sheet metal as their RF References, but most 'ordinary' installations will probably be able to use meshed metal structures instead.

For an RF Reference to be effective (as a low impedance RF 'earth' or 'ground') for its EM Zone, all of the cables and other power and signal conductors, and devices and circuits in unshielded plastic enclosures, should be *much* closer to it than $30/f_{\max}$ (f_{\max} in MHz gives the answer in metres), and $3/f_{\max}$ should be the target for general use (e.g. 30mm for an f_{\max} of 100MHz).

Also, electrical/electronic equipment using metal frames, chassis or enclosures, or shielded plastic enclosures, should have their frame, chassis, enclosure or shield bonded to the RF Reference with at least a 28 sq. mm copper conductor (e.g. 6mm diameter, although a braid strap would be better) that is *much* shorter than $30/f_{\max}$, and once again $3/f_{\max}$ should be the target for general use. RF-bonding techniques are discussed in 5.7. (Good EMC engineering practices should also be employed in the design and construction of all the equipment used, see [36] for industrial cabinets and the like that uses metal or shielded plastic enclosures.)

These $30/f_{\max}$ and $3/f_{\max}$ 'rules' only ensure that *some* EM benefits are obtained from the RF Reference, and closer spacing and much shorter bonding conductors will achieve improved EM characteristics. If $30/f_{\max}$ cannot be achieved, the RF Reference will not provide any significant EMC benefits, and consideration should be given to extending it to be much closer to the equipment or cable concerned.

Routing cables very close to an RF Reference – along their entire route – greatly reduces their accidental antenna effects (see 3.4), and the benefits are very much greater when the metal frames, chassis or enclosures of the equipment at both ends of the cables are also RF-bonded (see 5.7) to the mesh. So, closer proximity to the RF Reference also helps an EM Zone to control radiated disturbances.

As mentioned in 5.2, these f_{\max} based 'rules' are in fact only very crude guidelines, and radiated EM computer simulations using three-dimensional field

solvers working with real data are recommended to help design RF References for cost-effective control of financial, safety or EMC compliance risks.

5.5.2 said that where a mesh is used as an EMC shield, equipment and cables should be located at least D (the largest diagonal of the mesh's individual elements) away from the mesh, with further being better. But when using a mesh as an RF Reference, closer spacing is better.

This makes it impossible to use a mesh as both a shield for an EM Zone and as the RF Reference for the equipment within it. This situation does not arise with a sheet metal shield/RF Reference, but it needs to be addressed when relying on meshes.

In general, when using mesh-bonding techniques, the BRC for an EM Zone will be located along the line where its RF Reference intersects any shielding around the EM Zone. When using sheet metal shielding with adequate thickness (see 5.12.8), there may be no need for a separate BRC – the whole metal shield may be able to be used as a BRC.

When the RF Reference is the lowest floor in a building, as shown by Figure 18, and the soil attenuates the EM fields sufficiently, the floor mesh (RF Reference) does not have to provide shielding so there is no conflict.

[60] says that ordinary soils do not attenuate at a very high rate, at frequencies below 10MHz. If the soil does not provide sufficient attenuation to protect against external EM threats, a shielding layer should be added underneath the RF Reference floor, spaced below by at least the longest diagonals used for the shield's mesh elements. As mentioned earlier, if the RF Reference is a sheet metal construction, there is no conflict between its roles as shield and RF Reference.

Similar issues can arise where meshed floors within a building are required to act as shields between EM Zones on separate floors. If sheet metal is not used, there should be two meshes spaced apart by the D of the shielding mesh – one to provide the shielding and the other to act as the RF Reference.

Where meshes are achieved by welding rebars and/or other meshed material (see 5.12.4) inside a concrete floor or wall, and the individual mesh elements have a D that is equal to (or less than) half the thickness of the concrete, then the thickness of the concrete can provide all the spacing that is necessary – allowing equipment and/or cables and/or the RF Reference to be placed directly on the concrete surface containing the shielding mesh.

Figure 18 Example of meshes used as shields and RF References

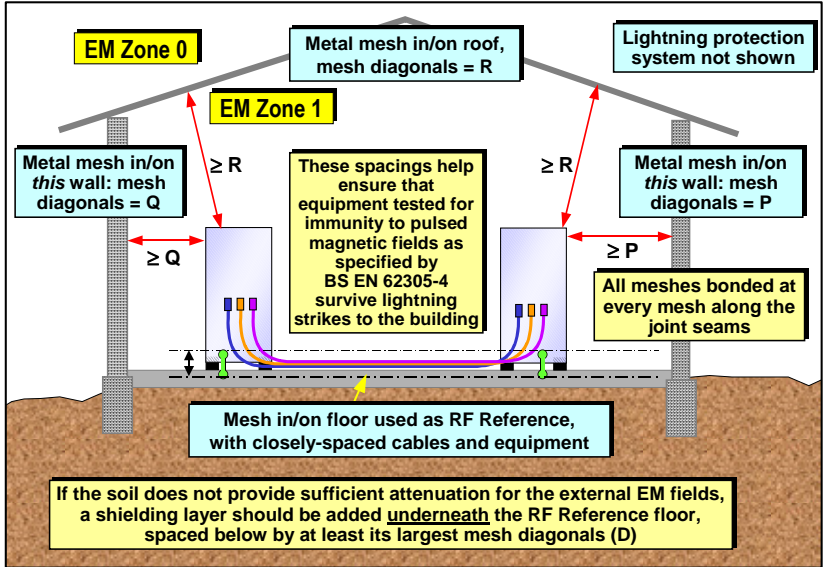

5.5.4 The 3-dimensional meshed common-bonding-network (MESH-CBN)

Figure 19 shows a very old style of earthing system using single-point bonding methods for two separate systems, each with their own earth electrodes, one for the 'power' or 'dirty' earth, the other for the 'clean' earth. The lightning protection system (LPS), if

present, had its own earth electrodes. This method is very dangerous and should never be used – during lightning strikes the voltages between the different earth systems can be 100s of kV, causing serious electrocution, fire and explosion hazards. Legacy structures should *immediately* be converted to Figure 20, or better still, Figure 21.

Figure 19 Independent earthing: not suitable for EMC and creates safety hazards

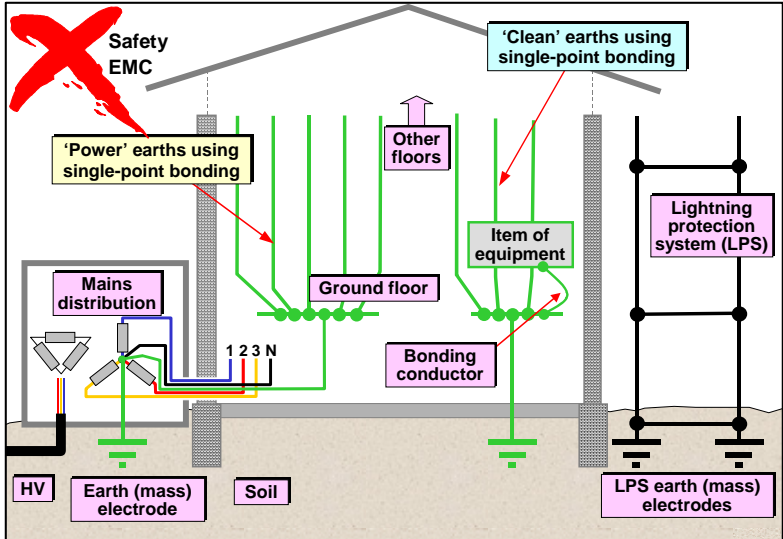

Figure 20 Single-point earthing: good for safety, but poor EMC at any frequency

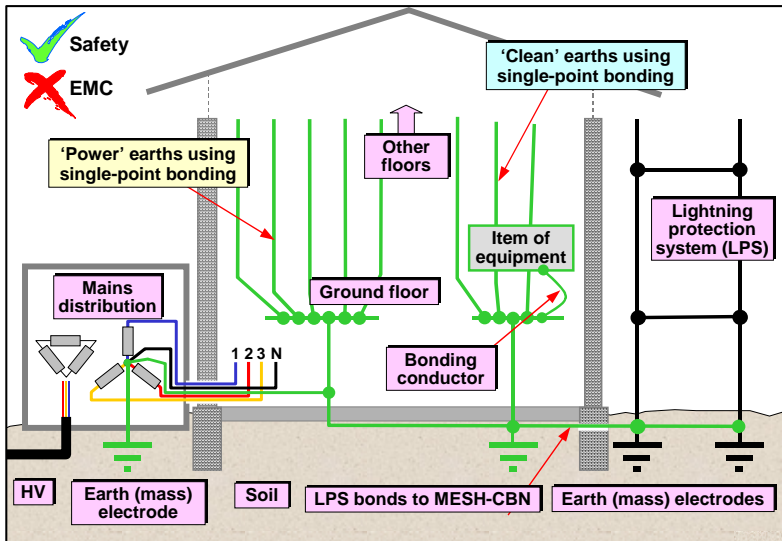

Figure 20 shows the earthing system that has been most common in recent decades. All the earth electrodes are connected together and then feed single-point bonded earthing systems as necessary, such as 'power' or 'dirty', 'clean' and a LPS if present. This is adequate for safety, but does not provide an RF Reference so is poor for control of EM disturbances above a few kHz, see 3.5 and 5.8.

It is still generally an adequate earthing structure for typical domestic and small commercial or industrial installations, where the density of electrical/electronic equipment and signal/control cabling is low. But it is not recommended where there is a high density of equipment and cabling, or where safety, financial,

political or other risks due to EMI are unacceptable.

Figure 21 sketches a meshed 'earthing' or 'grounding' structure that can be used as an RF Reference and/or shielding at the boundaries of an EM Zone. In IEC standards for electrical installations (e.g. [43]) it is often called a meshed common-bonding network: 'MESH-CBN'. This achieves low impedances from DC up to a frequency determined by the size of the mesh (see 5.5), and is a very important element of modern installations with concentrations of high-technology equipment including computers, radio/tele/ datacommunications, variable speed motor drives, and the like.

Figure 21 3-D MESH-CBN: excellent for safety, RF Reference depends on mesh dimensions

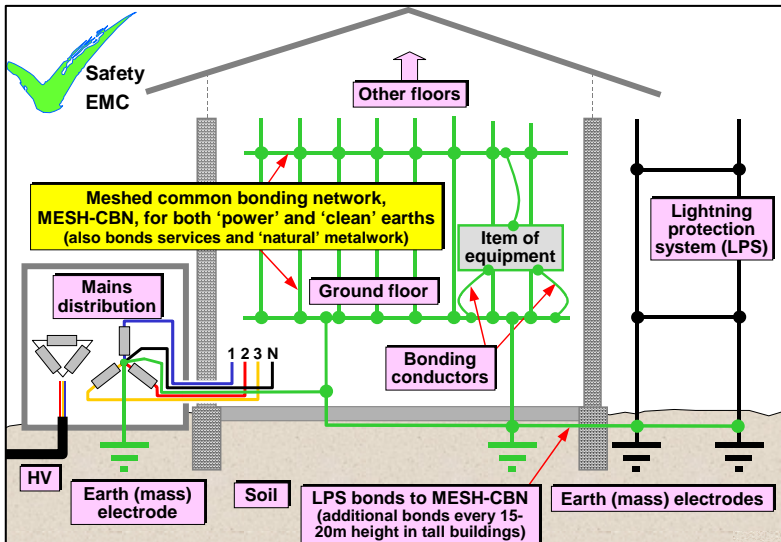

MESH-CBN techniques were first developed for data and telecommunication centres, but the density and sophistication of electronic equipment now used in many other types of installations means they are now more widely used. And, as described earlier, without a conductive mesh in the boundary of an EM Zone, the EM mitigation techniques employed at the boundaries will not be effective. Some of the standards and other documents recommending the use of MESH-CBNs and providing design and construction details include: [2] [32] [43] [50] [51] [52] [53] [61] and [47], provide more information.

The boundary between EM Zone 0 and EM Zone 1 (see Figure 17) requires a three dimensional (3-D) MESH-CBN volume, one surface of which (usually the floor) is generally used as the RF Reference (but see 5.5.3 and Figure 18). Where internal EM Zones (e.g. Zone 2 or higher) only need to control conducted EM disturbances, they only need to use a meshed area, such as a floor or wall, as their RF Reference and they may not require a meshed volume.

However, to control induced and radiated EM disturbances at an EM Zone boundary always requires a 3-D mesh (a meshed volume) with mesh diagonals small enough to provide the necessary shielding at the highest frequency to be controlled (see 5.12).

The boundary of an EM Zone does not have to have a uniform mesh size all over. For example, Figure 22 sketches different mesh sizes being used for different parts of an EM Zone 1's RF Reference, according to the different 'highest frequency to be controlled' in each part of the site. In this example, the power distribution room has no RF EMC requirements so the mesh there is just enough to provide the sufficient fault current handling. In the instrumentation room there needs to be a mesh sized to control the frequencies relevant to achieving the EM characteristics for the instrumentation, and in the computer room there is a different sized mesh because the frequency range to be controlled is different.

Existing metal structures can be interconnected to help create meshed EM Zone boundaries, and in industrial applications there is often so much of this 'natural' metalwork available that adequate conductive meshes can be created easily at low cost, with little need to add extra conductors, as shown in Figure 23. Bonding cable shields at both ends (see 5.7.6), and bonding cable trays and ducts to equipment cabinets at both ends (see 5.7.1), also help to improve MESH-CBNs – and reduce the impedances of meshed RF References – by providing many parallel bonding paths and opportunities for more cross-bonding between metal elements.

Figure 22 Example of different mesh sizes in an RF Reference in one EM Zone

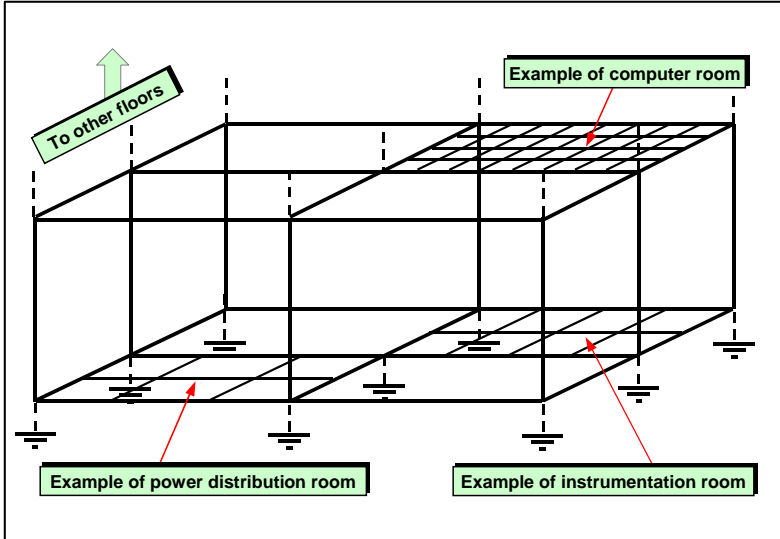

Figure 23 Creating a MESH-CBN by bonding 'natural' metalwork

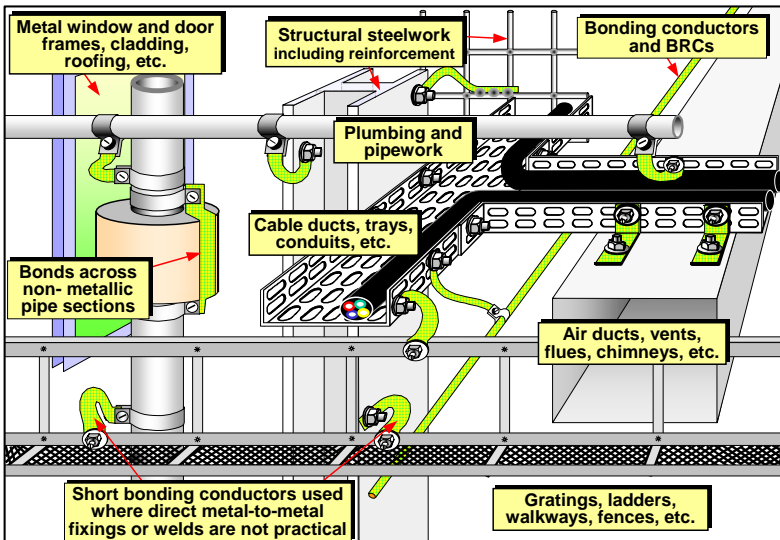

Figure 24 shows how the MESH-CBN for a multi-level IT or telecomm building might be designed. Each floor has its BRC and its RF Reference, and they are all interconnected with the rest of the building's MESH-CBN both horizontally and vertically, using 'natural' metalwork where possible (such as re-bars) but adding metalwork or bonding conductors where the mesh is too large.

Because of the huge volume of very sophisticated electronic equipment and data cabling associated with Data and Telecommunication centres, they need to use RF References that maintain low impedances up to at least 30MHz. The author understands that since the late 1990's some internet server

manufacturers have been specifying a maximum ground potential difference of no more than 15mV at any frequency of concern over the area occupied by their interconnected computers, just so that they function reliably, never mind ensuring their EM emissions comply with the new EMC Directive [1].

To achieve this, data and telco centres typically place their equipment on – and bond it to – a closely-meshed area of MESH-CBN that their standards and guides (e.g. [50] [53]) usually call a 'Bonding Mat' or 'System Reference Potential Plane' (SRPP). An example is sketched in Figure 25.

Figure 24 Example of vertical mesh bonding in a MESH-CBN

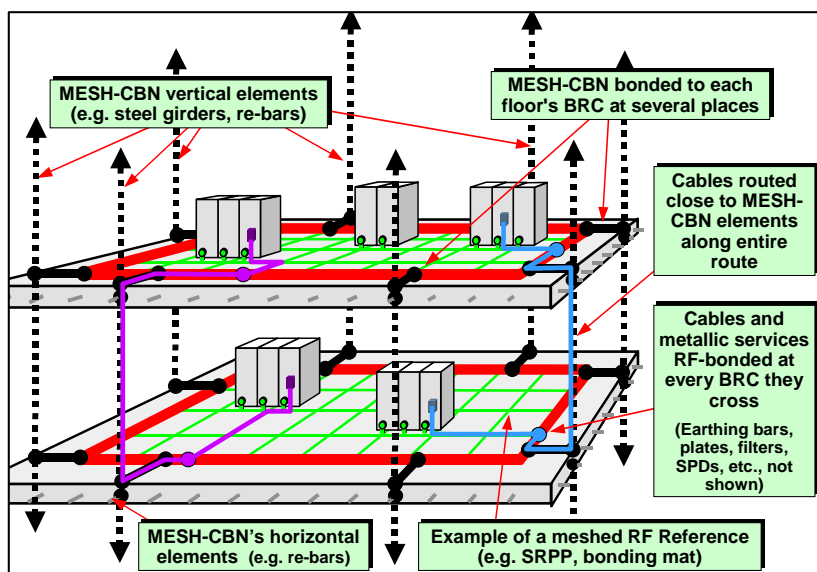
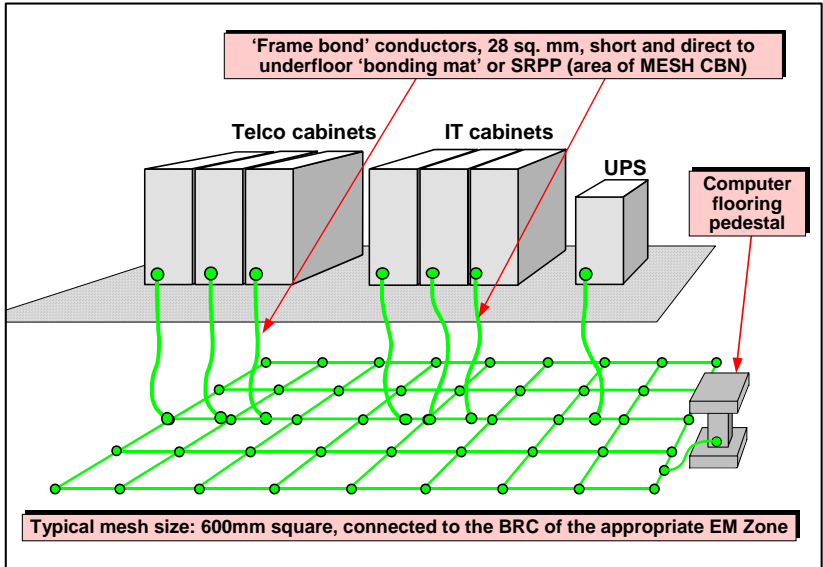

Figure 25 An example of an area of MESH-CBN providing a Bonding Mat or SRPP for a data centre



Other applications than servers or telecommunications could also have large concentrations of electronics, or critical equipment, that require RF References with similar (or lower) impedances for reliable functioning (see 3.1), and/or so that EM mitigation measures can reduce their emissions sufficiently for legal EMC compliance (see Section 1). So they might also use a closely meshed structure like that shown in Figure 24. For example, high-power motor drives can create very high levels of EM disturbances at frequencies up to at least 10MHz. Although f_{max} is not very high, the very high levels of the EM disturbances might make it necessary to use a closely-spaced 'bonding mat' as the RF Reference.

Where the EM environment suffers from EM disturbances that go beyond the immunity specifications of an installation's equipment, a high-specification RF Reference might be required so that EM mitigation provides effective attenuation. A MESH-CBN like that shown in Figure 25 might be what is required.

Typically these bonding 'mats' use a mesh of copper wire or lightning tape on a 600mm grid, installed beneath the computer flooring and bonded to the equipment cabinet frames by 28 sq. mm conductors (e.g. 6mm diameter) no longer than 500mm. Some companies use the metal support framework for the raised computer flooring, and/or metal-backed computer flooring tiles, as a bonding mat/SRPP. Turning the floor

tiles over, so their metal backing is now on top, makes it easier to bond the bonding mat to the frames or cabinets of the equipment.

When using metal backed floor tiles as the bonding mat, special care needs to be taken over the way the floor tiles' metal backing is bonded together. The intention of the metal backing on the tile is to help prevent large electrostatic discharges (ESD) caused by people walking on the carpet or vinyl surface. The bonding provisions for ESD control are often not very rugged and often become high-resistance or even fail altogether when a tile has been lifted and replaced a number of times, or when insufficient care is taken about placing feet. The result of such damage is often acceptable for ESD, but can ruin an RF Reference.

Although each application will differ, a 600mm meshed bonding mat as sketched in Figure 25 ought to at least achieve the old IBM specification (ground potential differences < 1V over a computer room). But where better control and/or higher frequencies are required (e.g. where the specification is 15mV and communications use Gigabit Ethernets or other very high-rate datacommunications) the mesh size may need to be much smaller – a metal sheet is best – and the equipment frame bonds much shorter. It is not unrealistic in some applications to install a seam-bonded metal floor, stand the equipment cabinets directly on the metal floor, and bond them to the floor with very short straps, maybe even one at each corner or one every 300mm or so around each cabinet's perimeter.

5.5.5 Mesh bonding on single-point bonded legacy sites – the MESH-IBN

Older (legacy) buildings often use single-point earthing (see Figure 20) and there are serious concerns that adding a meshed RF Reference might cause 'ground loop' problems for the existing equipment. In such cases, to save having to convert the whole building or site to a MESH-CBN, some authorities and standards suggest the use of insulated meshed bonding networks (MESH-IBNs) when adding data and telco centres, or other concentrations of sophisticated electronic equipment, see [43] [50] [51] [61] [63] ([32] has more details and references). Some of them also recommend modifying the entire building or site to use MESH-CBN construction at the earliest opportunity. [61] is probably the most comprehensive reference, and is often referenced by other standards for its MESH-IBN details.

MESH-IBNs should be constructed to have at least 10kV of isolation from the rest of the building's bonding network, when their connections to the rest of the building are opened. This is so that during thunderstorms, dangerous flash-overs from the existing building's earth structure to the MESH-IBN are unlikely. MESH-IBNs should have their own BRCs and their main earthing terminal is called their 'single-point of connection' (SPC). The SPC is the one point where the MESH-IBN is bonded to the building's existing earthed structure, ideally to a low-impedance (at 50Hz) earthed conductor such as a cable duct. All cables and conductive services must enter the MESH-IBN close to the SPC, and be RF-bonded at the SPC (either

directly bonded, or indirectly bonded via SPDs and/or filters).

No exceptions are allowed – no cables or conductive services may enter at

other points. Figure 26 sketches the main points of MESH-IBN construction.

Figure 26 Adding a MESH-IBN to a legacy building

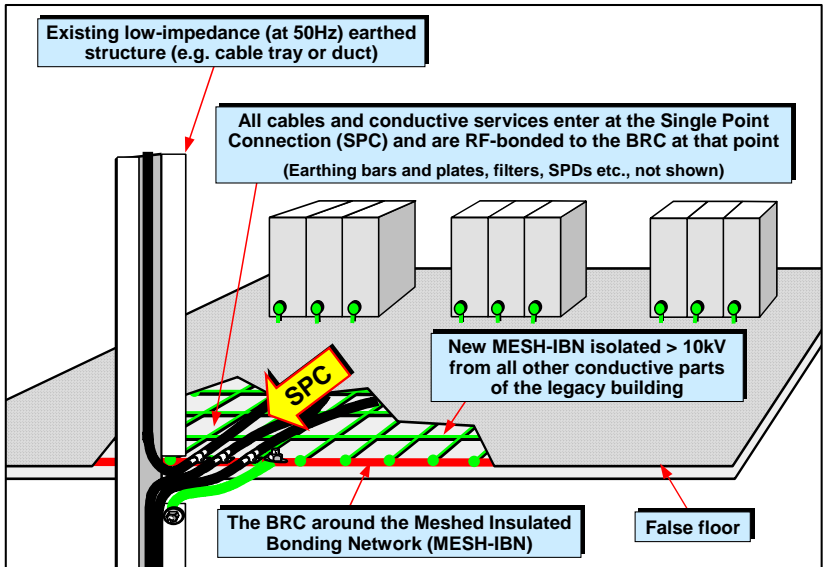

Although MESH-IBNs can work very well indeed when first installed, they must be designed taking into account lightning and surge protection for personnel. It must be impossible by design, for safety reasons, for anyone to be able to touch equipment bonded to the MESH-IBN and any other equipment or structure on the site. Consequently, MESH-IBNs are very vulnerable to 'craftsmen', who may, for example, remove a partition or convert a wide walkway into a smaller one and install equipment that can be touched.

MESH-IBNs are also very vulnerable to technicians and engineers, who may

decide to run a data or power cable between two areas or rooms, or even between floors, not realising that they are compromising the isolation of the new area. Such additional cables can cause serious risks of electric shock and/or fire, never mind EMI.

As a result, MESH-IBNs need to be regularly inspected and maintained throughout their life, by electrical engineers who fully understand their concepts and requirements and have the necessary authority to control that part of the installation. Where a site relies upon contract electrical engineers and has no chief electrical engineer permanently

employed to oversee the electrical networks, it is safest – and also best for EMC – to avoid MESH-IBNs and use a MESH-CBN instead.

In fact, the same is also true for ‘traditional’ single-point bonded systems (see 3.5). If they have any complexity, then over time they generally suffer from some accidental or unforeseen ‘ground loops’ that can be difficult to discover. For example, sites where professional audio or video systems are installed, which employ traditional single-point safety earthing/grounding networks, often suffer from audio or video noise when new ground loops are accidentally created by the installation of a new item of equipment, new cable, or by an insulation failure.

Such problems can take days, even weeks to resolve, with no guarantee that another such problem will not occur next week. But when they are constructed using MESH-CBNs instead, such problems cannot occur – every new ground loop simply improves the mesh and improves the overall noise

performance and EMC. See 5.8 for why ground loops do not cause a problem for correctly-designed equipment, and how to easily deal with poorly-designed equipment.

5.5.6 Mesh-bonding in legacy sites – mixed bonding structures

5.2.3 discussed buildings or sites with full MESH-CBNs, and 5.2.4 discussed MESH-IBNs, but in fact there are an infinite number of ‘mixed’ styles of common bonding network that can be used, as shown in Figure 27. These are very useful when modifying a legacy structure, which may be using single-point bonding, or a mesh that is too open for the RF Reference for the new equipment.

The key issue that controls all of these is the EM characteristics specified for each EM Zone, which comes from the EM specifications for the equipment and the EM environment that they would be subjected to if the EM Zones were not present.

Figure 27 Examples of mixing CBN styles

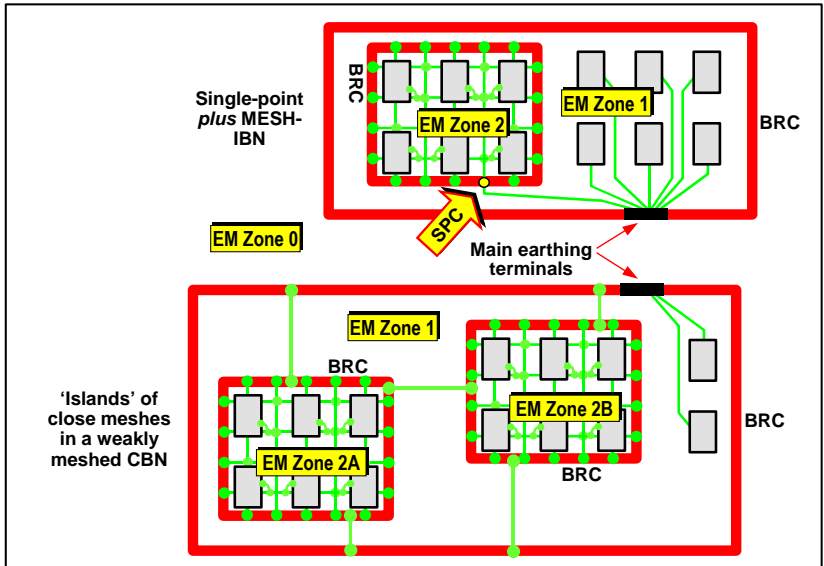

5.6 What if you really cannot use mesh-bonding?

For example, what if certain situations do not permit cable shields or armour to be terminated at both ends, or the use of a PEC? Such restrictions might, for example, be applied by some safety standards governing the installation or electrical/electronic equipment in explosive atmospheres.

Another example is when working on a legacy installation that is constructed according to the traditional (but long-since outdated) single-point earthing/grounding/bonding concept (see 3.5).

The best approach from an EMC point of view is to persuade the safety authorities (in the case of explosive atmospheres), or the owner (in the case of legacy

installations), that your use of mesh-bonding techniques will not cause problems with aspects of safety or performance other than EMC. Of course, such persuasion should be based on an appropriate amount of investigation and analysis, which proves the case in appropriate detail, so as not to expose anyone to uncontrolled safety, financial or political risks. Converting a legacy installation to MESH-CBN can be a time-consuming and costly operation that is not to be undertaken lightly.

If the above approach was not attempted, or has not succeeded, the best approach is to mesh-bond as many areas as possible, creating a different EM Zone for each area, each with its own BRC. The BRC of each should be connected to the rest of the structure at only one point, as shown in the discussion of the MESH-IBN technique

in 5.5.5. Then only connect the equipment inside each EM Zone to the rest of the system/installation using the galvanic isolation devices described in 4.3, making sure they are rated for the maximum fault and lightning surge voltage that could occur.

Galvanic isolation methods should be installed at the boundary of the EM Zone, as described in detail in 4.7 and 5.4.

Where it is not practical to provide galvanic isolation for a conductor, it should be appropriately filtered and/or shield bonded and/or surge protected at the point where it crosses the BRC – with the filter, shield-bond or surge protection device RF-bonded to the BRC at that point, using the techniques described in this Guide.

5.7 RF-bonding techniques

5.7.1 Direct bonding

Bonding should ideally be direct metal-to-metal connection between metal surfaces that have highly-conductive surfaces (see 5.7.2) and are protected against corrosion (see 5.7.2 and Section 7) as shown in Figure 28. Short bonding conductors can be used instead, as shown in Figure 29, which grades the conductors from 4 (worst for RF) to 1 (best for RF).

NAVAIR AD 115 [45] has some graphs of the effectiveness of braid bonding straps with frequency, and shows that a single 9½ inch long braid strap is

useless (or even counter-productive) above 10MHz when bonding a standard equipment cabinet to a metal plane. This is because the unavoidable stray capacitance of the cabinet is resonating with the inductance of the bonding wire, an example of the kind of complex EMC interactions that makes simple calculations so unreliable.

When there is no practical alternative to using a conductor for RF-bonding, their poor performance at RF can be improved by using two or more, spaced as widely as possible along a seam or joint. For example, with respect to Figure 25, instead of a single 6mm diameter conductor bonding a cabinet to its RF Reference, four conductors of the same length could be used, one connected at each corner, to reduce the bonding impedance to one-quarter of the single wire situation.

Bonding conductors that are connected in parallel should always be spaced as far apart as possible (see Figure 13) because this minimises the overall inductance – no RF benefit is obtained if they are routed close together.

Aggressive ‘spiky’ washers and screw threads that bite through paint and oxide films can be used to bond metal parts together, or to terminate cables to metal, but this is not a good method and should not be used when designing a mesh. However, it may be the only practical approach when trying to improve the meshing of an existing installation.

Figure 28 Metal-to-metal RF-bonding (always preferred)

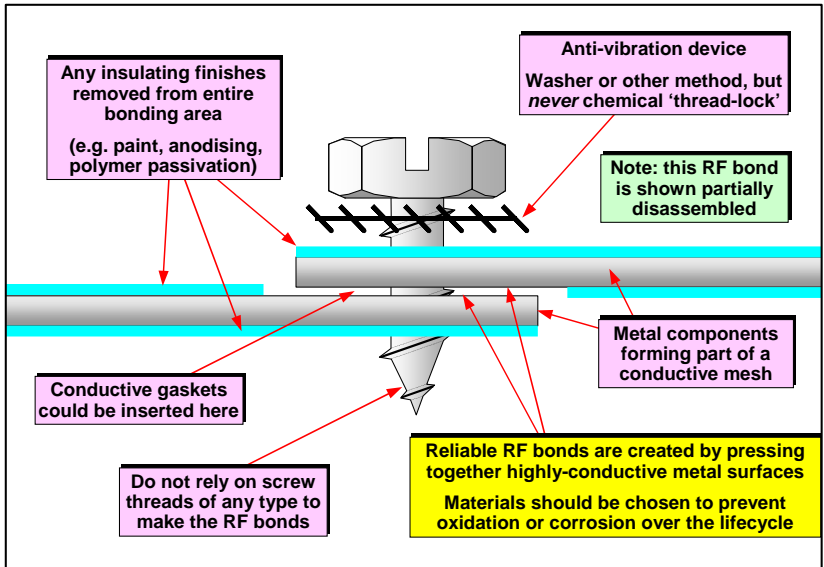

The best method of bonding two metal components together is to seam-weld them all along the perimeter of their common seam. This method is used for steel, stainless steel or aluminium components in some very high-reliability installations. Dissimilar metals can be 'cadwelded', for example to bond a copper conductor to a steel girder. Conductive gasketing (see 5.7.4) can also be a practical alternative.

It is generally best to design installations so that all their metalwork is conductively plated, with no paint or other insulating finishes applied (see 5.7.2). Then very good and reliable RF-bonds can easily be created by using mechanical fixings of various types to press the conducting metal surfaces together, as shown in

Figure 28. Conductive gaskets (see 5.7.4) could be squashed between the conductive metal parts to spread the contact area even wider.

Where it is not practical to use metal-to-metal RF-bonds as shown in Figure 28, the use of multiple short conductors, or better still short wide straps, widely separated from each other along the whole length of a joint or seam, achieves more effective RF-bonding at higher frequencies than a single conductor. Figures 30, 31, 32 and 33 sketch some examples of using various types of bonding conductors from Figure 29 and metal-to-metal fixings from Figure 28. Numbers grade the performance of the bonds from 4 (worst for RF) to 1 (best for RF).

Figure 29 Examples of RF-bonding conductors

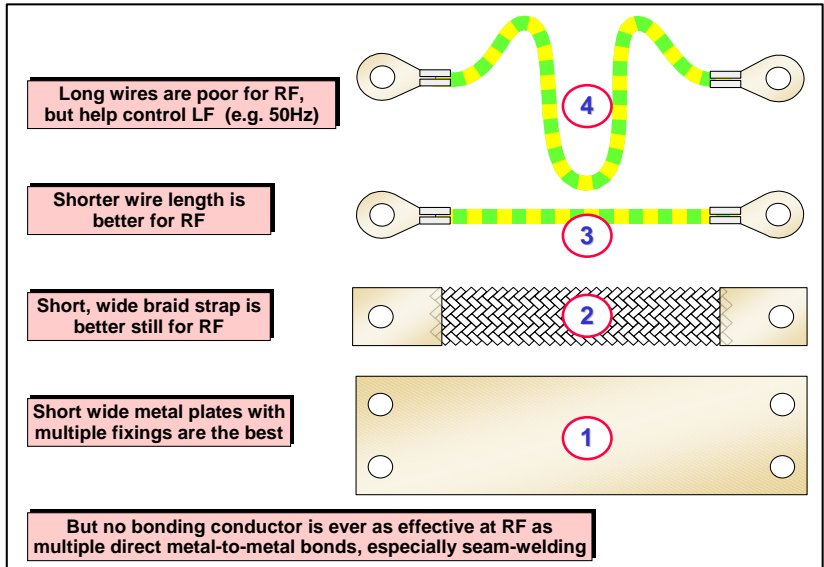

Metal-to-metal RF-bonds in a MESH-CBN should generally be spaced apart much less than $30/f_{\max}$ metres (f_{\max} in MHz) – but joints in cable trays, ducts, conduit, and any other metalwork that is part of the MESH-CBN and is also used as a cable support should be spaced no more than $3/f_{\max}$.

For example, for a MESH-CBN that is intended to control frequencies up to 30MHz, the general spacings between RF-bonds in the structure (e.g. at joints in sheet metal, or between meshed areas such as rebars) should be no greater than 1 metre, and preferably a lot less. But for bonds in cable support systems such as trays, ducts, etc., or

any other parts of the MESH-CBN where cables are routed closely, the RF-bonds should be spaced no further than 100mm apart, and preferably less.

Seam-welding is always the preferred technique for RF-bonding any seams and joints in MESH-CBNs, but due to its cost is generally only used in military command and control underground bunkers and other applications intended to survive nuclear attack, see 5.13.4. However, it is a powerful technique that gives very good results for EMC, and is reliable over decades of operational lifetime, so it deserves to be considered in all applications.

Figure 30 Examples of RF-bonding techniques

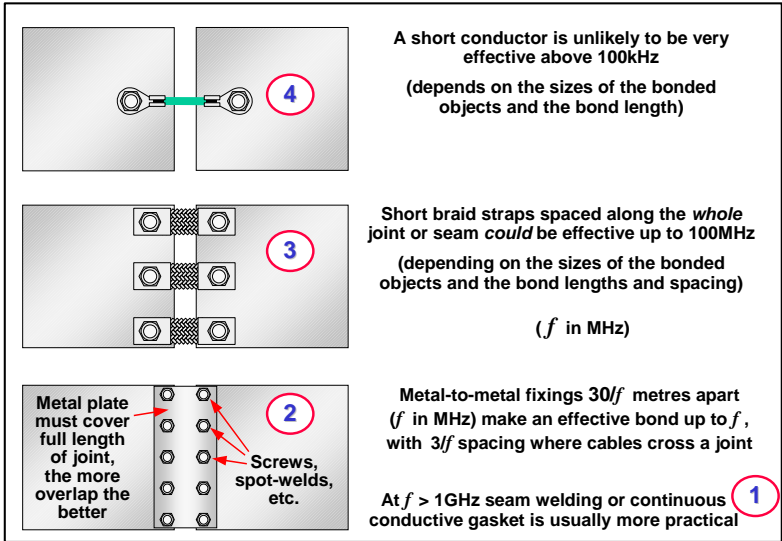

Figure 31 Examples of RF-bonding techniques for joints in cable trays and ducts

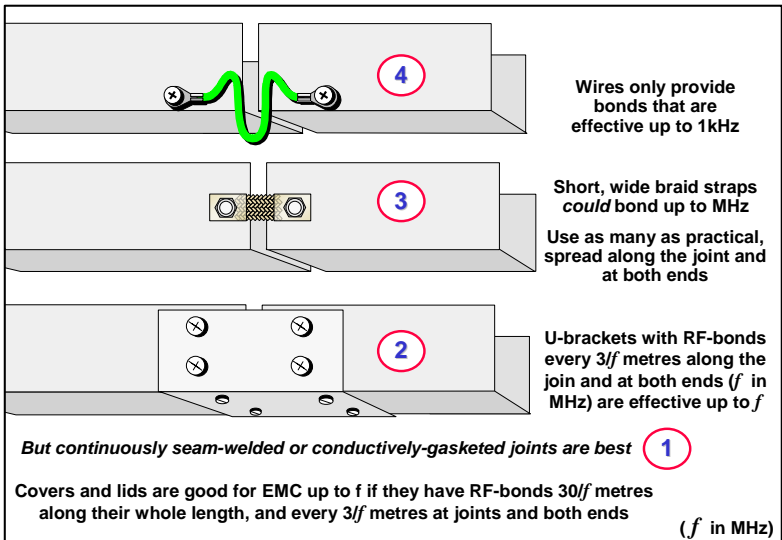

Figure 32 RF-bonding techniques for trays, ducts, and metal enclosures

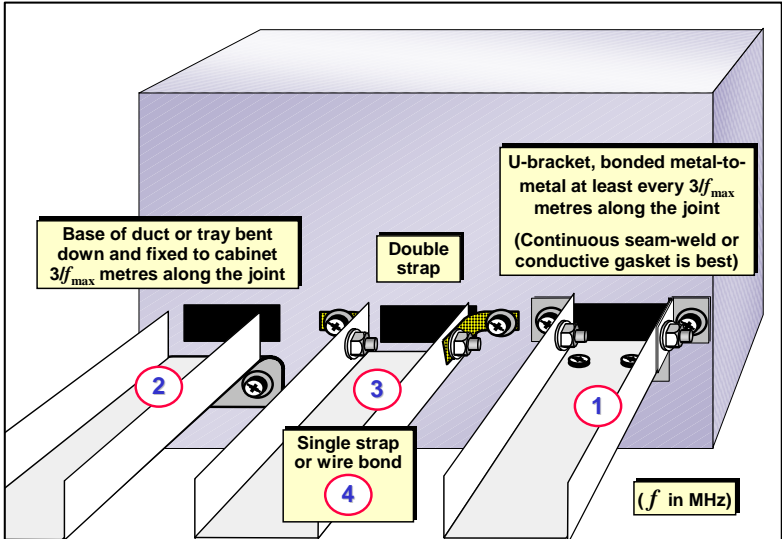
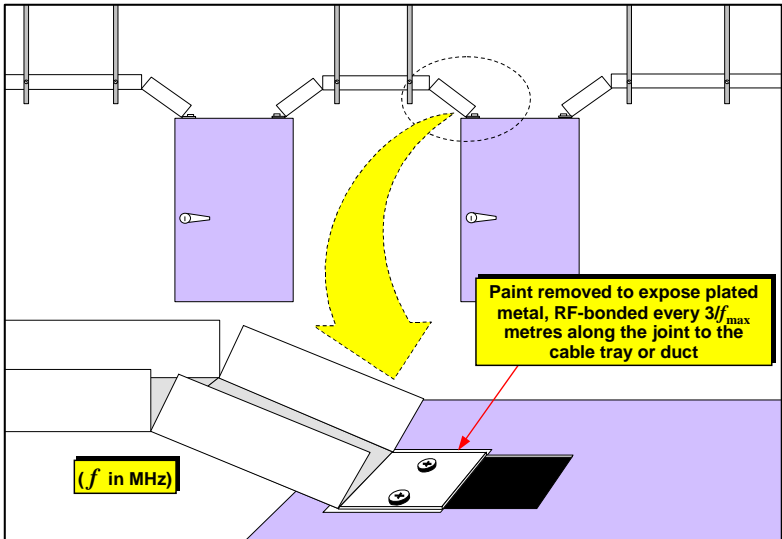

Figure 33 Some more RF-bonding techniques for trays, ducts, and metal enclosures



Solid circular conduit can provide truly excellent EMC performance for cables routed in it, but only one Class is permitted in any one conduit (see 4.8). To achieve this it is necessary to make reliable low-impedance 360° RF-bonds at all joints along the conduit by using threaded couplers, and also to make reliable low-impedance RF-bonds to the chassis/frames/enclosures at both ends. Unfortunately, the usual conduit end-

fixing is unsuitable, as it relies upon a length of green/yellow wire to bond it to the chassis/frame/enclosure.

Figure 34 shows an example of a product that has been developed specifically to RF-bond conduits to equipment cabinets, and achieves about 30dB better SE up to 200MHz, than the usual conduit termination.

Figure 34 Example of an RF-bonding conduit termination

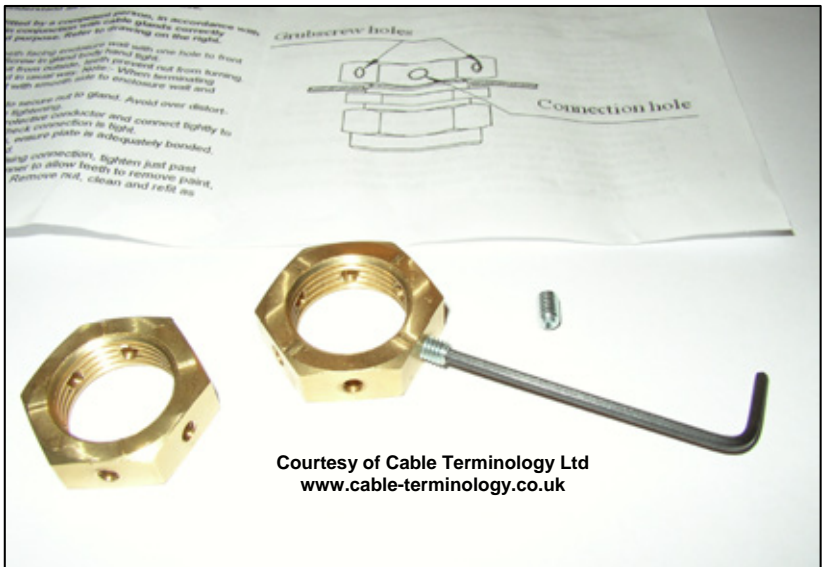

5.7.2 Assembly issues

It is very important that, immediately before assembly, all electrical and RF-bonding surfaces are clean, dry smooth and free from oxides, tarnishing, or fingerprints. This encourages microscopic cold-welds to be formed at pressure points when the joints are

assembled, reducing the bond's impedance and prolonging its useful and effective life. If necessary, use gentle abrasives to achieve suitable surfaces – a slight roughness is desirable, but take care not to remove any plating.

Fixings should also be 'torqued-up' to the specified value, using calibrated tools. A loose fixing that allows movement, will encourage fretting

corrosion that quickly leads to poor EM performance.

There are liquids, gels or greases specially designed for use in/on electrical bonds, to give them longer life, especially in challenging environments – for example the rail industry uses greases formulated with a very high percentage of metal dusts.

But chemical threadlocking compounds must *never* be used on any electrical joints, whether they are intended for RF-bonding or not – because they penetrate the joint and cause unpredictably high impedance. The author has seen a 4mm stud fitted with a ring tag and nut, that when assembled as usual had a resistance of about 1mΩ, but when assembled with a common chemical threadlock and torqued up just as tight, measured 8Ω.

So, fixings must only be prevented from loosening due to vibration by mechanical methods, such as locknuts, split pins, anti-vibration washers, nyloc nuts, etc.

5.7.3 Materials for reliable RF-bonding

For the easiest RF-bonding and mesh construction, and to help maintain good EM characteristics over an installation's operational life, we use metalwork and other conductors with corrosion-protected electrically-conducting high-conductivity surfaces, for example:

- Tin or zinc plating (tin plating preferred, and can be applied to steel, copper, aluminium)
- Galvanised mild steel (but tin or zinc plating is better)
- Stainless steel

- Aluminium (tin plated, or conductively passivated by 'Iridite-NCP' or alochrom, *never* anodised)

Over time, the conductivity of metal surfaces always degrades due to fretting and/or oxidation, and also due to galvanic corrosion at dissimilar metal joints, see Section 7. Plating and/or passivation with suitable materials can prevent both types of degradation, or at least slow its progress appreciably. Silver or gold plating is the best, but for cost reasons is usually only applied to small parts and so is more likely to be used in high-specification equipment rather than in metal structures and wiring in installations.

Oxidation is very obvious with steels, which (with the exception of stainless grades) all rust, and of course rust is a poor conductor. Coppers and brasses also oxidise, but in polluted environments sulphates or sulphides might dominate, so they can turn a variety of colours between green and black, all of which are poor conductors.

What might not be so obvious is that aluminium also oxidises, but its 'rust' is aluminium oxide, which is grey and hard and looks very much like metal. New aluminium has a thin oxide skin that is easily penetrated by reasonable amounts of contact pressure, but aluminium that is a year or two old or more will have quite a thick oxide layer. Aluminium oxide is much harder than aluminium (unlike rust which is much softer than steel), and is one of the best insulators known – making plain aluminium an unsuitable material for general construction use where RF-bonding is required.

Anodised aluminium is just aluminium in which the oxidation process has been

hastened by chemical action, and is a very good insulator. To make a good RF-bond (or any reliable electrical contact) to anodised aluminium requires machining the surface to remove the very hard layer of anodising, exposing the plain aluminium – which then immediately starts to oxidise, so needs a protective coating to be applied (e.g. silver-loaded paint).

To help prevent both types of corrosion, it is best to standardise on one type of plating for all the constructional metalwork that might be meshed to create an RF Reference. For example, tin plating can be applied to many metals (e.g. steels, coppers, brasses) and also to aluminium (although it is not a low-cost process for this metal) so that joints between metal structures and bonding conductors do not suffer galvanic corrosion when exposed to liquids even though their base metals are different (see Section 7).

A variety of metal tapes with pressure-sensitive conductive adhesive backing are available from companies such as 3M, which can be used to provide a good high-conductivity bonding surface (usually tin) instead of relying on plating.

Where a painted finish is required, it is very messy and unsatisfactory to remove paint or anodising wherever an RF-bond is required. Apart from anything else it tends to remove the base metal's protection, and unless the exposed metal is then protected with brush-on tin plating, conductive paints or greases, oxidation and corrosion will occur and cause poor RF-bonding quite quickly.

Some types of conductive metal tapes are available with an extra layer of masking tape. They are applied to the area to be bonded, before painting. After

painting the masking tape is removed to reveal the shiny metal surface where the bonding is to take place.

Beware of metal passivation. Chromate passivation based on hexavalent chromium (Chrome-6) is always acceptable, but is being phased out due to the very serious risks of cancer caused by the chemicals used in its processing. A variety of new methods based on fluorine (e.g. Iridite-NCP, for aluminium) or alochrom (for aluminium) based on trivalent chromium (Chrome-3) have been, and are currently being developed, and some of them are proving better than Chrome-6. However, some of them might not create the necessary highly-conductive surface over the lifetime of the installation, so always check.

But a big problem is that many metal suppliers and finishers automatically apply a polymer passivation film, even if their customer did not request it (and sometimes even when it was specifically prohibited). Like anodising, this type of passivation creates a non-conductive, insulating surface that makes it very difficult to create reliable conductive meshes. It is recommended to always check whether a polymer passivation has been applied, and check all metal deliveries with an ohmmeter and smooth/soft contacts (using soft conductive gaskets to make contact rather than pointed probes or plug pins), to make sure they really do have a highly conductive surface.

'Zintec' steel is a popular material, being sheet steel that is already zinc plated and so resistant to corrosion even if left unpainted. Unfortunately, the standard 'Zintec' grades are finished with a top-coat of polymer film passivation, making

the surface non-conductive. Also, the zinc plating is so thin (about 5 microns) that without the polymer film the metal can corrode quite quickly. Thicker zinc plating and no polymer passivation film coating would be very much better for RF-bonding and constructing a mesh.

A different approach may be to use the recently-developed vapour-phase corrosion inhibition technique [64], which claims to reduce the rate at which oxidation and galvanic corrosion occur.

5.7.4 Using conductive gaskets

Using multiple metal-to-metal fixings (screws or spot welds), as shown in Figures 30 - 32, generally provides good RF-bonding performance. But achieving effective bonding above about 500MHz requires so many that assembly time can become prohibitive. As mentioned in 5.7.1, continuous seam-welding, brazing or soldering around the perimeter of the mating parts is the best method of creating long-term reliable RF-bonds that work up to the highest frequencies – but it is not always practical, and soldering might not be reliable.

An alternative can be to use conductive gaskets, often called EMC gaskets, to provide low-impedance bonding all around the perimeter, or over the entire mating area, of a metal joint. These gaskets are most often used to create shielded enclosures (see [36] and [65]), and the way in which they are used to help create good RF-bonds in conductive meshes is no different. Multiple screw fixings are still required, but in this case their job is to provide sufficient pressure to compress the gasket optimally over the entire length or area required – and the resulting RF-bond is good to GHz.

Alternatively, where GHz bonding is not required, short pieces or 'dots' of gasket can be used to multiply the number of bonding points whilst using fewer fixings, saving time during assembly or disassembly.

There are many suppliers of such gaskets, and each one offers very many different gasket materials in many different styles (see Figure 35 and Figure 36 for some examples of gasket materials) because no one type of gasket is suitable for all applications.

This Guide will not discuss gaskets and their use in any detail (for which see [36] and [65]) – except to say that when assembled they should be compressed to an amount within their manufacturers recommended range, which can require considerable pressure.

Good EMC gasket manufacturers provide a wealth of data and application assistance (for example [66]), covering the correct choice of gasket materials and styles for particular applications, and the data required for correct mechanical design.

Even gaskets that are easily squashed flat between two fingers can require very large compression forces when used in long strips (e.g. around doors, see 5.12.13), so the effective use of gaskets requires careful mechanical and fixing design to prevent metal parts from bending too much. Where a very long joint is to be gasketed it usual to fit a long strip of a relatively soft conductive gasket, only to find that the total force required to compress its long length causes the metal parts to bend inbetween the fixings – opening up gaps that defeat the purpose of the gasketing.

Figure 35 Some examples of conductive gaskets

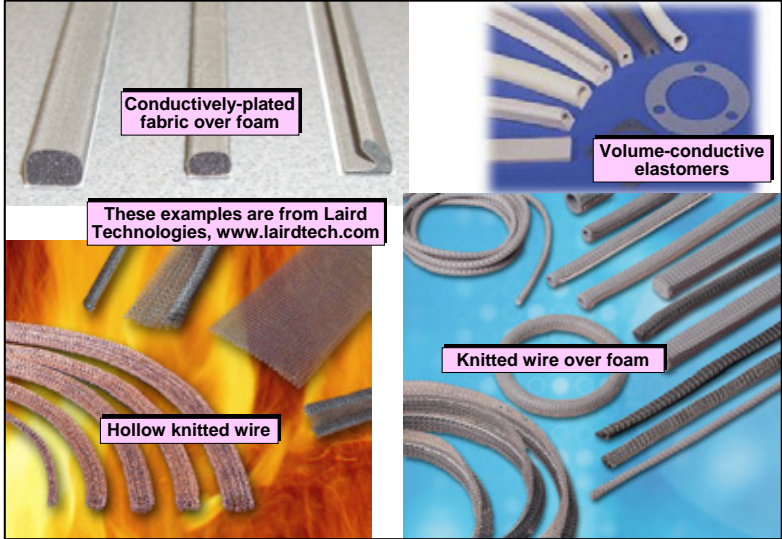
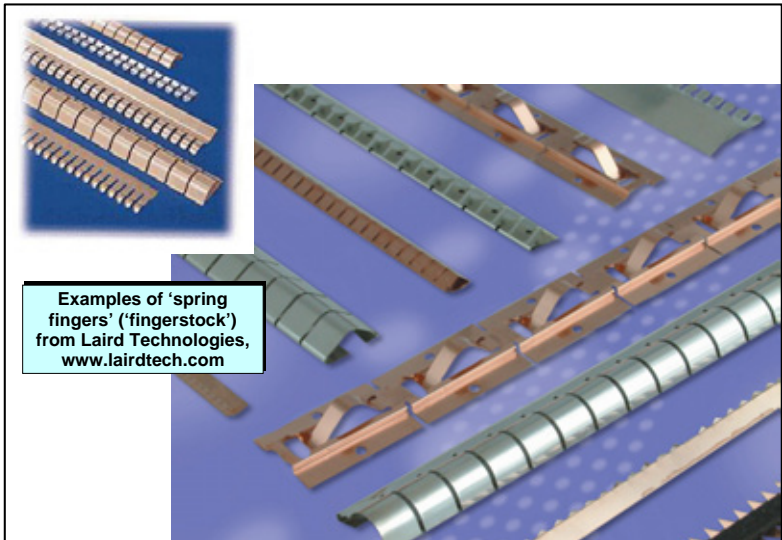

Figure 36 Some examples of fingerstock (spring finger gaskets)



5.7.5 Direct and indirect RF-bonding of conductors crossing a BRC

All conductors must be RF-bonded to the boundary of an EM Zone (usually its BRC) when they cross it to enter that EM Zone. 5.7.1 to 5.7.4 described direct bonding techniques that can be used for metal parts and conductors forming a conductive mesh, such as the MESH-CBN, and these techniques can be used to directly bond any conductors as they cross a BRC. 5.7.6 goes into more detail about how these methods should be applied to cable shields and armour, and any circular conductors such as conduit.

Unshielded signal, data, control and power conductors obviously cannot be *directly* RF-bonded to an EM Zone boundary, because that would short them out. Instead, they must be *indirectly* RF-bonded through an EM mitigation device such as a filter (see 5.10) and/or surge protection device (see 5.13).

Galvanic isolation (see 4.3) is an alternative EM mitigation method that can be used at an EM Zone boundary, with the Reference for the isolated signal or power that passes into the EM Zone being RF-bonded at the zone's

boundary. All EM mitigation devices should be chosen to achieve the attenuation required for the EM disturbances crossing the boundary of an EM Zone, to achieve the necessary EM control required for that zone.

Figure 37 shows examples of direct RF-bonding (cable shield clamping) and indirect RF-bonding (filtering) at a BRC, using a 'bonding plate' inserted into a BRC for that purpose.

Figure 37 is clearly a very simple installation, and it is more likely that all the RF-bonding will be contained within an industrial cabinet, using its backplate as the main earthing terminal. Such a cabinet is shown in Figure 38, and is large enough to have room for fitting all the direct and indirect RF-bonding devices for the quantity of cables, whilst easing their assembly (e.g. DIN-rail mounted surge protection devices) and ensuring good low-impedance RF-bonds to the BRC. This type of cabinet, with BRC connections to its backplate on both sides, will be very familiar to electrical/electronic system designers who are familiar with designing for explosive atmospheres.

Figure 37 Example of direct and indirect RF-bonding at a BRC, using a bonding plate

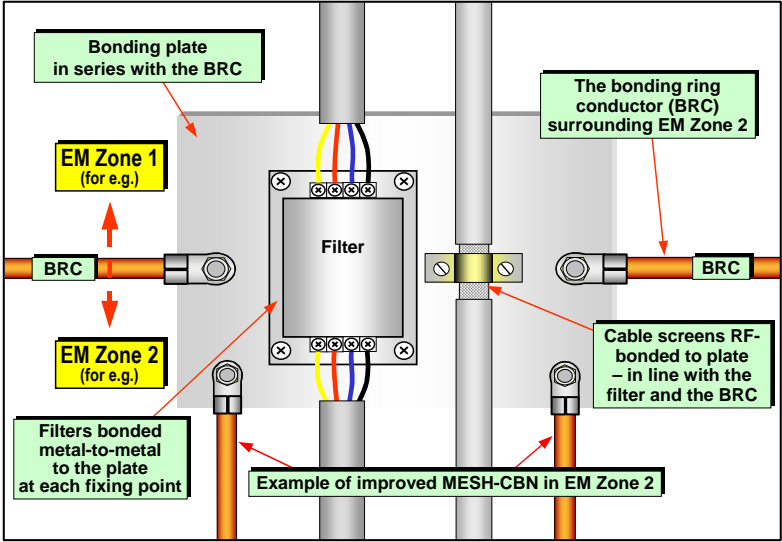
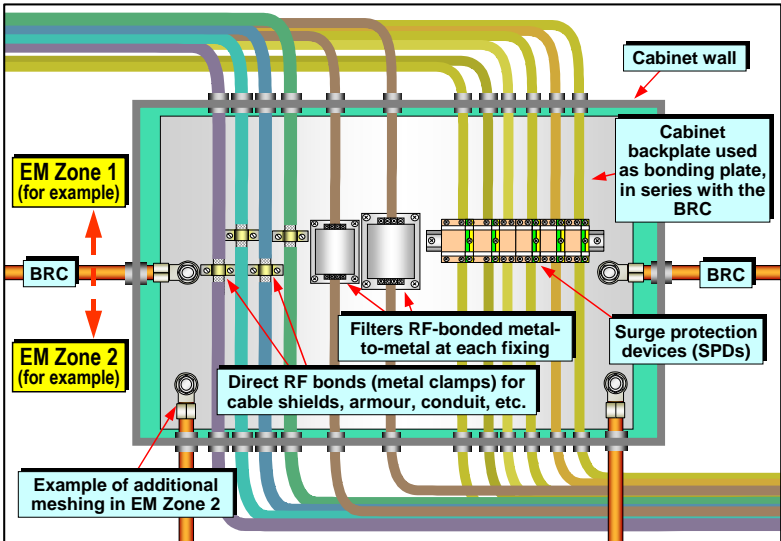

Figure 38 Example of direct and indirect RF-bonding at a BRC, using an industrial cabinet backplate



Neither Figure 37 nor Figure 38 show the direct RF-bonding required for other conductors, such as metal structures, pipes for gas, water, hydraulic fluids, pneumatics, etc., or for ducts for air conditioning, cables, etc.

Figure 39 shows one way of dealing with the RF-bonding for a cable tray that passes from one EM Zone to another. The red cross is meant to show that no conductors of any sort are permitted to cross the zone boundary without being RF-bonded to it either directly or indirectly.

Where non-conductive liquids or gasses cross from one EM Zone to another, an alternative to RF-bonding is to employ a length of plastic piping at the crossing point. The length of plastic piping should be at least 50mm, and the spacing

between the remaining metal pipes and the BRC should be at least 100mm. Metal pipes should all be bonded along with cables and other conductors at the main earthing terminal, but plastic pipes (or pipe sections) carrying non-conductive liquids or gasses can cross the BRC anywhere.

Ordinary water is conductive, and polluted water can be very conductive, so always check to make sure the fluids concerned really are non-conductive. Tribocharging can cause insulated sections of pipe to build up dangerous static potentials, so all metal pipe sections should be bonded to the BRC for safety reasons – but how this is done is immaterial for EMC as long as any bonding conductors remain within their respective EM Zone.

Figure 39 Example of direct and indirect RF-bonding at a BRC, for a cable tray

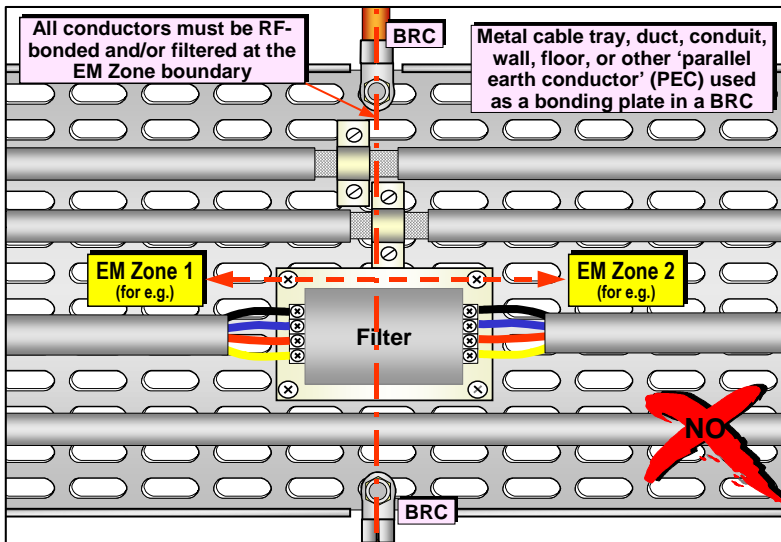

5.7.6 Direct RF-bonding of cable shields, armour and conduit

As mentioned earlier, cable shields, metal armour and metal conduit should be RF-bonded at the points where they cross each and every BRC (i.e. as they cross from one EM Zone to another), even if they are also RF-bonded within a zone. Figures 37, 38 and 39 show some examples of direct bonding of shields as they cross a BRC, and this section discusses how to do cable shield bonding in more detail.

Figures 37-39 show the shields being bonded using metal saddleclamps of the type more commonly used to clamp pipes. Obviously, the outer jacket of the cable must be removed to expose the shield so that it can be bonded, and where this exposes the cable to harm it should be done inside a protective cabinet (as in Figure 38). Metal P-clips are often used instead of saddleclamps, for ease of assembly (they only have one fixed screw instead of two), but their RF-bonding performance is not as good above 50MHz. Very few EMC suppliers offer anything as simple and low-cost as metal saddleclamps or P-clips, so they

are often purchased from plumbing, pneumatic or hydraulic suppliers (see Figure 50).

Saddleclamps and P-clips must make a reliably tight fit around the shield, so the correct size should be used to coordinate with each cable. It is not good practice to rely on the thread of the screw fixing(s) to make the RF-bond – it is best if the metal clamp or clip makes a metal-to-metal contact with the highly-conductive surface of the bonding plate. In the case of saddleclamps, the shield of the cable should also be pressed metal-to-metal with the highly conductive surface (like Figure 29). Braid shields are easier to RF-bond than foil, see 5.7.10.

Shielded cable glands, often called 'EMC glands' can be used to RF-bond shields as they cross from one EM Zone to another, as shown in Figure 40. Because they make an electrical connection all around the circumference of a shield (or a multi-point connection all around) – the best way to RF-bond a cable shield or armour – they are often called '360° shielding glands'.

Figure 40 Using EMC glands at an EM Zone boundary

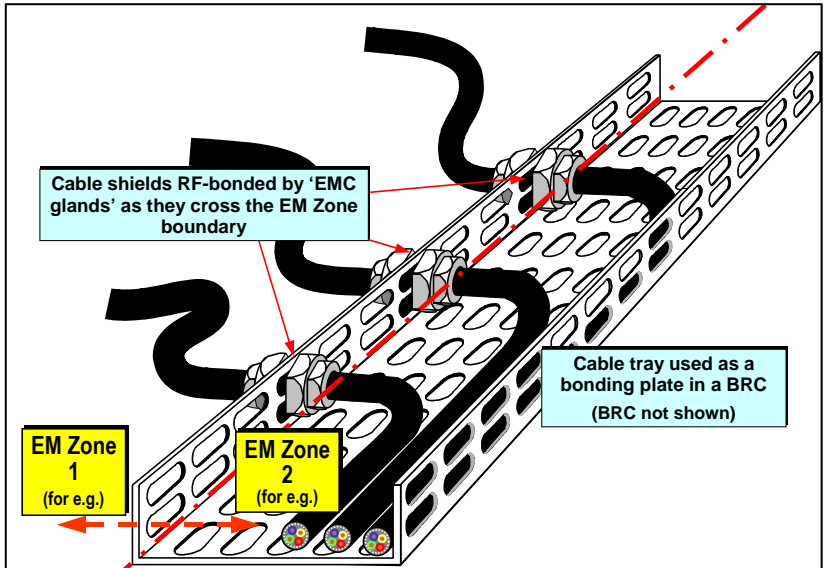

There are many types of gland available from commercial suppliers, and Figure 41 shows three types. Glands that bond with uniform pressure all around an undisturbed cable shield (e.g. a 360° bonding 'iris' spring or 'knitmesh' gasket) generally give the best RF performance, and an example of this type is shown in the top left of Figure 41.

The type shown at the bottom-left of Figure 41 relies upon the assembler cutting the braid and spreading it over a plastic part before assembling it to the metal part that provides the RF-bond to the RF Reference.

Although this type of gland has a lower cost, the extra work required to assemble it costs more, and there is also

the possibility that the assembler will not spread the cut braid evenly, or make other mistakes that degrade EMC performance. Also, because the shield cannot continue past the gland, this type is of limited applicability in an installation – it is only suitable where the gland is fitted in the wall of a shielded enclosure, so that the unshielded length of cable is inside the enclosure's shield. However, this may be perfectly adequate (bearing in mind the workmanship issues) for cables that enter or exit shielded terminal or junction boxes.

The gland on the right of Figure 41 tends to damage the cable shield if it is disassembled.

Figure 41 Three types of 360° shielding cable glands ('EMC glands')

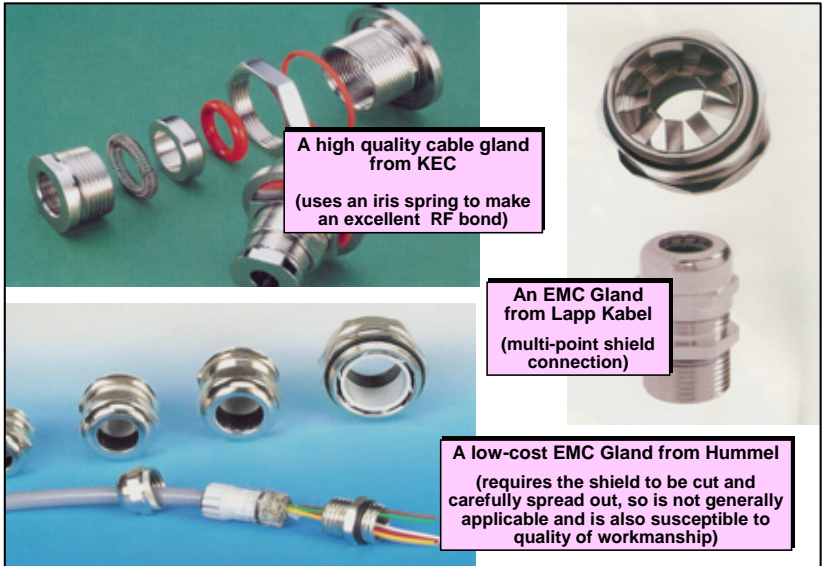

A variety of shield-bonding accessories is available from various suppliers, and as long as they provide 360° (full circle) metal-to-metal bonding *directly* between the cable shields and the *surface* of the local RF Reference (for example the bonding plates in Figures 37 and 38, or the cable trays in Figures 39 and 40), they will give good EMC performance. But beware – instead of direct metal-to-metal bonding some types rely on a wire or braid strap connection to the RF Reference. This makes them into pigtail connections, which are very poor for EMC above a few hundred kHz. Pigtails are discussed in 5.7.8.

Mass shield bonding helps save time during assembly, and some suppliers offer suitable products. But it is easy to design your own mass bonding facility, as shown Figure 42, a low-cost technique relying on clamping a number of exposed shields between conductive gaskets. The cables can be held in place by tie-wraps until they are all ready, then the clamping plate with its conductive gasket is fitted over their exposed shields. This type of assembly easily outperforms many of the proprietary shield-bonding accessories that are available.

Figure 42 Easily bonding multiple cable shields to an RF Reference (a)

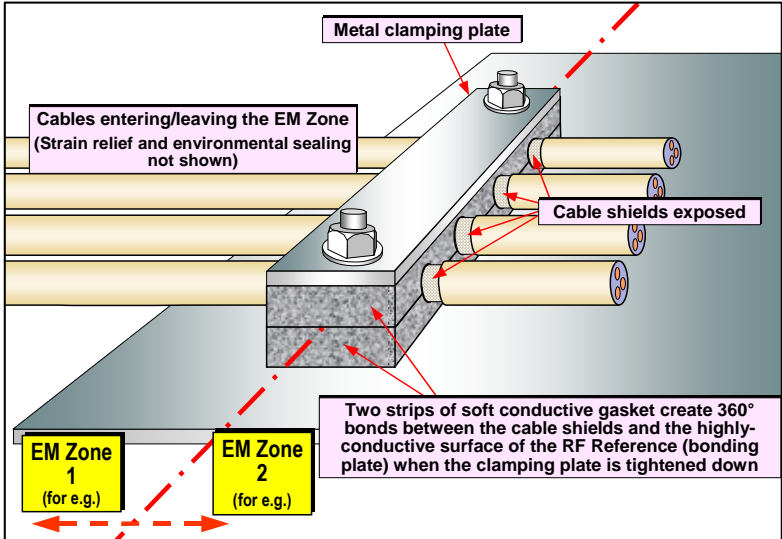
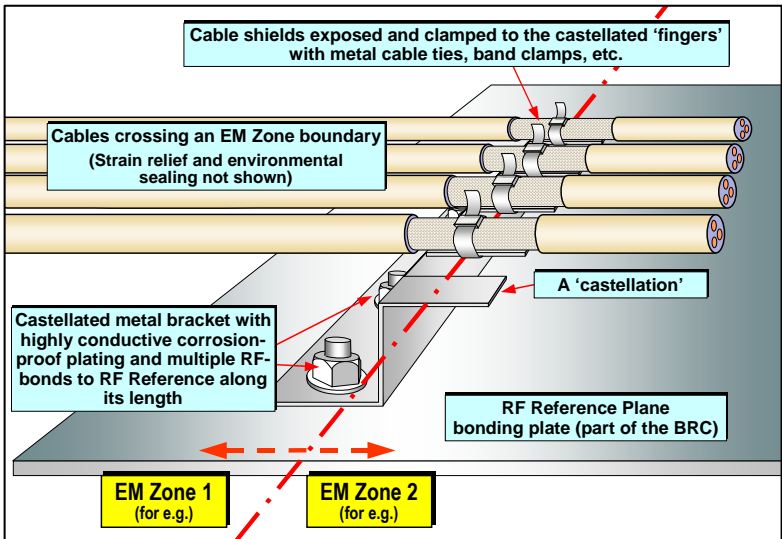

Figure 43 Easily bonding multiple cable shields to an RF Reference (b)



Another method of mass-terminating cable shields is shown in Figure 43. Like Figure 42, this method can be easily adapted to suit a variety of situations. The bracket and its discrete fixings adds some inductance to the RF-bond, so it is not quite as good as the method of Figure 42, in which the lower piece of conductive gasket makes a continuous RF-bond to the highly-conductive surface of the bonding plate.

5.7.7 RF-bonding cable shields using connectors

External cables entering an EM Zone must have their shields RF-bonded to

the zone's BRC at the point where cross, see 5.7.6. This applies even where the shield is also be bonded to the same RF Reference at another place – as it usually will be – for instance at an item of equipment.

An obvious way to bond a shield to the RF Reference is with a shield-bonding connector, such as the types shown in Figure 44 (a D-type) and Figure 47 (a bayonet-locking circular connector), with the chassis-mounted mating connectors themselves bonded metal-to-metal to the bonding plate in the BRC.

Figure 44 Example of 360° termination of cable shield in a D-Type connector backshell

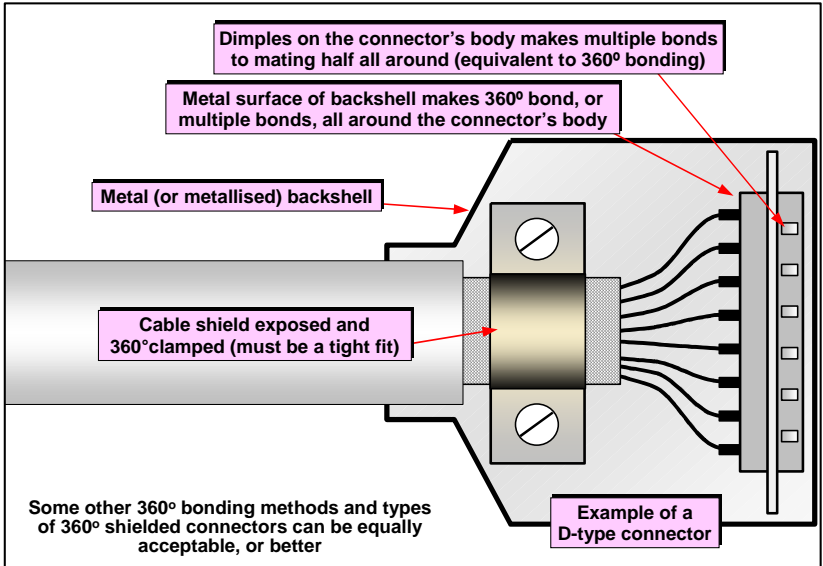

The D-type in Figure 44 shows the cable shield bonded using a saddleclamp, which does not really provide a 360° shield termination but nevertheless is often an acceptable alternative. Some D-types require the assembler to make a pigtail from the braid or the drain wire of a foil-wrapped shield, and trap it under a spring clip or screw head or solder it to

the body of the connector, like the connector shown in Figure 45. These types all provide noticeably inferior SE to the saddleclamp method shown in Figure 44, even though they are often more costly, have solid metal backshells, and/or advertised as being military-standard.

Figure 45 Example of a D-type with poor EMC performance

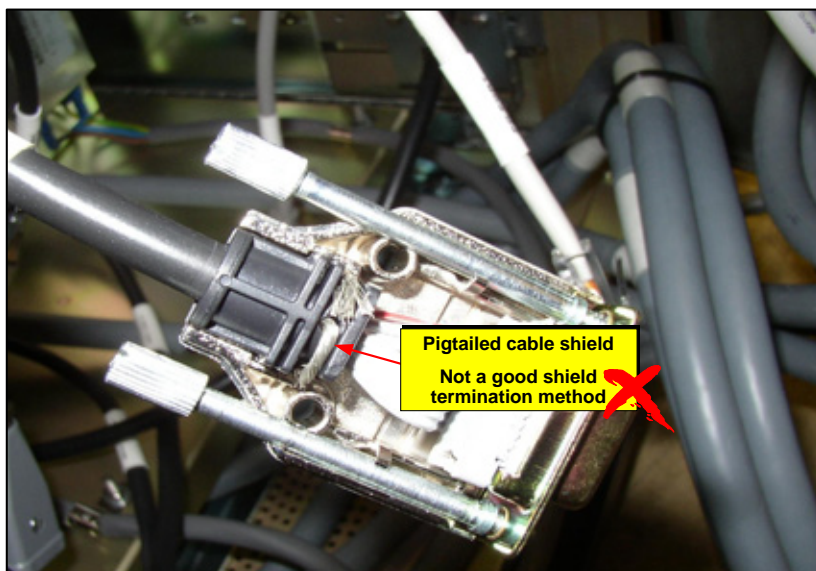

D-type backshells are also available that provide a proper 360° shield termination, for example with a semicircular conductive gasket in each half of their backshell, and these are generally preferred to the type shown in Figure 44. Many shielded D-type connector backshells do not provide a strain relief clamp for the cable jacket. In such situations, where the very best EMC performance is not required, it is usual to

fold the shield back over the outer jacket and clamp both the shield and jacket at the same time. But this makes the EMC performance depend greatly on workmanship, so where the best EMC performance is required as well as strain relief, a D-Type (or any other type of connector) should provide 360° bonding of the *undisturbed* shield – plus a strain relief clamp for the cable's overall jacket.

Some connector manufacturers offer shielding backshell systems for D-Type and other multiway rectangular connectors that combine both shield-bonding and strain relief functions in a crimp accessory that attaches a metal

flange to the cable – the flange being clamped by the backshell when the connector is finally assembled, as shown in Figure 46.

Figure 46 Example of a crimp ferrule system that provides 360° shield bonding, strain relief and easy assembly

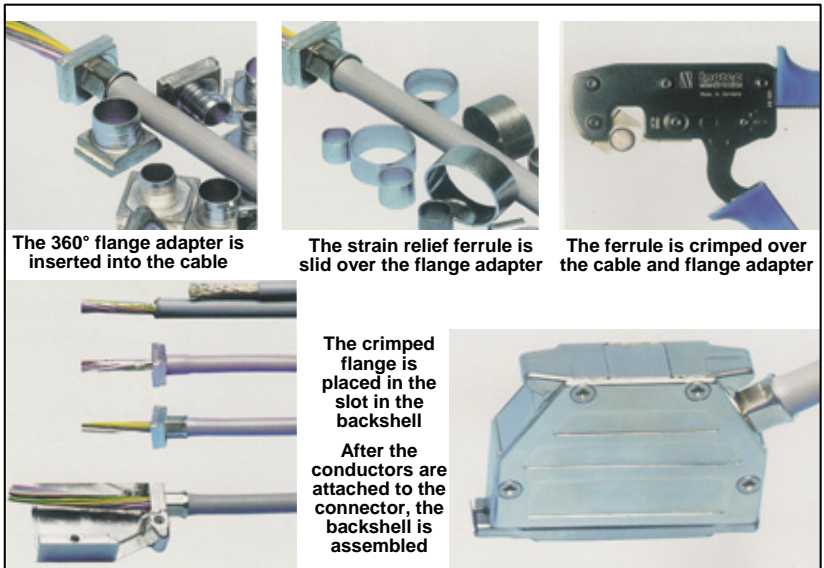

Shielded industrial connectors are available in round and rectangular styles that will take a very large number of signal pins, and carry power up to high currents. Figure 47 shows a cross-section of a circular connector that achieves a very high quality of 360° bond between cable shield and connector body, and also provides a strain relief and environmental seal.

Many other types of connector and shield termination exist, but only those

that make a 360° electrical bond between the cable's shield, the connector's backshell, and the mating connector's backshell (or the mounting panel of the mating connector) work well for EMC. Any connector bonding technique that involves disturbing the lay of the foil or braid of the cable shield, or extending it with wires (see 'pigtailed' in 5.7.8) will compromise the shielding performance of the cable and/or the connector.

Figure 47 Example of 360° cable shield termination in a shielded circular bayonet-locking connector

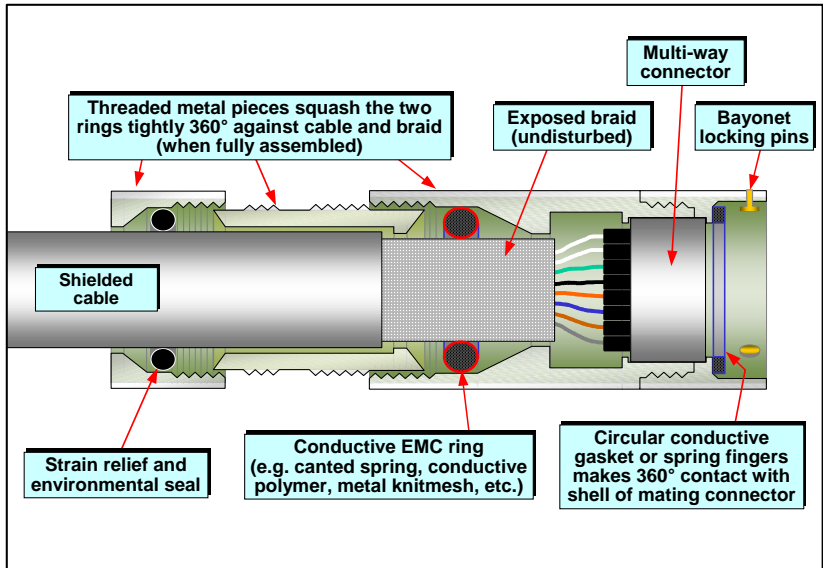

5.7.8 Terminating cable shields using 'pigtailed' – making the best of a poor EMC technique

It has been common practice for decades to bond cable shields using short lengths of twisted braid, or the drain wires in foil-shielded cables, or by soldering a wire to either of these to reach an RF Reference. These lengths of braid or wire are known as 'pigtailed' (or just 'tails'), and using them is generally now a very bad EMC practice that effectively ruins the shielding performance of the cable. However, pigtailed may still be useful when the cable shield is only required for low-level signals (<5V pk-pk) at frequencies below 100kHz.

The author has measured emissions from industrial cabinets that failed the

radiated tests around 70MHz because a single cable from the volt-free contacts of a PLC had a 25mm long pigtail to the RF Reference (the cabinet's backplate in that case). Replacing that very short pigtail with a metal saddleclamp that pressed the shield against the backplate reduced the emissions around 70MHz by over 20dB and the test was passed.

Pigtailed of about 30mm long are long enough to completely ruin the cable's shielding effectiveness (SE) above 1MHz, as shown by Figure 48 (from Figure 27 of [67]). Longer pigtailed, even if they are green/yellow insulated or even braid straps, will worsen SE even more. Also, the bundling of all of the excess lengths of unshielded conductors in the plastic trunking helps ensure a great deal of undesirable crosstalk between the signals on those wires and

other cables – quite possibly what the cable shielding was supposed to be preventing in the first place.

Figure 48 Effect of pigtail on the Z_T of a 25-way subminiature D-type connector

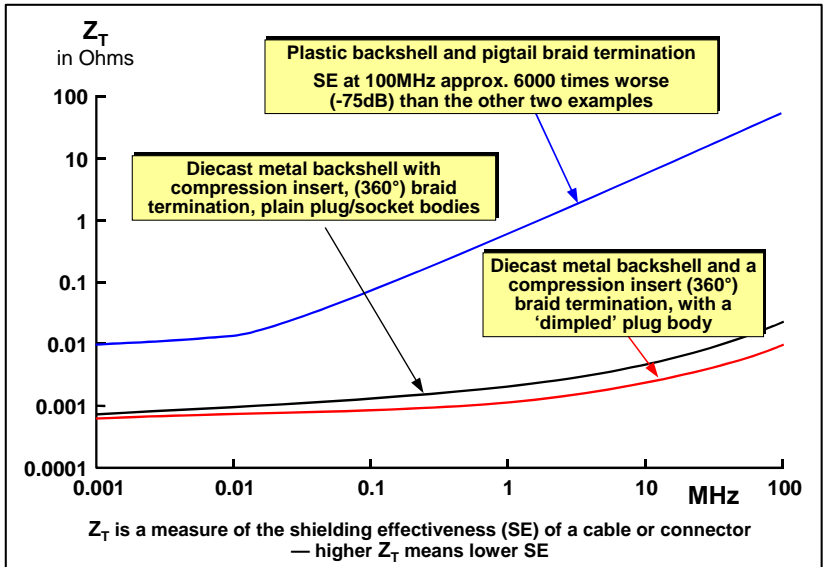

Sometimes all that is needed is an average level of SE up to about 100kHz, for instance to reduce the coupling of 50/60Hz electric and magnetic fields from mains power cables and devices into sensitive transducer signals such as those from thermocouples, strain gauges and the like. Also, variable-speed motor drives and other switch-mode power converters rated at 1kW or more create high levels of electric and magnetic fields below 1MHz, so in some cases shielding may only be required for frequencies below 1MHz. And where unshielded terminals such as DIN-rail mounted ones are used without a shield (see 5.12) at the EM Zone boundary, it

may prove difficult to achieve a good SE at frequencies much above 1MHz in any case.

Figure 49 shows how to use pigtails effectively, using the example of DIN-rail terminals but applicable to any unshielded screw-terminals. To get the best EM performance from a pigtail, the exposed conductors and the pigtail from a cable should be as short as is possible, consistent with the practical needs of assembly (say, around 30 mm), and where possible they should be kept close together by interleaving the shield bonding terminals with the signal terminals as shown in Figure 49. But

remember that pigtailed shields are never going to be much use for EMC

above a few hundred kHz, maybe up to 1MHz.

Figure 49 Making the best of a poor EMC technique – using pigtails at a terminal block

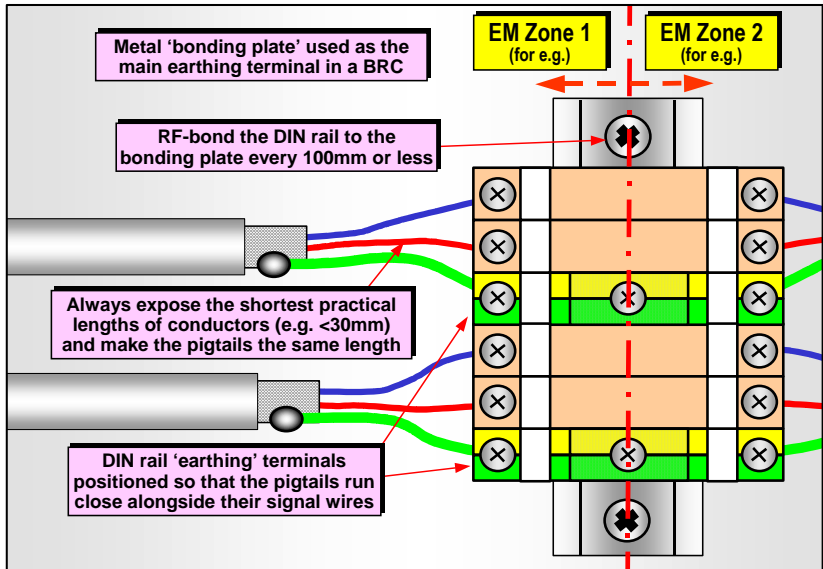

When using DIN-rail terminals, the 'earth' or chassis terminals (usually coloured half in green and half in yellow) connect to the metal DIN-rail, and the DIN-rail is in turn fixed to the bonding plate. Where the DIN-rail's fixings are some distance from the terminals the pigtailed are connected to, they effectively add to the length of the pigtail and worsen EMC performance. Ideally, the DIN-rails would be RF-bonded metal-to-metal by a fixing screw pressing highly conductive metal surfaces together (see Figure 29) at every shield bonding wire terminal. At least, many more RF-bonds are required along the length of the DIN-

rail than are needed for mechanical fixing. It is recommended that, in general, these RF-bonds should never be more than 100mm apart, and they may need to be closer.

Placing shield-bonding terminals (usually coloured green/yellow to indicate they are bonded to the DIN-rail and so are at 'earth' potential) either side of the signal/power terminals also helps provide a little shielding for them, although this cannot be expected to have any significant effect above about 10MHz. On *no account* should the green/yellow terminals used for bonding

cable shields ever be grouped together at one end of a DIN-rail, for 'neatness'.

The RF performance of pigtailed cables can be usefully improved by using two pigtailed cables for each shielded cable. They should be soldered to either side of the cable, and connect to terminals either side of those used by the cable's conductors. Above about 10MHz this method still provides far inferior EMC performance to a saddleclamp or P-clip.

A good alternative to pigtailed cables is to use saddleclamps or P-clips to RF-bond the cable shields close to the unshielded screw-terminals, as shown in the photograph in Figure 50. The minimum length of conductors should be exposed, all the same length, as short as possible and routed as close as possible to the bonding plate (RF Reference).

Solid metal, or overall metal-plated P-clips, will be better than the partially-plated type shown inset in Figure 50.

Figure 50 Example of replacing pigtailed cables with P-clips

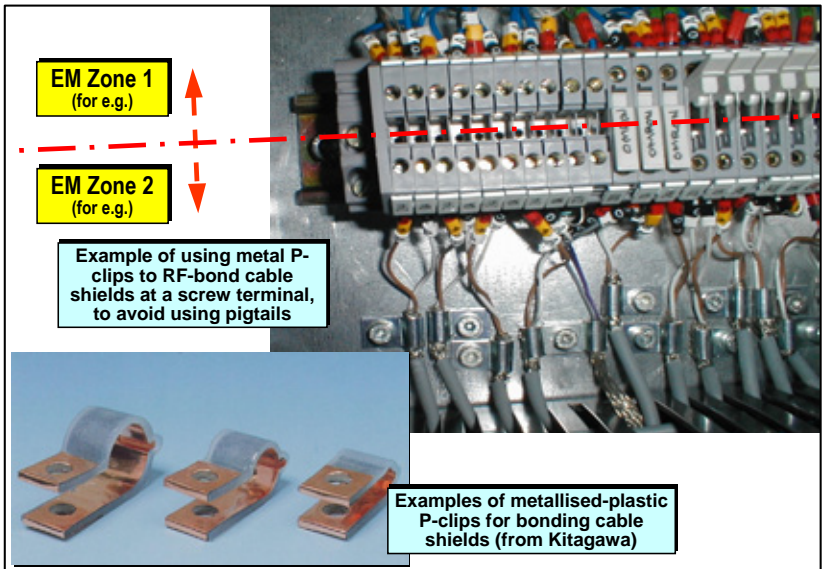

Figure 50 shows DIN-rail mounted terminals, but they could instead be screw or solder terminals of any type. Using unshielded terminals or connectors in any shielded cable system will of course dramatically reduce the SE achieved by the cable overall, unless

they are fitted inside a shielded terminal box. The best type of shield bond to use with a shielded terminal or junction box is the EMC gland, see Figure 41, or a shielded connector.

5.7.9 Capacitive and hybrid shield bonding

If, for some reason, bonding the shield at both ends is impractical, it may prove acceptable to connect a short-leaded ceramic capacitor from one end of the of the cable's shield to its local RF Reference (instead of directly bonding it 360° metal-to-metal, or using a pigtail). This method is sometimes called hybrid shield bonding, because one end has a direct bond to its local RF Reference, while the other has a capacitive bond.

Where *both* ends of a shield use capacitors in series with their shield terminations, this is called capacitive shield bonding.

The frequencies and frequency ranges over which capacitive and hybrid bonding are effective depend upon the types of capacitors used, and their values. The lengths of the capacitors' leads and any wires or conductors attached to them should generally be minimised.

Shield-bonding capacitors should be rated for the voltages they have to withstand, and cables longer than about 10 metres should also be rated to withstand overvoltage surges and transients of at least 500V, maybe as much as 10kV, depending on the cable length, cable route, the meshing used in the of the installation (see 5.5) and the lightning exposure of the site (see 5.13).

These surges are typically caused by lightning electromagnetic pulse (LEMP) and/or by induction from nearby mains cables or lightning conductors carrying lightning surge currents. There may also be other sources of surge or transient overvoltages in some types of installation, such as large AC or DC

motors controlled by electromechanical contactors, capacitor banks (e.g. for power factor correction), or superconducting magnets, see 5.13.5.

Where safety is a concern, the capacitors used may need to be safety-rated. In such cases it is recommended that they are purchased as safety-approved components, and their approval certificates are obtained and checked with their issuing bodies to make sure they are not forgeries.

Unfortunately, without using special (and expensive) annular capacitors it is difficult to make capacitive shield bonding work well at the higher frequencies being used by modern electronic equipment, or work well over a wide range of frequencies. So hybrid or capacitive shield bonding is a technique best kept in reserve to deal with special situations, such as where 360° bonding at both ends is not possible for some reason, or proves to cause problems that cannot easily be solved using the methods in 5.8.

However, when using single capacitors as terminators, the cable's best SE only occurs over a fairly narrow range of frequencies.

Where a cable has been assembled using 360° shield bonding or pigtails at both ends, on-site replacement of its shield bonds by capacitors is not too difficult, and removing one or both shield bonds (should it prove necessary) is very easy. However, where a cable has been assembled with its shield bonded at only one end, or at neither end – attempting to fit capacitors or 360° shield bonds to solve EMC problems on-site or during compliance testing can be very difficult and time-consuming.

So it is best to standardise on 360° bonding at both ends of cables, modifying them if it proves necessary. However, if the good EMC engineering practices described in this Guide are followed, 360° bonding at both ends will generally give the very best EMC performance without harming any signals due to 'ground loops' (see 5.8).

5.7.10 Some additional shield bonding issues

All cable shield bonding methods (other than pigtailed) should make a tight fit all around the periphery of their cable's shield (but without damaging the cable), and this tight fit must not become loose with age, wear and tear. Braid shielded cables are the easiest to RF-bond, and it is always best not to disturb the lay of a cables' shield when 360° bonding to it.

Spiral-wrapped foil-shielded cables are not so easy to RF-bond to. Their foil is an insulating plastic film that is metallised on one side only, so it is important to make sure that it is the *metal* surface of the foil that makes a 360° contact with the connector backshell or other shield bonding method. This is not too difficult where it is the outside surface of the foil that is metallised.

But where the internal surface of the foil is metallised, the foil will need to be folded back and this cannot be done without cutting it – limiting the use of such cables to applications in which it is acceptable to stop the cable shield at that point (e.g. when entering a well-shielded EM Zone or equipment enclosure). Unfortunately, it is very difficult to fold back a spiral-wrapped foil to expose its metal surface to obtain a reliable 360° bond, so the EMC

performance of such shield bonds is very susceptible to quality of workmanship, and often degrade quite rapidly over a period of a few years.

It has been common practice for many years to use the drain wire as the sole means of bonding foil-shielded cables, but this creates a 'pigtail' (see 5.7.8) and ruins the EM performance of the cable above a few hundred kHz. So it is important for any drain wires in the foil-shielded cable to be RF-bonded along with the metallised surface of the foil. Where a foil shielded cable is a little loose in a shield clamp, it might be possible to wrap the drain wire over the exposed metallised foil surface a few times to make a tighter and more reliable clamp.

Another problem with spiral-wrapped foil-shielded cables is that their aluminium metallisation is very thin, and exposure to polluted atmospheres can cause it to oxidise very quickly, whereupon it turns to a grey insulating dust and ruins the shielding performance of the cable. This can also occur at the cable's ends, and even to metal-plated plastic connectors, where the shields are terminated in connectors or to equipment.

Because of the above difficulties associated with spiral-wrapped foil shields, braid shielded cables are generally preferred to spiral-wrapped foil-shielded types. However, a few cable manufacturers make foil-shielded cables that are not spiral wrapped (e.g. Belden 'Z-Fold') and may also use thicker metallisation, and these can overcome some of the problems that occur with wrapped-foils.

5.8 The benefits of 'earth loops' ('ground loops')

Some of the good EMC engineering practices described in Section 4, and many of those described in Section 5, result in the creation of 'ground loops' (also called 'hum loops', 'earth loops', etc.). For example, an RF Reference is essential for the effectiveness of EM mitigation methods such as zoning, filtering, shielding and surge suppression, and they necessarily create very many small ground loops. Also, bonding cable shields at both ends so that shielded cables actually provide useful shielding (see 5.7.6) creates ground loops.

So it is important to discuss why 'ground loops' are not the problem that almost everyone seems to think they are – why they are actually good for EMC – and what to do with equipment designed in such a way that it has a problem with ground loops.

Several decades ago, most of the interference problems in installations were at 50Hz and it was possible to control circulating currents ('earth loops') using single-point earthing techniques. This encouraged the design of cheaper electronics using poor circuit design techniques that relied upon single-point earthing installations so as not to suffer from 50Hz noise problems.

Better electronic design techniques were available that made the design of the installation's earth structure irrelevant, but since they added a few percent to the cost of the parts – manufacturers used the cheaper, poorer design techniques to make more profit. This was at the expense of adding headaches for users, who might have to

employ experts for several days (or more) to hunt down the 'rogue' ground loops in their installations and eliminate them.

Since most customers only considered the 'sticker price' of the equipment they bought, and didn't ask about the difficulty and cost of getting them to work as required in their installation, the cheap electronic design that needed single-point earthing became the usual practice.

Eventually, the idea of avoiding ground loops to avoid problems became so entrenched that it became a standard practice that nobody questioned, indeed it sometimes seems to have become almost heretical to question it. In fact, it only came about because of the use of cheap and nasty electronic design techniques by equipment manufacturers to maximise their profits with no care at all for the customers' overall costs of ownership.

(The author is well qualified to discuss this issue, because decades ago he was one of those electronic designers employing the cheap and nasty design techniques that relied upon the user achieving single-point earthing, despite the huge practical difficulties that this quite clearly created for customers with very complex professional audio installations with very high signal-to-noise ratios. His excuse is that he was 'just following orders' at that time, and had not yet understood how to design circuits correctly for use in installations.)

These days the normal environment for equipment is highly polluted with frequencies from DC to thousands of MHz, and getting more polluted every day due to technological progress. The signals routinely used by electronic

communications in cables now regularly extend to 30MHz and above. At the frequencies in typical use these days the stray ('parasitic') mutual inductances and capacitances in systems and installations create circulating RF currents that flow through air or insulation and can cause interference, and these high frequencies cannot be controlled by single-point earthing techniques.

One reason why single-point earthing cannot possibly work at RF is the inherent inductance of all conductors, which is about $1\mu\text{H}$ per metre (very large cross-sectional area wires, tapes or straps might approach as little as $0.5\mu\text{H}$ per metre). This results in a series impedance of up to $2\pi f$ Ω /metre, where f is given in MHz. So for example at 10MHz a 10m long 4mm diameter earth conductor has an impedance of about 600Ω – clearly incapable of 'earthing' currents or voltages at that (fairly low) frequency.

Another reason why single-point earthing cannot possibly work at RF is the accidental antenna behaviour of all conductors, as shown in Figure 7 and discussed in 3.4. Earthing conductors are just accidental antennas, like any other kind of conductor. The electrons flowing in them don't behave differently just because the insulation is coloured green with a yellow spiral stripe!

So single-point earthing is only capable of being effective up to a few kHz, which makes it useless in any system or installation where frequencies of MHz need to be controlled by the installation's design. To create an RF Reference above this frequency, there is no alternative to creating a mesh of ground loops, as described in 5.5.

Mesh-bonding, and terminating cable shields at both ends, allows stray currents to circulate as they will in the RF Reference and cable shields. The benefit of this is that because RF currents flow in the path of least impedance, they naturally take the path with the smallest loop area (i.e. the lowest inductive), which allows us to control where they flow. This is simply not possible when using 'traditional' single-point earthing techniques. These mesh-bonding techniques can be developed to achieve as much control as is necessary for even extreme EM environments.

The negative aspect of this approach is that stray currents at the frequency of the electrical power supply and its harmonics are also allowed to flow where they will, and they will generally split along multiple paths in the inverse ratio to those paths' *resistances*. The higher the degree of meshing, and the smaller the mesh size, the smaller each of the individual currents will be. By comparison, single-point earthing constrained them to follow a single conductor, back to (usually) the main earthing terminal, sometimes called a 'star point'.

However, equipment that has been properly designed for use in systems and installations will use input and output drivers that happily resist the CM effects of stray power frequency (and its harmonics) current flowing in meshed systems. 5.6 describes some methods for dealing with equipment that has not been properly designed for systems and installations, for example consumer products.

Data centres use servers and other equipment such as RAID arrays, all

designed to provide the highest possible computing/storage performance at the very lowest cost. They are not properly designed for use in systems and installations, because this increases their selling price and makes less well-designed equipment appear to be more price-competitive. As a result, computer rooms and data centres have to use mesh-bonded RF References that achieve very low impedance up to at least 30MHz (see 5.5.4 and Figure 25). The purchasers of the servers, so pleased to have bought them at the lowest price, are generally not aware that this low price is achieved at the additional cost to them of a more expensive RF Reference construction.

There is a common fallacy that stray currents in cable shields induce noise into the signals contained within those shields, and it has even been blessed with a name and an acronym: SCIN (shield current induced noise). The author and colleagues have tested this with shield currents high enough to melt regular PVC insulation, at frequencies up to 100kHz, with good quality twisted-pair cables and also with straight multiconductor cables deliberately constructed to have a high degree of unbalance between a signal's send and its return, and found that it is simply not true – see [54] [55] and [56].

What *really* happens is that stray currents in an installation give rise to voltage differences between items of equipment that are interconnected by signal, control or data cables, and it is these 'ground noise' voltages that cause the apparent noise in the signal, and they also cause the stray currents in the shield (that are then mistakenly blamed as the *cause* of the noise).

When we realise this fact, which can easily be tested with commonplace electrical test equipment, we begin to understand that the higher the degree of meshing, and the lower the impedance of the RF Reference, the lower the voltage differences will be between the grounds of items of interconnected equipment, that are the real cause of so-called 'ground loop' noise. The currents that flow in cable shields as a result of them being bonded at both ends, helps reduce the noise by improving the mesh-bonding of the RF Reference.

Since 1990, the author has had a great deal of experience with testing the RF immunity of electronic equipment designed to use single-ended shield termination (for use with single-point earthing systems), to the immunity standards listed under the EMC Directive. Such equipment always failed the RF immunity tests unless 'proper' both-ends shield bonding was used, as described in 5.7.6. As more equipment manufacturers are taking the trouble to actually comply with the EMC Directive, they are finding that they have to use modern design techniques that no longer have to rely upon single-point earthing in their installations.

Equipment imported from countries outside Europe, where such immunity performance is not a legal requirement (e.g. USA, Canada, and most of the other countries in the world) is of course CE-marked, but in some industries it is clear that most such equipment has never been tested for RF immunity, and when used in systems and installations it can suffer noise problems that its manufacturers claim is caused by 'ground loops' in the installation but in fact are caused by their adherence to

long-outmoded circuit design practices that are not in the best interests of their customers.

It is good EMC engineering practice to ask suppliers appropriate questions about how their equipment should be 'earthed' and any cable shields terminated, before purchase, and only buy equipment that does not suffer from ground loop problems when used with RF References and properly shielded cabling (i.e. shields bonded at both ends). It is also good EMC engineering practice (see 2.3.4) to request evidence of compliance with both emissions and immunity tests listed under the EMC Directive. Suppliers that decline to provide such information to a potential customer (for example in the form of test reports) or who promise information that never arrives, often prove not to understand how to do EMC engineering for systems and installations, so should generally be avoided.

Where 'single-point earthed' equipment must be used for some reason, 'ground loop' problems can sometimes arise where installations must use an RF Reference (see 5.5) or effective cable shielding (see 5.7.6).

But these so-called 'ground-loop' problems can usually be resolved easily and quickly using some of the wide variety of digital and analogue galvanic isolation devices available for this purpose from many suppliers. Galvanic isolation (see 4.3) is especially recommended because it also help protect against surge overvoltages – which are a particular problem for single-point earthed systems, see [56].

Suitable devices range from isolating transformers (e.g. audio 'balancing' transformers; 'pulse transformers' used

for Ethernet) to devices employing optical or capacitive isolation. Many suppliers are now offering Bluetooth and similar wireless modules that plug into cable sockets to replace them with wireless data links.

Metal-free fibre-optic communications are the best for EMC, and are now available in a huge range of types, from low-cost plug-in replacements for RS232 cables, through DC-2GHz 'transparent' links that can carry any kind of signal or data, to 40GHz links such as are used for the national telecommunications backbone.

If none of these methods are employed, a PEC might be sufficient to reduce the so-called 'ground loop' noises to negligible levels (see 5.9). If this is impractical, see 5.7.9

5.9 Parallel Earth Conductors (PECs)

5.9.1 PECs as elements of the MESH-CBN

When using mesh-bonding, if equipment has difficulties in handling the resulting stray power-frequency (and its harmonic) currents flowing in its input or output signal, control or data cables, and if the techniques mentioned at the end of 5.8 have not been used for some reason, the solution is generally to use a Parallel Earth Conductor (PEC).

A PEC must have a very low resistance when compared with the resistance of the cable shield, and it must be RF-bonded directly to the equipment frame/chassis/enclosure at both ends (see 5.7), and the cable concerned must be strapped to it along its entire length. The ratio of the resistance of the shield

to that of the PEC is the ratio by which the PEC will reduce shield currents up to about 1kHz. For example, a typical 100m long shielded cable with a small diameter could have a shield resistance of about 2Ω , and a 6mm diameter copper wire PEC would reduce its shield current to about 3% (a reduction of about 30dB).

This Guide uses the term 'Parallel Earth Conductor', PEC, because this is the term used in IEC 61000-5-2 [43], but it is *not* a very good term because what it describes has everything to do with bonding, but might have nothing at all to do with protective safety earthing. 'Parallel Bonding Conductor' (PBC) would have been a much better term, or 'Bypass Conductor' – a term that is used in some other installation standards when they mean a PEC.

Currents leak from all cables (although higher-quality types leak less), giving rise to CM currents and voltages in the CBN and equipment chassis/frames/enclosures, which 'drive' the cables as accidental antennas (see 3.4). It was mentioned in 4.8.2 and 5.5 that it is good EMC practice to route all cables very close to parts of their MESH-CBN all along their route, because this provides a much lower loop area for these CM currents, hence a lower-impedance path for them and a reduction in the cable's emitting/receiving efficiency as accidental antennas.

A PEC is part of the MESH-CBN – or another way of looking at it is that parts of the MESH-CBN can be used as PECs if cables are routed in intimate proximity to them, Either way – as well as the

benefits above for reducing shield currents – they also improve overall EMC performance. Where the CBN is used as the RF Reference, as it generally is, then the PEC is also part of the RF Reference. Figure 51 shows some examples of using different conductors as PECs – the lower their number, the better they are for higher frequency EMC.

Where a PEC is used just to divert 50Hz currents away from a cable shield, to reduce noise at 50Hz and its first few harmonics, a long wire PEC is perfectly adequate.

To comply with Health and Safety regulations, an installation will usually have its CBN connected to its earth electrodes, and be robust enough to withstand all foreseeable electrical faults without suffering overheating or any other kind of damage. In such installations, any additional conductors such as cable shields that could carry earth/ground fault currents do not need to be rated to carry fault currents – they are protected by the existing earth/ground structure. Even a cable shield having a cross-sectional area of 1 square millimetre could be draped all through such an installation, connected to equipment chassis at each end, without suffering damage due to faults in the power distribution.

However, it is probably wise not to rely on this when using single-point earthing, because it is vulnerable to corrosion and single faults. There would be no such concerns when using a heavily mesh-bonded CBN.

Figure 51 Types of PECs

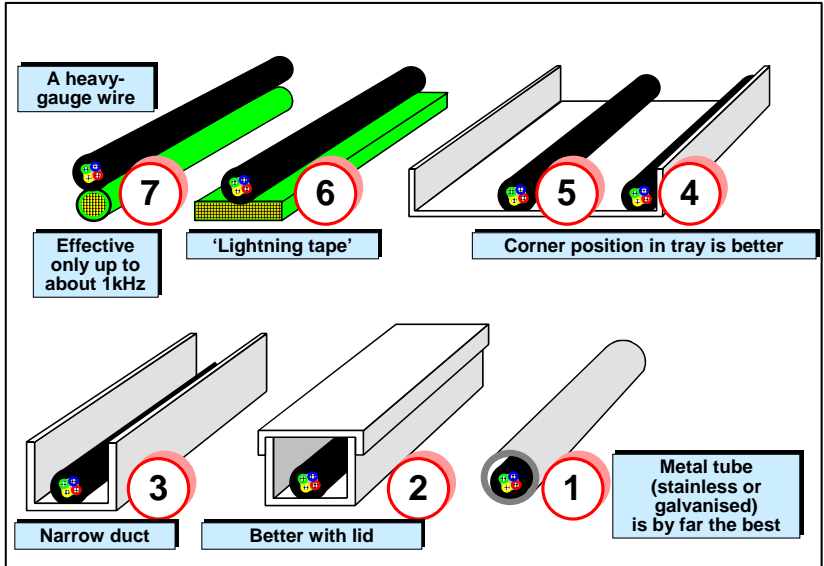

In legacy installations where the impedances in the safety earthing/bonding structure may be high, and/or where the degree of meshing of the CBN is low, PECs should be rated to carry high currents during fault conditions.

But where installations have very high levels of magnetic fields, for instance large power generating plant, additional conductors (such as cable shields) that do not closely follow the same route as elements of the CBN will experience induced circulating currents that could cause them to overheat. This is one of the reasons why 4.8.2 recommended routing all cables very close to the conductors of their CBN or MESH-CBN all along their routes – to minimise loop areas.

Any 'natural' metalwork forming part of the MESH-CBN can be used as a PEC, for example steel girders, cable support trays, ducts, etc., but don't forget they must be RF-bonded at all joints and at both ends to the equipment frames/chassis/cabinets/etc. as described in 5.5, with the spacing between RF-bonds in metal structures that act as PECs being no greater than $3/f_{\max}$ metres (f_{\max} in MHz). See Figure 34 for a solution for terminating the ends of solid conduit.

It is important to remember that when using existing so-called 'natural' metalwork and/or cable armour as part of a CBN, or as a PEC, it must be managed to ensure that all joints and connections remain bonded over the lifecycle, and that no electrician disconnects any part (e.g. by adding a

junction box to an armoured cable) during any modifications or additions to the system or installation. Cable support structures and armour are usually assumed to be simply for mechanical protection purposes, so when they are used to improve EMC performance, any/all work that could affect them must be supervised appropriately.

Figure 52 shows some examples of cable routes along a steel I-beam girder, rating each route by its performance as a PEC at various frequencies. Figure 53 shows an example where the type of metal structure used as a PEC changes along the cable's route, rating the various alternatives as before.

Figure 52 Example of using a steel girder as a PEC

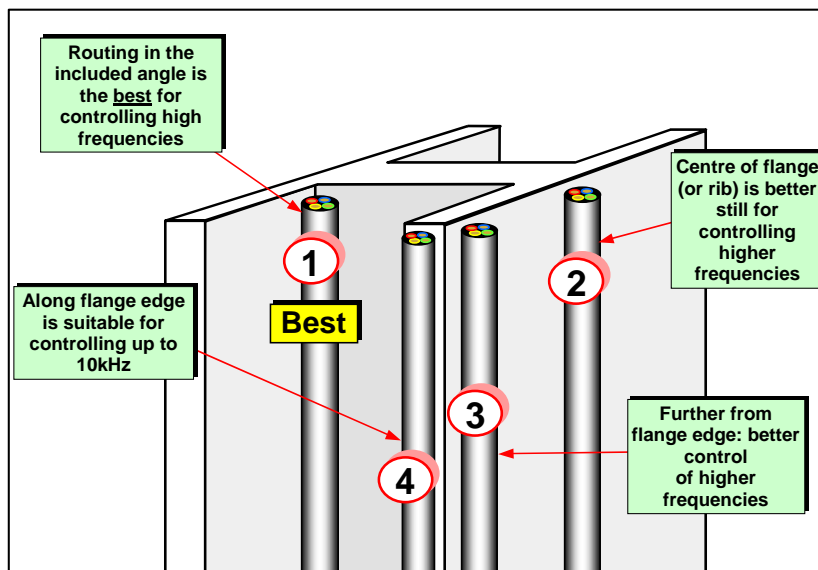

Any cable armour should be used as a PEC, but for normal types (e.g. steel wire armoured, SWA) its performance at frequencies above a few kHz can be hard to predict. Some cables are available with armour that combines mechanical strength with a braid shield, a combination that can almost be as good as metal tube (No. 1 in Figure 51).

Figure 54 shows examples of armoured cables leaving/joining a cable tray PEC, RF-bonding their armour at the point of leaving/joining the tray. Where an unarmoured cable has a braided shield with a large copper cross-sectional area, it might be practical to use the braid as a PEC as if it was armour.

Figure 53 Running cables along PECs

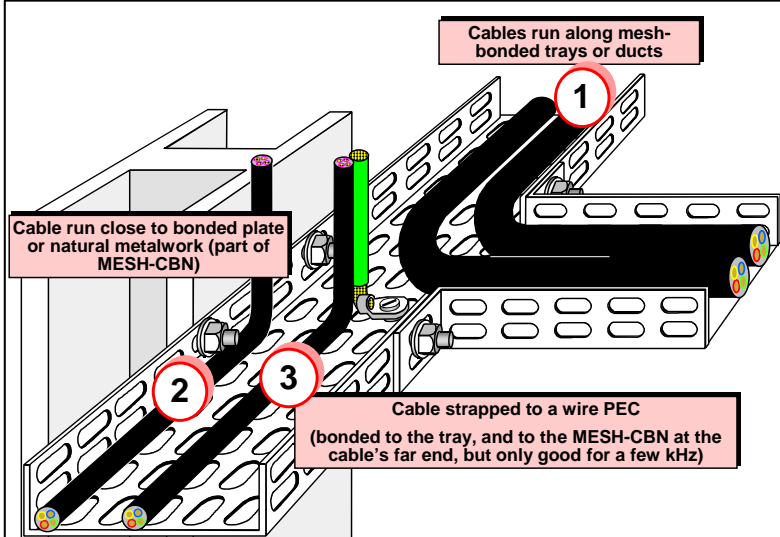
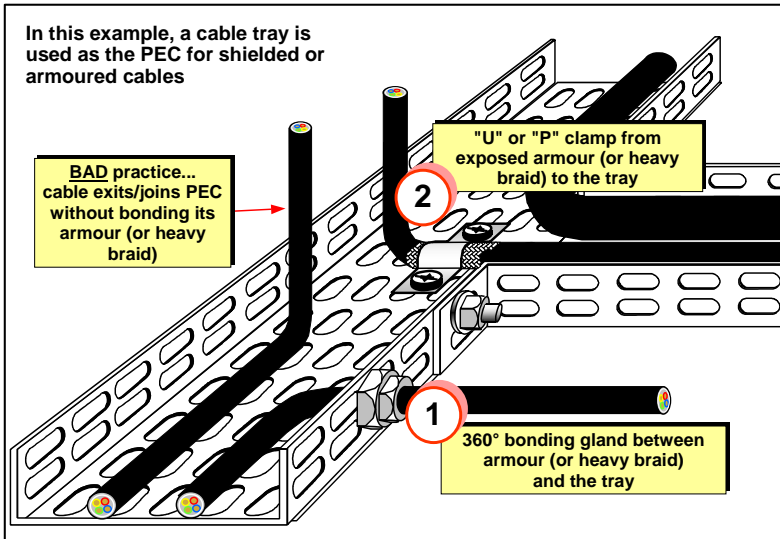

Figure 54 Armoured cables leaving or joining a tray PEC



The best PECs for control of high-frequency EMC have no slots or gaps at all (even at their joints). Figure 55 shows examples of various holes and slots in cable trays, with comments about their

effect on EMC, and Figure 56 shows an example of good EMC joint in a proprietary cable management tray system.

Figure 55 Holes and slots in cable trays and ducts used as PECs

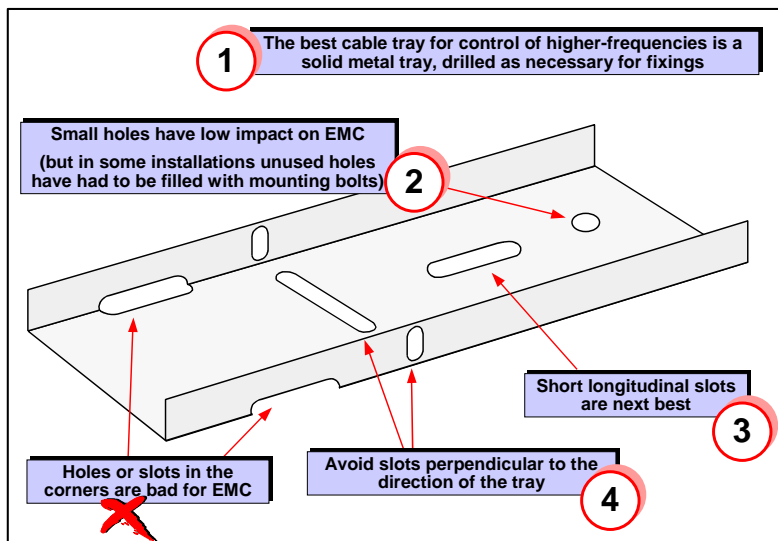

All PECs should be mesh-bonded to their MESH-CBN wherever practical, not just at both ends, using RF-bonding techniques. This helps reduce the impedance of the MESH-CBN and make it a better RF Reference.

5.9.2 Sizes of cable bundles

Cables routed inside metal conduit or covered ducts or trays, can fill the entire volume available (subject to segregation by Class, see 4.8) – providing the covers or lids are RF-bonded metal-to-metal to the body of the tray or duct at intervals along their length no further apart than

every $30/f_{\max}$ metres or less (f_{\max} in MHz).

Joints in covers and lids should be overlapped where practical, and RF-bonded together every $3/f_{\max}$ metres or less, along any/all joints and to the equipment chassis/frame/enclosure at both ends, as for any joints in a PEC such as a cable tray. To make assembly easy and quick, it is best to use the same high-surface-conductivity low-corrosion metal, or metal plating, for the ducts or trays and their covers or lids (see 5.7.3) using types of trays or ducts that press their metal surfaces together at the contact points, as discussed in 5.7.1 and shown in Figure 28.

Figure 56 Joints and gaps in cable trays used as PECs

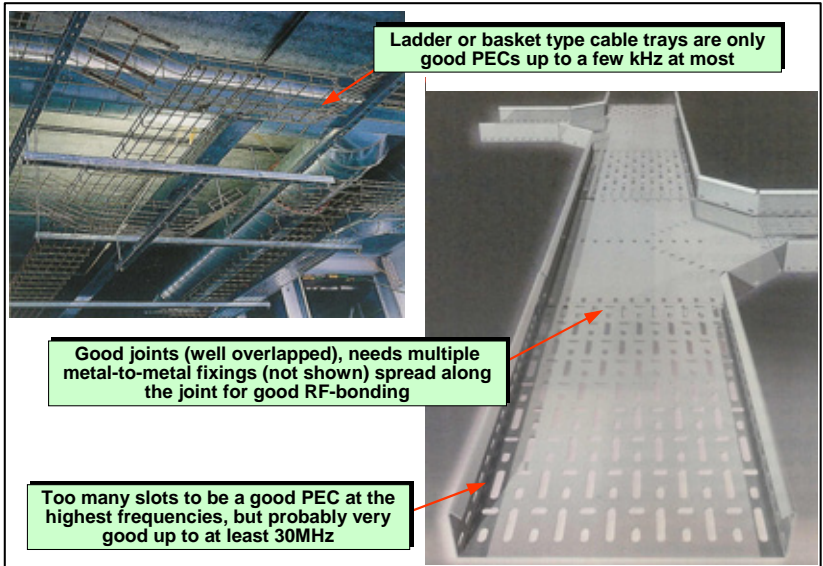

Where metal trays or ducts do not have a metal cover or lid RF-bonded as described above, the cables should not be stacked up too high. In a shallow tray, it is best to have a single layer of cables, all reliably strapped down against the base of the tray, as shown in Figure 57.

In a deep tray or duct, increasing distance from the base degrades EMC performance, so it is once again best to

use a single layer of cables strapped against the base – but it is often acceptable to use two or more layers as long as the maximum height is less than half the metal wall height. This is a very crude guideline, greater accuracy requires calculations or computer simulations of the SE provided by the uncovered tray or duct.

Figure 57 Some examples of cables bundled into trays and ducts

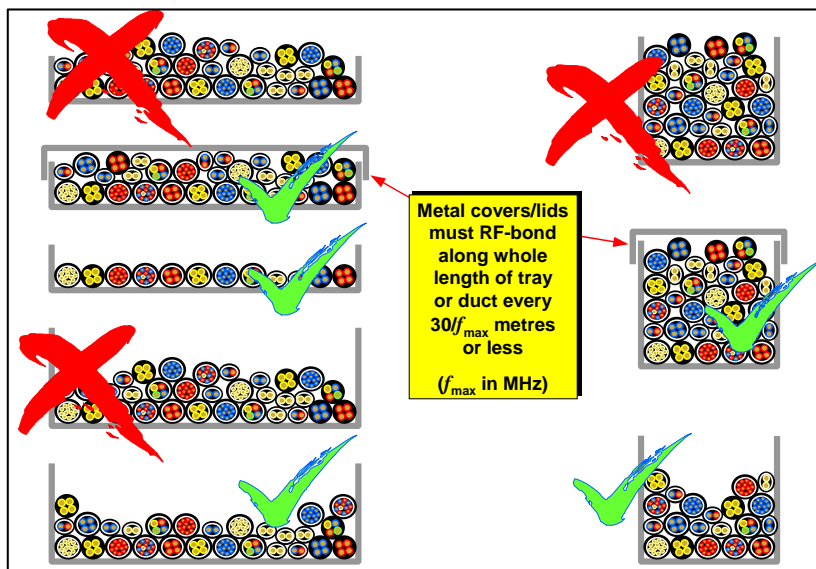

5.9.3 Controlling the CM loop

It was mentioned above that it is good EMC practice to route all cables close to elements of the MESH-CBN (which might be called PECs) (see 4.8.2), preferably an RF Reference (see 5.5.3) along their whole length. One reason is to take advantage of the 'image plane' effect to reduce their efficiencies as accidental antennas. Another is that the nearby metal helps return the CM current that always 'leaks' from cables so that the resulting CM current loop has the smallest area, once again helping reduce the accidental antenna efficiency. However, cables can be very long and even though the area of the CM loop between a cable and its RF Reference is made as small as possible, the longest

dimension is as long as the cable and it will resonate at frequencies at which the length is a whole number of half-wavelengths. $f_{\text{RES}} = 150n/L$ where L is the spacing between two bonds (L in metres gives f_{RES} in MHz) and n is an integer (1, 2, 3, etc.). For example, the CM loop for a 10m long cable routed very close against a sheet metal RF Reference would resonate near to 15MHz, 30MHz, 45MHz, 60MHz, etc.

At resonance, the CM current loop will amplify the RF currents and/or their voltages, making the cable a more effective accidental antenna, possibly increasing emissions and/or worsening immunity.

CM loop resonant frequencies can be increased by exposing and RF-bonding the armour and shields of cables directly

to the RF Reference (MESH-CBN or PEC) at intervals along their length, using one of the direct RF shield-bonding techniques described in 5.7.6 (and not pigtails). The idea is to increase the lowest resonant frequency f_{RES} ($n=1$) so that it is higher than f_{max} .

This technique is not one that anyone ever finds very desirable, but sometimes it is the only way to solve an interference problem without ripping out all the cabling and replacing it with a higher quality type that has less CM leakage (e.g. double-shielded). Protecting the cables at the bonding points, where their outer jackets have been cut away to expose their shields, can be important in some physical or climatic environments.

An alternative to frequent RF-bonding is to dampen down the CM loop's resonances – reducing their 'Q' (their resonant gain) and making them less effective accidental antennas – by fitting ferrite CM suppression chokes to the cables. Whereas the RF-bonding technique only works for shielded cables, this works for all types. The ferrite choke fits around the outside of the cable (or cable bundle), and so acts on the unwanted CM current, and not on the wanted differential-mode (DM) signal, and Figure 58 shows some examples of the kinds of ferrite suppressers available.

Figure 58 Examples of ferrite suppressers for CM cable currents



It may be necessary to use several CM chokes spread along the length of a cable, spaced $<75/f_{\max}$ apart. Larger chokes generally provide more damping, but two or more smaller ones can often be as effective as one large one. The chokes are available with different core materials to suit different frequency ranges, and it is best to choose types where their maximum impedance is achieved near to the resonant frequency to be suppressed.

Clip-on chokes use a split ferrite core in a plastic holder, and can easily be clipped over cables in-situ. EMC engineers visiting sites to solve interference problems always carry a

large range of such chokes with them. Unsplit ferrites chokes cost less than clip-on types, but are more disruptive and time-consuming to fit to an existing installation.

5.10 Choosing and using filters

5.10.1 Choosing filters for electrical power

As any catalogue of filters, and Figure 59 shows, there are a great many types of mains filter, and there are also a great many types of signal filter – so it is important to choose the right ones for your applications.

Figure 59 Some examples of mains filters

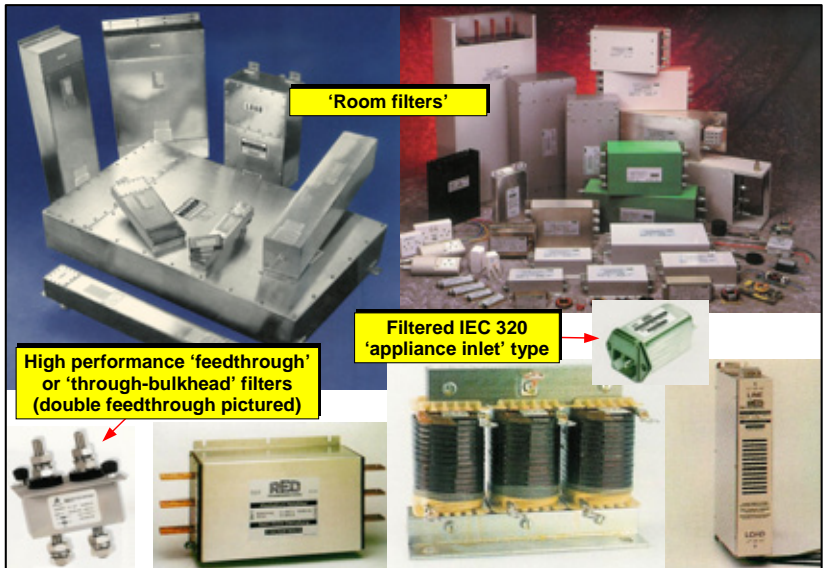

Filters designed for use on 50/60Hz mains supplies can generally be used for filtering electrical power from DC to 400Hz, although their maximum current

and temperature derating curves should be checked with their manufacturers. Filters that provide attenuation at lower-frequencies, carry higher currents, or

achieve higher attenuation, will generally be larger and more expensive. A very crude but often effective measure of a filter is its weight. If comparing two filters with similar specifications and costs, the heavier one will often perform better in real life.

Electrical power distribution networks are not impedance-matched 50Ω systems, and very few electrical loads have a resistive impedance of 50Ω , yet the shortform data published by suppliers and distributors is generally based on testing with 50Ω sources and 50Ω loads, giving results that often bear little relationship to the attenuation they provide in real life.

Good filter manufacturers will provide six sets of attenuation data, all measured using the CISPR17 test method, as graphs covering the whole frequency range of interest, including both the conducted range (down to 150kHz or less) and the radiated frequency range (e.g. up to 1GHz or more):

- Test results with 50Ω source and 50Ω load, known as ‘matched 50/50’ tests.
- Test results with 100Ω source and 0.1Ω load, known as ‘mismatched 100/0.1’ tests.
- Test results with 0.1Ω source and 100Ω load, known as ‘mismatched 0.1/100’ tests.
- All of the above three tests performed in both CM and DM (known as ‘asymmetrical’ and ‘symmetrical’ respectively by filter manufacturers), making six sets of test result graphs in all.

When choosing a mains filter for a system or installation, it is safest to assume that its real-life attenuation at a given frequency will be no better than the worst-case derived from all six of these test results. Figure 60 shows an example based on just three sets of test results from a real filter.

All power filters use inductors and capacitors, and so are resonant circuits that with some values of source and load impedances can produce gain instead of attenuation. The first time this happens to you in real life often comes as something of a shock.

Figure 60 shows that if the filter had been expected to behave according to the usual $50\Omega/50\Omega$ attenuation curves at frequencies around 300kHz, an attenuation of around 15dB would have been anticipated. But in real life, with the usual mismatched source and load, it could instead have given a gain – an actual *amplification* of the noise it was supposed to be attenuating – of up to 20dB.

The filter whose data was used in Figure 60 was a low-cost single-stage mains filter, and such filters when mismatched (that is to say, in most real-life applications) produce gain of up to 20dB, at as frequency that is usually somewhere between 100kHz to 5MHz (it is impossible to be more precise because the range of possible filter designs is very large). Two-stage mains filters might have matched 50/50 graphs much the same as single stage versions, whilst having up to double their size and cost – but their mismatched curves generally reveal much superior attenuations, with resonant peaks generally no worse than 10dB over the frequency range 10 to 300kHz.

Figure 60 Deriving reliable filter attenuation figures from manufacturer's data

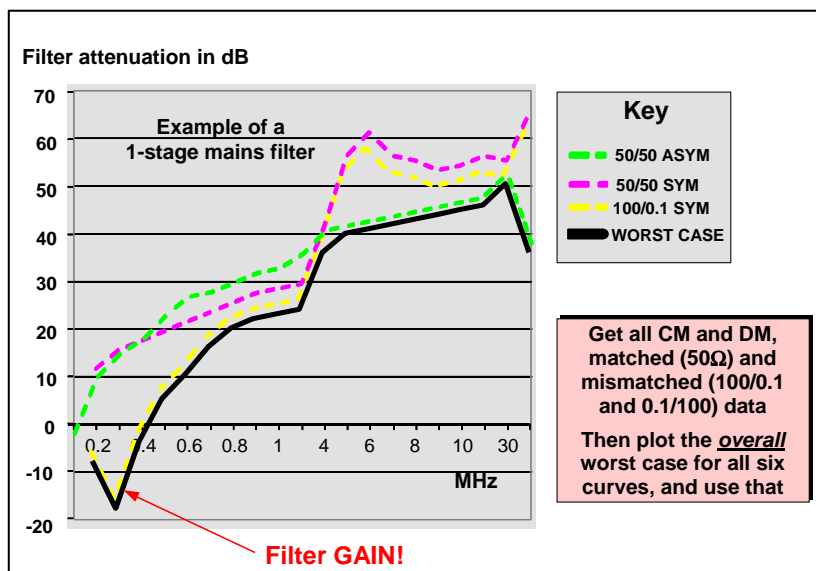

Filters with more stages, even up to seven, are available as standard products from a variety of manufacturers, who are also usually only too pleased to design custom filters for applications of any sort. In general, the higher the number of stages in a filter, the more reliable is its attenuation when it is connected to real-life sources and load impedances.

The attenuation provided by mains filters varies with the supply voltage, load current and their operating temperature [24], so it is best to choose filters that – according to the process described above – have *at least* 10dB more attenuation than appears to be actually needed.

Detailed calculations, or computer simulations, are appropriate techniques

to reduce the risk to costs and timescales of choosing the wrong filters, and/or having to use trial and error. An alternative is to plan for some iteration of the filters during commissioning, leaving enough room for the largest, most costly filter we hope we will not need, and testing the installation to find which filter works best in real life. A good supply of hopefully suitable filters is required, from the lowest-cost to the highest-performance, from several filter manufacturers.

How to do testing for conducted emissions and immunity is described in [40] [41] [32] and [68], but if you do not want to do it yourself, there are many EMC test laboratories [59] with the necessary skills and equipment for on-site testing, and some filter

manufacturers will also be pleased to help.

Filter input and output wires must never come anywhere near each other, as they are always at least one cable Class apart (see 4.8). Cascaded mains filters (connected in series) can interact and make the overall EMC performance worse than that of each filter on its own, as discussed in [69], so if it is necessary to cascade filters on a single cable the additional filter might have to have more stages, and/or be larger with a higher specification, than might seem necessary.

It is also worth noting that the best filters for EMC generally have seamless metal bodies (deep-drawn, or seam-welded) fitted with flanges or other means of directly bonding them metal-to-metal to a local RF Reference at least at two points, see 5.7.5.

Where high levels of attenuation are required, filters suffer from stray induction and radiation between the conductors on their input and output sides. So will generally need to be combined with shielded cables (see 5.11), or closely-spaced meshes or even sheet metal used as shields (see 5.12) at the boundary of their EM Zone. So the choice of filter might also depend on its style of housing – how well it can be integrated into a shielded barrier, see 5.12.11.

For more detail on the above and other filter selection issues, refer to [69] and [70].

5.10.2 Choosing filters for signals (including control and data)

Similar considerations to those discussed above apply to choosing

signal filters, but manufacturers generally only provide matched 50/50 data for such filters, or matched data for tests with source and load impedances more appropriate to the types of signals or data the filters are intended for (e.g. 100Ω). High-speed signals and data are usually communicated via ‘transmission-line’ cables, and where filters are used they must be of the correct type for that exact type of transmission line, otherwise signal quality will be lost.

Some types of signal connectors (e.g. in D-types and military-style circular connectors, see Figures 44 and 47) are available as standard with built-in filters. Some of these are simple ferrites needing no RF Reference connection (see 5.10.3) and many are simple capacitors, but more costly and higher-performance types are available based on ‘filter pins’, which can even use Tee or Pi filtering techniques.

A cable that is suffering from emissions or immunity problems at frequencies needed for control, data or other signals cannot use filtered connectors pins at those frequencies, because filtered pins act on the DM signal and so would filter out the wanted signals as well as the unwanted noise. If fitting ferrite CM chokes to the cable does not solve the problem, it may be necessary to use filtered pins to attenuate just the higher noise frequencies, and cable and connector shielding techniques to attenuate the noise frequencies associated with the wanted signal frequencies.

So, when choosing connectors for signal cables for connection to the boundary of an EM Zone, it can be helpful to choose types that have the options of being fitted with both filters *and* 360° shielding

backshells, so that filtering (and/or shielding) can be more easily employed if found to be necessary.

5.10.3 Ferrite filters need no RF Reference

Some filters rely solely on ferrites and have no need for any connection to the RF Reference. This type includes the cable-mounting chokes for which some examples were shown in Figure 58, and they are especially useful where the RF Reference does not provide a low impedance at the frequency to be filtered. For this reason they are often useful in installations for reducing emissions or improving immunity at walkie-talkie and cellphone frequencies, from 200MHz to over 2GHz, where sheet metal MESH-CBNs are not used (see 5.12).

There are many types of ferrite chokes available, but the appropriate types will be listed as being suitable for RF suppression. Less-common terms for them include 'shield beads' or 'shielding ferrites'. Ferrites cores and toroids intended for power applications, such as in switch-mode power converters, use types of ferrite material that are not suitable for use in RF filters.

High levels of attenuation cannot be expected from simple ferrite choke filters like these, although quite good results can sometimes be achieved by stringing several of them along a length of the cable to be filtered, no further apart than $75/f$ at the frequency concerned (f in MHz). Make sure the cable does not loop back to lie close to itself at any point along its length, and has no other cables nearby (unless they also have ferrites at the same location). Lying ferrite cable-mounted chokes on the RF

Reference adds some stray capacitance that can increase their attenuation – but only where the RF Reference has a low impedance at the frequency concerned.

Fitting ferrite chokes around a whole cable or cable bundle that includes the send and return conductors for each signal or power cable attenuates the CM currents and voltages; whilst fitting them around an individual send or return conductor acts on the DM.

Because DM currents are much higher than CM, they are more likely to saturate the ferrite and stop it from filtering at all, but it is also possible for CM chokes to be saturated, especially if some of the DM return currents flow back outside of the cable or bundle. CM chokes are less likely to saturate, and more likely to give good results, when the cables they are fitted on are centred inside them, by using plastic foam or other filling materials where necessary. Ferrites that feel warm are in saturation and ineffective, but not all saturated ferrites feel warm. Comparison of the ferrite manufacturers' product data, plus knowledge of the currents (or trial and error) avoids saturation problems.

5.10.4 Bonding filters to the RF Reference

Most types of packaged filters – and all medium or high-performance filters – contain capacitors RF-bonded to their metal bodies. It is vital for their EMC performance that their highly conductive metal bodies are RF-bonded to a local RF Reference that has lower impedance than their capacitors at the frequencies for which the filter is intended to achieve useful attenuation. The RF Reference bonds must be made *at least* at all of the filter's fixing points.

Filters can be fitted anywhere in an installation, but they are mostly used for indirect RF-bonding of unshielded conductors that cannot be RF-bonded directly to the BRC (e.g. mains power) at the very point where they cross an EM Zone boundary, as has been mentioned many times in this Guide already, see Figures 17, 37, 38 and 39.

Figure 37 shows a chassis-mounted filter RF-bonded at all its fixings to a bonding plate connected to the BRC that forms the boundary of an EM Zone. Figures 38 and 39 show similar filters RF-bonded to a cabinet backplate and cable tray respectively, as their conductors cross EM Zone boundaries.

Where the boundary of an EM Zone must be a closely-spaced mesh, or sheet metal to provide shielding, as discussed in 5.12, 'through-bulkhead' filters and filtered connectors will cause the least degradation of the EM Zone boundary's attenuation performance. Their input cables are on one side of the shielding boundary, and their output cables are on the other, so that the shielding at the EM Zone's boundary reduces the stray capacitive and magnetic induction that would otherwise allow unwanted noise to circumvent the filters.

Figure 61 shows three examples of mains filters mounted in a sheet metal wall at an EMC Zone boundary (although it could also be a bonding plate in the BRC at a mesh-shielded boundary). The centre filter is a proper through-bulkhead type, and the one on the right is combined with an IEC 320 style 'appliance-inlet' mains connector.

In both cases, good filtering performance will not be achieved unless their metal bodies are RF-bonded metal-to-metal to the plate they are mounted on, at multiple points around the perimeter of their mounting holes. Many EM Zones have had their shielding/filtering performance completely ruined by a lack of attention to the detail of these RF-bonds.

Where modest EMC performance is required from the EM Zone boundary, it may be enough to rely on RF-bonds at the filters' normal fixing points, but for high levels of EMC attenuation at a zone boundary – especially at frequencies above 100MHz – a conductive gasket may be required to bond a filter's metal body to the metal surface all around the periphery of its mounting hole. All the issues discussed in 5.7.1 to 5.7.5 apply to such gaskets.

Appliance-inlet filters are low-cost, but are not available with current ratings above 15A single-phase, and very few have as many as two internal stages, so their attenuation is never amazing. Through-bulkhead filters can have very high performance and current ratings of hundreds of Amps, but such types tend to be costly.

If a chassis-mounted filter is used instead, its installation requires a short length of external cable to penetrate the bonding plate, and this can induce noise in other conductors inside the EM Zone, and/or behave as an accidental antenna, compromising the shielding achieved by the EM Zone's boundary.

Figure 61 Mounting through-bulkhead filters in metal plates in EM Zone boundaries

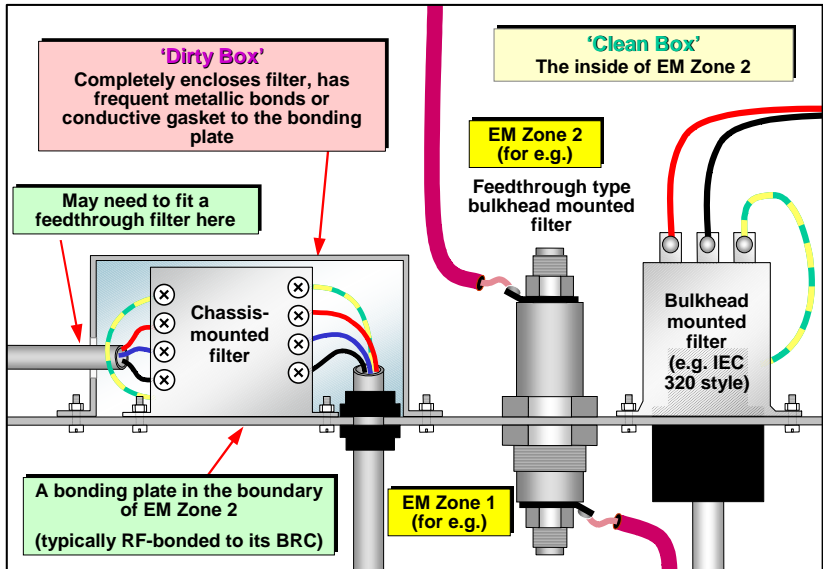

However, chassis-mounted filters can use what is usually called the 'Clean Box /Dirty Box' method shown in Figure 61, to improve their performance without adding much cost. Attention to detail is needed to achieve good EMC performance with this technique, especially:

- Minimising any gaps in the RF-bonding around the edges of the Dirty Box, which should have metal-to-metal fixings (see Figure 29) to the inside of the Clean Box with spacings *much* less than $30/f_{\max}$ (f_{\max} in MHz gives the maximum spacing in metres) for example for good filtering at 100MHz the spacing of the RF-bonds should be $\ll 300\text{mm}$, and $<30\text{mm}$ is recommended. A conductive gasket would be even

better, and a welded seam would be best.

- Reducing the stray coupling between the filter's input and output cables inside the Dirty Box by keeping them very short and far apart from each other.

There will still be some coupling between the filter's input and output cables inside the Dirty Box, especially at frequencies above 100MHz, so a high-frequency through-bulkhead filter may need to be fitted to one of the cables. Often, all that is needed is to add one or more ferrite cable suppressers (CM chokes, see Figure 58) to one or both cables close to the Dirty Box.

'Room filters' are high-performance versions of chassis-mounting filters

specifically designed for penetrating the walls of shielded EM Zones without compromising their SE. They incorporate compartmented shields for their input and output terminals (effectively two separate Dirty Boxes), and their filtered outputs enter the shielded room through a metal conduit that makes a 360° RF-bond to the metal plate in the boundary of the EM Zone. Some examples are shown in Figure 59 above.

Room filters are generally designed to achieve attenuations of at least 80dB from 100kHz to at least 1GHz, and types are available that go down to kHz and/or up to 40GHz and/or meet military specifications such as TEMPEST.

Mains filters are installed at the point where power enters an EM Zone, generally before the isolator for that zone. So their terminals can remain live even when the power is switched off in their zone, and require touch protection and appropriate safety warnings (be sure to meet all the requirements in the relevant safety standards). Figure 61 does not show the protective covers that may be required for safety.

5.11 Cable shielding

5.11.1 Choosing cables

Sections 5.7.5 to 5.7.9 discuss certain issues associated with RF-bonding of cables shields, and 5.7.10 discusses how much easier and more effective it is to use braid-shielded cables instead of types that use wrapped-foil with a drain wire. It also describes how, in polluted atmospheres, wrapped-foil shields can oxidise in just a few years and lose all their shielding.

Some cable manufacturers, such as Belden (Z-fold cable) and Alcatel, offer some types of cable with shielding based on solid aluminium foil, or even extruded thin aluminium, that overcome some of the problems with spiral-wrapped foil types. But braid is generally the best overall.

4.4 discussed keeping the send current in intimate proximity with the return current over the length of a cable, and this is best achieved using a twisted-pair type of cable. So the best kind of shielded cables for EMC purposes, are braid-shielded twisted-pairs.

The shielding effectiveness (SE) for a cable entering/exiting an EM Zone must be at least as good as the SE of the volumetric shielding achieved around that EM Zone. This is usually not difficult to achieve when using meshed shields around EM Zones (see 5.12), providing they are RF-bonded as described in 5.7.5 to 5.7.8 but it is very important indeed when using high-specification shielding around EM Zones (see 5.12.8).

There are very many types of shielded cables, offering a range of choices of shielding effectiveness, size, flexibility (minimum bending radius), ease of shield termination, and cost. It is good practice to check whether suppliers recommend specific types of cables (or even a specific manufacturer and part number) for use with their equipment or systems – and then use the same type of cable or one with a better specification.

The shielding performance of cables and connectors is generally measured as their 'surface transfer impedance' Z_T , which is simply the ratio of the voltage of the RF noise induced on their shielded inner conductors to the RF noise current

injected into their shield, and is measured in Ω /metre of cable length as shown in Figure 62. Good shielding generally requires that Z_T be less than 1Ω at all of the frequencies to be shielded from, with $100\text{m}\Omega$ being very good, $10\text{m}\Omega$ being excellent, and $1\text{m}\Omega$ being about the best achievable.

So-called 'superscreened' cables are the very best flexible cables available, and a typical type will have two or more braid shields separated by wound tapes made

of special metals with extremely high permeability (e.g. MuMetal™). Unfortunately, they are very costly and so only tend to be used in military, government and aerospace applications.

All other types of flexible shielded cables have a Z_T that continually worsens as frequency increases above a breakpoint that generally lies between 1MHz and 100MHz . The better the cable for EMC, the higher the breakpoint, as shown by Figure 62.

Figure 62 Z_T s for some typical types of cable shields

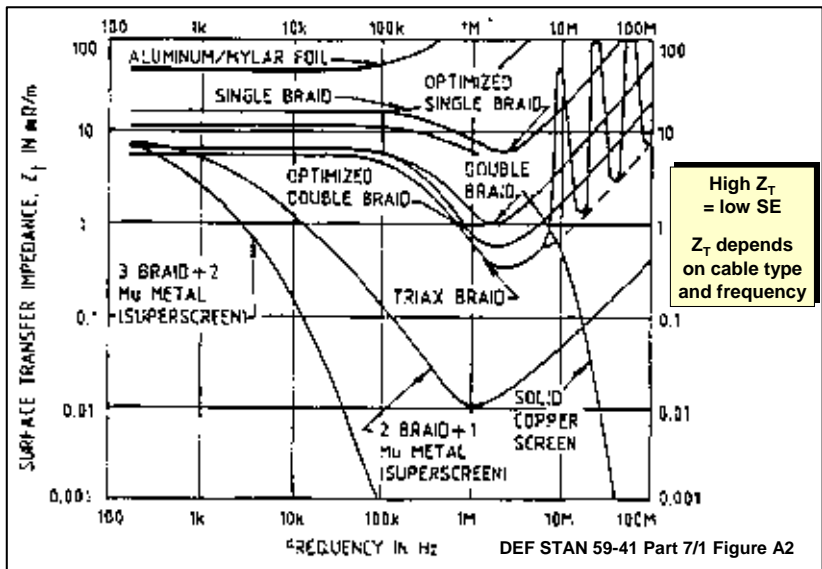

Lossy cables are also available, with braid shields plus a spiral wrapping of silicon-steel tape that behaves rather like a distributed ferrite choke.

The best braid shields tend to have low resistance, which means they have a high cross-sectional area and contain a

lot of copper, plus a good optical coverage (very small gaps between braid wraps). 'Optimised braid' shielded cables are available from some suppliers, which despite having optical coverage of under 90% have lower Z_T than even a 95% optical coverage braid.

To get even better shielding requires multiple shield layers, such as braid+foil and double uninsulated braids. Braid+foil works best when the metallised surface of the spiral-wrapped foil is in contact with the braid along its length.

Triple shielded cables are also available. Generally speaking, going from one braid to two, and from two to three, increases the SE by 20dB each time.

Double *insulated* shields can be as good as double-uninsulated types up to some frequency, but above that frequency they resonate and are only as good as a single braid. It is best to reserve them for special requirements needing separate shields, such as the situation described in 5.11.2.

Multicore shielded cables are available that can include a variety of types of conductors (straight, twisted pair,

coaxial, etc.) either individually shielded or not, with an overall shield of braid, braid+foil, double braid, etc.

Cables can have shielding added using 'overbraids' and flexible shielded conduit, available from several manufacturers. These can easily be slipped over the cable and 360° bonded at both ends, either to add a shield, or to add a second or third shield. Figure 63 shows some Z_T figures for a range of overbraids.

When choosing connectors for signal cables for connection to the boundary of an EM Zone, it can be helpful to choose types that have the options of being fitted with both filters *and* 360° shielding backshells, so that filtering (and/or shielding) can be more easily employed if found to be necessary.

Figure 63 Examples of some overbraids' Z_T s

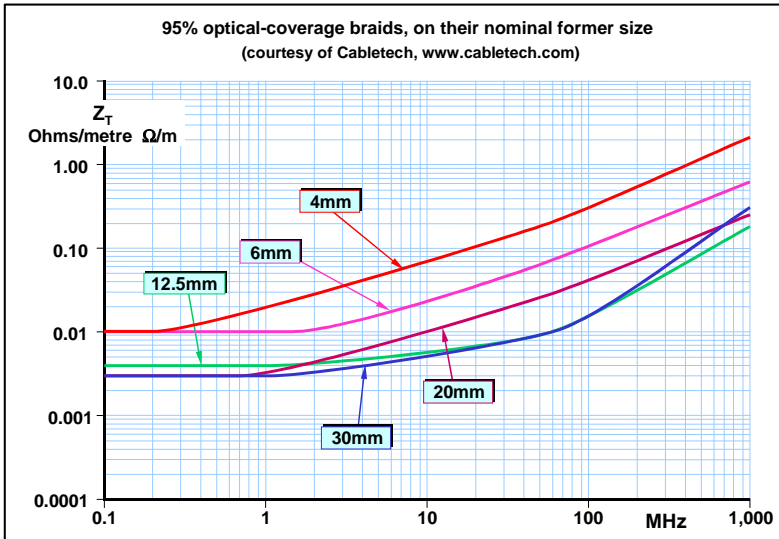

Figure 62 shows that a solid copper screen (e.g. microwave 'semi-rigid') does not suffer from rising Z_T above some frequency – its Z_T always *improves* as frequency increases. This shows that solid conduit also makes an excellent shield.

5.11.2 When good cable shield-bonding practices contradict supplier's instructions

It sometimes happens that two items of equipment need to be interconnected by a shielded cable but are installed in different EM Zones. Problems arise if one equipment is supplied with EMC instructions that state that its cable

shield must only be connected at one end (usually at that item of equipment, and usually to a screw-terminal or connector pin).

Leaving aside the issues of whether the supplier had used good EMC design, or was simply regurgitating 'traditional' EMC instructions that are now decades obsolete – unless the supplier can be persuaded to alter his EMC instructions they should be followed or else he will disclaim all responsibility for interference, and possibly for other malfunctions too.

Figure 64 When bonding a cable shield at both ends contradicts supplier's instructions

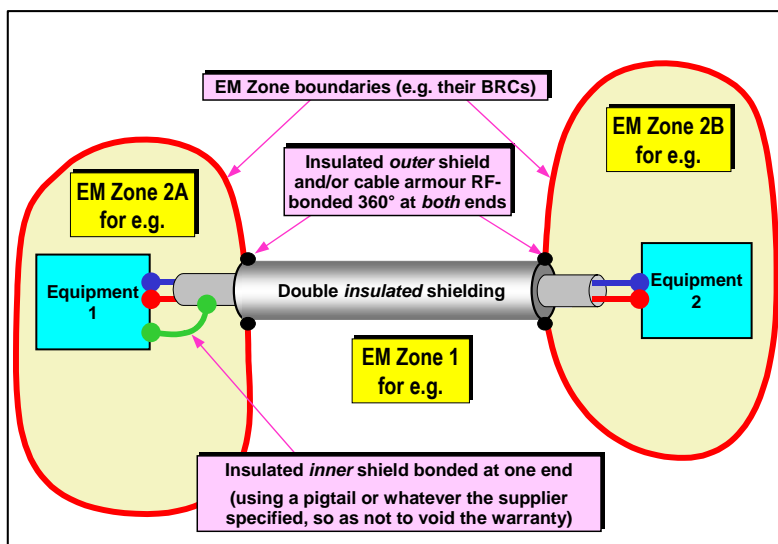

The problem is that unless the shield is RF-bonded at the point where it crosses the boundary of each EM Zone, it will compromise the EMC performance of those zones – but the suppliers instructions forbid this. Figure 64 illustrates one solution – use a double *insulated* shield cable and RF-bond the outer (insulated) shield layer to the BRCs of each EM Zone in the appropriate manner (see 5.7.5). The inner shield layer can then be terminated in accordance with the supplier’s EMC instructions.

Multicore shielded cables are available that can include a variety of types of conductors (straight, twisted pair, coaxial, etc.) either individually shielded or not, with an overall insulated shield of braid, braid+foil, double braid, etc. These can be used like the cable type shown in Figure 64 to connect a variety of cables all at once between equipment in separated EM Zones. Also, an overbraid or flexible shielded conduit, or solid conduit, could be used as the insulated outer shield in Figure 64, with one or more cables inside it, either shielded or not.

Where both equipment suppliers insist that the cable shield must only be bonded at one end, and they don’t agree on which end, the method of Figure 64 can be used with a triple-insulated shield. One inner shield connected to one item of equipment, the other inner shields to the other equipment, and the outer at the boundaries of the EM Zones. If triple-insulated shielded cables are not readily available, use a double-insulated shield with an overbraid or shielded conduit (see 5.11.1).

5.12 Shielding for EM Zones

5.12.1 Introduction

EM Zones can be shielded by a variety of materials, including:

- Sheet metals: solid, foil
- Perforated metal sheets, ‘expanded’ metal, etc.
- Meshes: chicken wire, weldmesh, heavy steel rebars, natural metalwork, etc.
- Conductive paint
- Metallised fabrics

The essential principles of shielding an EM Zone are shown in Figures 65 and 66. Figure 65 shows the desired boundary of a new EM Zone, and indicates all of the conducted, induced and radiated threats to the equipment within it. Figure 66 shows sheet metal walls, floor and ceiling creating a shielding boundary around the EM Zone to protect it from induced and radiated threats.

Figure 66 also shows that – providing all conductors are RF-bonded to the wall either directly or indirectly (see 5.7, 5.10.4 and 5.13) – the EM Zone is also protected from conducted EM threats.

Although Figures 65 and 66 show threats to the equipment in the EM Zone 2, exactly the same principles apply if EM Zone 1 is being protected *from* the emissions of the equipment in EM Zone 2.

The principles shown in Figures 65 and 66 apply equally well to EM Zones shielded with wire meshes, conductive paint, metallised fabrics, rebar meshes, etc.

Figure 65 Overview of threats to an EM Zone

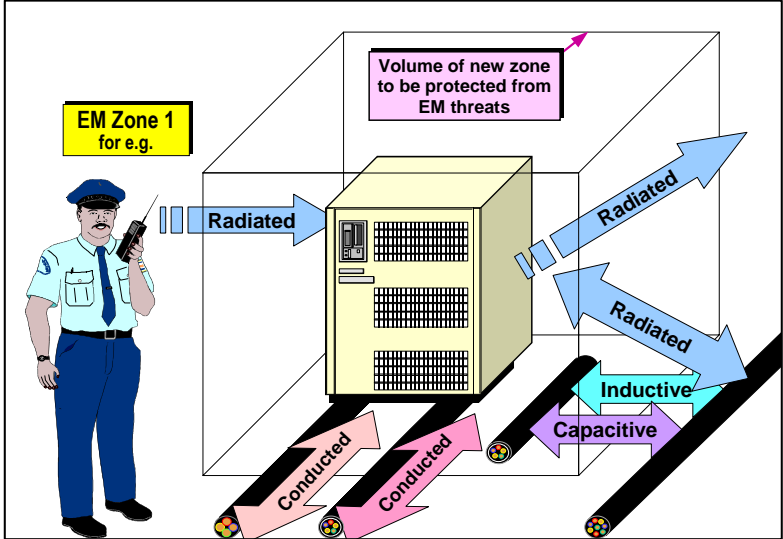
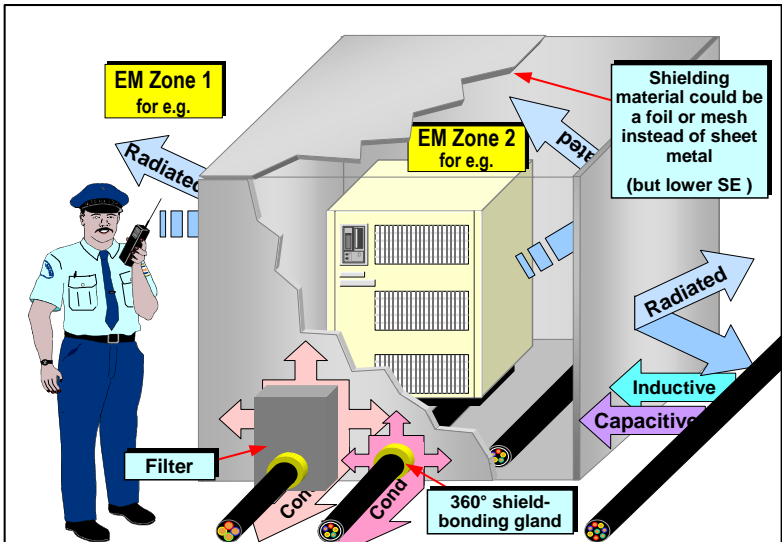

Figure 66 Using shielding and RF-bonding to create EM Zone 2



Achieving EM shielding for a room, several rooms, or even a complete building is usually called architectural shielding [71]. It requires great attention to detail and should not be lightly undertaken. Section 5 of [36], and its figures 56 to 62, describes how to design and construct sheet metal shielded enclosures for industrial cabinets – and exactly the same techniques are required for sheet metal shielded enclosure of any size, including entire buildings many 10s of metres on a side.

Doors and windows (see 5.12.13), air vents, lightning, cable and service entries, all cause great problems for architectural shielding. It is difficult enough trying to make an industrial cabinet with an SE of over 60dB at over 100MHz, but it is much worse for a room or building because the doors and windows are larger, the seams and joints are longer, and it is more difficult to control the activities of electricians and others (a management problem that is common to all EM Zoning, see Section 8).

A long and costly learning curve is the lot of those who want to construct high-specification shielded enclosures the size of rooms or buildings. Although [60] includes a lot of useful guidance for those who want to try, it is mostly aimed at facilities that have to withstand up to 100MHz – every decade increase in frequency (e.g. from 100MHz to 1GHz) means gaps and joints have to be ten times smaller for the same shielding specification, filters and cable shield bonds have to be higher-specification too, and errors and oversights cause ten times the performance degradation at 1GHz than they do at 100MHz.

As a result, this Guide *very strongly recommends* that – where it is desired to shield the zones in an existing structure to a high specification – companies specialising in architectural shielding (and with good references from previous customers) are employed.

The following sections include a lot of material on rebar meshing, because most modern constructions use reinforced concrete so the rebars are free, and also because this method is recommended by [3] for the protection of electronic equipment from LEMP (see 5.13). Also, there is considerable experience in the use of rebar meshes in the construction of military facilities for protection from HEMP and EMP [60].

Electric fields can easily be attenuated by lightweight foils, meshes, paint and fabrics but magnetic field shielding at frequencies between 1kHz and 10MHz – where the destructive energies of lightning and EMP events are concentrated – requires substantial thicknesses of metal.

Adding heavy-gauge sheet steel all around an EM Zone requires the structure and fixings to be able to support the weight of all that metal, whereas rebar meshes contain quite a large mass of metal and so provide useful magnetic field shielding over these frequencies, and are part of the supporting structure anyway.

5.12.2 Creating effective mesh shields

Filters (see 5.10) attenuate conducted EM phenomena, whilst shields attenuate radiated phenomena (electric, magnetic and electromagnetic fields (see 3.3).

Shielding from EM fields using a conductive mesh, and reducing the

mesh dimensions to improve SE, were mentioned in 5.5, for a MESH-CBN that encloses an EM Zone (three-dimensionally, i.e. as a volume). As Figure 23 shows, all existing metalwork can be pressed into service in the creation of the shielding mesh, to save cost.

Concrete or metal structures can bond all the metal in their walls and roofs as part of the MESH-CBN, including reinforcing bars ('rebars'), girders, metal window and door frames, cladding, etc., as shown in Figure 67, which is copied from [3]. A similar figure also appears in [60].

Figure 67 Example of using rebars, windows and doorframes in a MESH-CBN shield

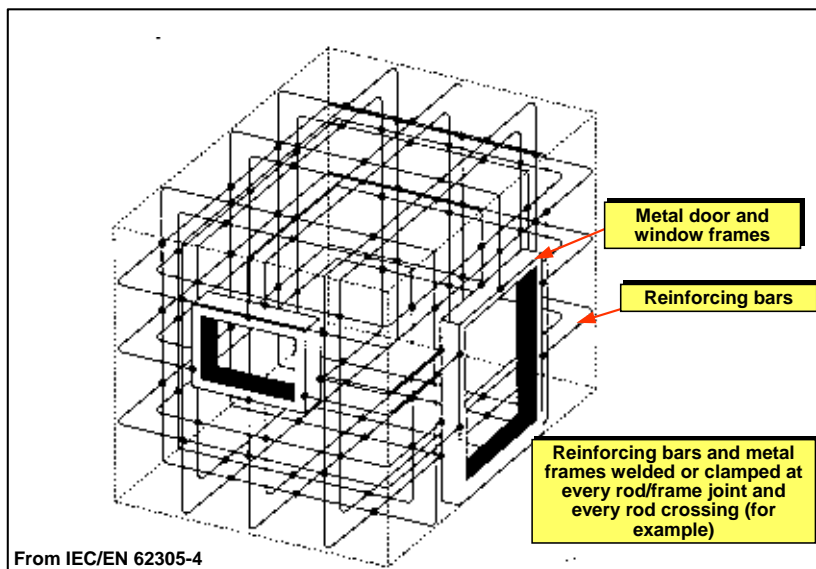

In years past it has been common practice to bond rebar joints by wrapping wire around them, or by spot-welding them. Pre-spot-welded mesh ('weldmesh') has been another solution. Unfortunately, all these techniques are unreliable – pouring the concrete can break spot welds and wires, and welds and wires often corrode – so the mesh created is not as good as was desired, and degrades over time.

However, many buildings are made from reinforced concrete, and it is very cost-effective if their reinforcement metalwork could be used as a MESH-CBN volumetric shield. This is addressed in the lightning protection standard [3], and an example of its recommended method for RF-bonding rebars, which relies upon using seam-welds at least 30mm long, is shown in Figure 68. These seam-welded joints are not necessarily required at all rebar crossings, only at the locations

that achieve the necessary shapes and sizes for the mesh elements.

According to [3], an alternative to seam-welding is to use clamps that comply

with (and have passed tests to) EN 50164.

Figure 68 Recommended method for welding the joints in rebar meshed shields

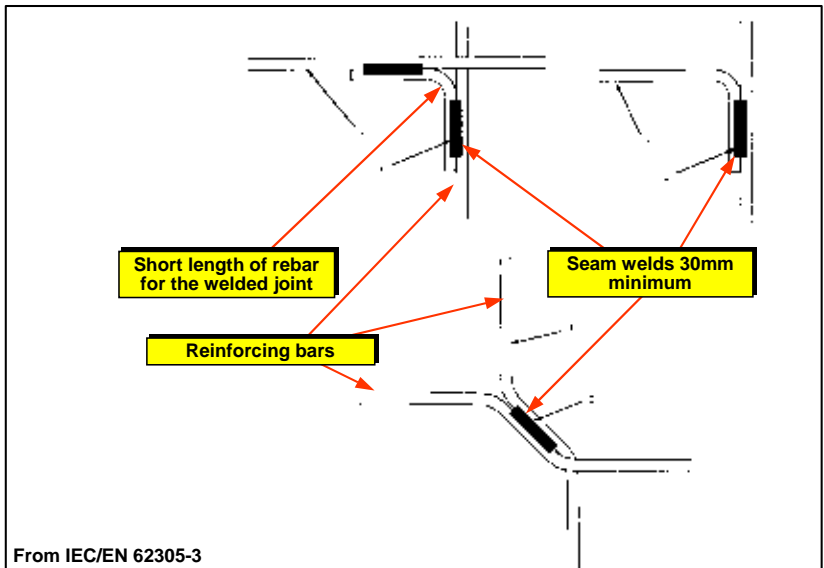

To connect a rebar mesh to the rest of the MESH-CBN, short lengths of rebar are cut, bent, and seam-welded at least 30mm, or clamped (as above) to the rebar mesh, angled so that they stick out perpendicular to it. When the concrete is poured, these bars will then protrude out of the concrete walls, floors or ceilings for RF-bonding to the rest of the metal CBN structure. Of course, the concrete shuttering will have to be fitted around these bonding bars before the concrete is poured.

A properly-design and well-constructed rebar structure makes a useful shield for

an EM Zone, and since all buildings have walls and a roof one obvious application is at the boundary between EM Zone 0 (the uncontrolled EM environment in the outside world) and EM Zone 1, as shown in Figure 17.

5.12.3 SE for magnetic electric fields, and the magnetic field component of plane waves

It is difficult to provide simple guidance for the magnetic field SE achieved by a mesh of rebars, or of other kinds of conductors, such as copper wires. Table A.2 in Part 4 of [3] gives a formula

for the SE of a rebar mesh that is equivalent to: $SE = 20\log(12/D)$, where D is the size of the largest mesh diagonals in metres – but it applies this formula for both 25kHz and 1MHz.

A mesh becomes very ineffective at frequencies above 50/D MHz, and provides no SE at all above 150/D MHz. One would expect that the SE of a mesh would improve as frequency decreases

below 50/D MHz, but the formulae in Table A.2 of Part 4 of [3] have no frequency dependence. Figure 69, which is mostly copied from figure 10.26 of [58], provides the reason for this in the form of some graphs for the magnetic-field SE in a volume shielded by a square mesh created by welding 16mm diameter concrete reinforcing bars where they cross.

Figure 69 Magnetic field SE varying with frequency and size of rebar mesh

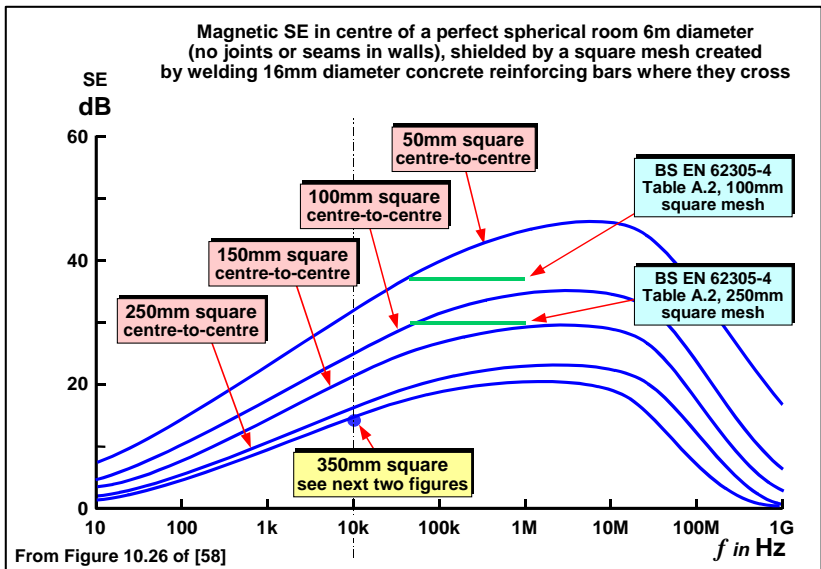

Clearly, the mesh SE does vary with frequency, but there are at least two different mechanisms at work. From very high frequencies down to some frequency, the SE performance improves as frequency decreases, but as the frequency continues to decrease it reaches a value at which the SE starts to *reduce* as frequency reduces. In the region between these two slopes, the two mechanisms seem to cancel each

other out, resulting in a plateau region for the SE.

The 25kHz and 1MHz frequencies used in [3] lie within this plateau region, which probably explains why the formulae provided in its Table A.2 are not frequency dependent.

Figure 69 compares the results of two calculations from Table A.2 of BS EN 52305-4:2006 with the graphs from

Figure 10.26 of [58], and shows that they are up to 10dB higher, so maybe it is best to treat the mesh SE predictions of [3] rather conservatively. Figure 5-31 in [60] is similar to Figure 69, but only covers 100Hz to 1MHz.

Figure 69 shows that reducing mesh size improves SE, but the SE figures are not very large compared with what can be achieved using sheet metal walls, floors and ceilings (see 5.12.8).

There are no simple calculations that can estimate the SE of a rebar mesh over a wide range of frequencies, but Figures 69 to 71 make it possible to estimate it for a range of EM Zone sizes, and a range of rebar diameters and mesh sizes.

Figure 69 shows how a number of rebar mesh sizes vary with frequency, for

16mm diameter rebars. Figure 70, created by merging figures 5-27 and 5-28 of [60], shows how the SE achieved at 10kHz at the centre of a mesh-shielded EM Zone varies with the size of the zone, assuming it is a rectangular volume. Only one mesh size is given: 350mm centre-to-centre (i.e. $D = 495\text{mm}$), and only two zone heights are given, 5m and 10m but the ranges of zone lengths and widths are quite large.

[60] is a very suitable reference for this Guide, because EMP has significant frequency content to 100MHz and so [60] includes practical techniques for constructing facilities to resist such threats from their external EM Environment, whereas lightning standards are generally only concerned with EM threats up to 10MHz.

Figure 70 Magnetic field SE varying with EM zone volume, at 10kHz

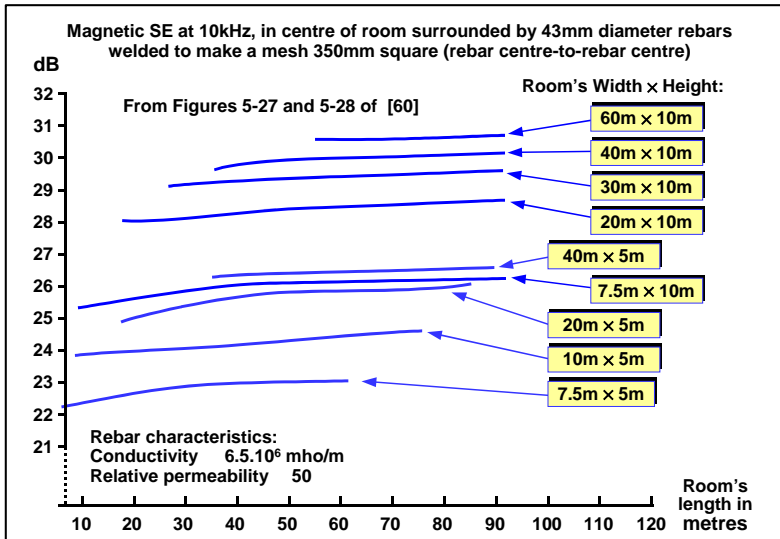

It was mentioned in 5.5 that – close to its surface – a mesh is not effective as a shield, and that equipment and cables should be located no closer than D to the mesh, as shown in Figure 18. It was also mentioned that the best location for sensitive equipment is in the centre of a structure, and Figure 70 makes this point again, but this time with useful numerical data.

The reduction in SE as frequency reduces, on the left of Figure 69, is due

to the lack of metal in the rebars. The wavelength is so much larger than the mesh diagonal that the EM fields just see the average of the metal, so thicker rebars will give better SE, as shown by Figure 71.

Figure 71 is taken from Figure 5-29 of [60], and is a partner for Figure 70 allowing its 10kHz SE predictions for a 350mm square mesh to be adjusted to allow for different mesh sizes and rebar diameters.

Figure 71 Magnetic field SE varying with rebar diameter and mesh size, at 10kHz

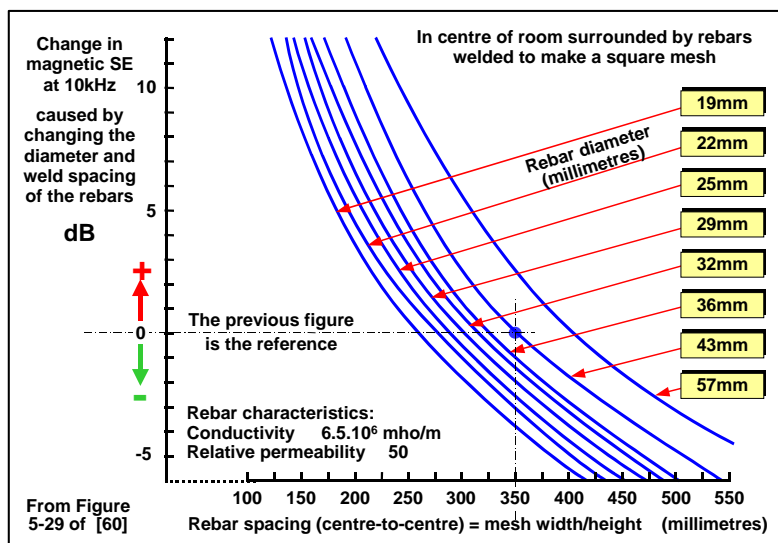

The author has drawn an extra curve on Figure 69 corresponding to a 350mm square mesh of 16mm diameter rebars, with a dot at 10kHz, so that Figures 69-71 can be used together to estimate the SE of rebar meshes, as follows:

- The EM Zone size is compared with Figure 70 and a reasonable match

obtained, giving an SE value for 10kHz only.

- The rebar diameter and square mesh size is then compared with Figure 71 and the resulting correction factor applied to the SE value from Figure 70. Still only at 10kHz.

- Then a correction factor derived from Figure 69 is applied, from its 250mm curve, for the frequency concerned.

[60] provides more detail on using this process, including worked examples.

Figures 69-71 work on the width of a square mesh, but not all meshes are square, and when using rectangular or odd-shaped meshes take their longest diagonal D and divide it by 1.414 to get the equivalent square mesh centre-to-centre spacing for use with Figures 69-71.

When using a double-layer of rebars, with each layer constructed identically as a mesh for shielding purpose, [60] says that the effect on SE is the same as halving the spacings in Figure 71.

5.12.4 Augmenting a rebar mesh with wire mesh and similar

Certain types of wire meshes are suitable for use in rebar structures and will withstand the pouring and setting of the concrete. They can be draped over a rebar mesh shield before pouring concrete, to improve the magnetic field SE at frequencies above 10MHz. Around 10kHz they will only make a difference of a few dB, because they do not have a sufficient mass.

The material should have small mesh sizes (e.g. a D of 30mm or less) and it should be reliably clamped, soldered, brazed or welded at all joints and seams in such a way that there are no gaps larger than D all around the EM Zone to be protected.

Figure 9.27 of [72] gives some examples of the magnetic field SE achieved by using a variety of perforated metal sheets and wire meshes. The author understands that where it talks about a

“#2” or “#4” mesh (etc.) this refers to the number of metal wires per inch across the mesh. So a #2 mesh would have a square mesh with a centre-to-centre spacing of 0.5 inches (12.5mm) and a D of 14mm.

5.12.5 SE of mesh for electric fields and plane waves

It is generally assumed that the electric field SE of a single aperture in an infinite metal sheet is given by $20\log(150/Df)$, where f is given in MHz and D is the largest diagonal of the aperture, or its diameter, given in metres. For multiple apertures it is generally assumed that the SE will reduce by $20\log\sqrt{N}$ dB, where N is the number of apertures – but this correction factor only applies where all the apertures are contained within an area that is one-quarter of a wavelength or less, which is obviously not the case for large structures at all frequencies.

The problem with trying to apply these two simple formulae to mesh shielding a large vehicle, vessel or building, is that the SE values come out very low indeed, or even negative, nothing like as good as the SE values for magnetic fields discussed earlier.

The author has not been able to find any substantial guidance for the electric field SE of a large mesh-shielded structure to electric fields, since most of the literature is concerned with EMP and Lightning for which the largest threats are produced by magnetic fields.

However, table 9.9 on page 9.48 of [72] and tables 5-14 and 5-15 in [60] give some examples of the electric field and plane-wave shielding achieved by various kinds of perforated metal sheets and wire meshes when used to shield a

building. It appears that the mesh size has to be very small, when compared with a mesh of rebars (see 5.13.3), to achieve any reasonable SE values. For example, over the range 100Hz to 1GHz:

- 0.03 inch (0.75mm) diameter galvanised steel wire in a square mesh of side 0.5 inch (12.5mm) achieves a minimum electric field SE of 24dB.
- 0.03 inch (0.75mm) diameter galvanised steel wire in a square mesh of side 0.25 inch (6.3mm) achieves a minimum electric field SE of 28dB.
- 0.02 inch (0.51mm) diameter copper wire in a square mesh of side 0.083 inch (2.1mm) achieves a minimum electric field SE of 50dB.

It seems that if sheet metal or other continuous shielding is not to be applied (see 5.12.98 and 5.12.9), and it is desired to rely on a rebar mesh for shielding, the method described in 5.12.4 should be used.

5.12.6 Shielding due to concrete itself

The attenuation of ordinary concrete, ignoring the contribution from any reinforcing bars, depends upon its moisture content. [73] found that with a moisture content of 0.12%, 300mm thick concrete gave an SE of between 1 and 3dB depending on frequency, but with 12% it gave between 10 and 20dB over a wide frequency range up to at least 2GHz. Table 5-20 of [60] also gives some figures for shielding due to moisture content of building materials.

Conductive concrete has been made by adding, for example, crushed coke to the

mix, and this has achieved a degree of SE. Carbon coated polystyrene beads admixtures are investigated in [74] and [75], a method that seems to be aimed at increasing the lossiness of the concrete rather than making it conductive.

Although the SE values obtained (without weakening the concrete by too much) are modest, they may nevertheless be useful, especially when used in combination with a meshed rebar structure.

5.12.7 'Nesting' EM Zones to improve SE

Nesting EM Zones (see Figure 17) can multiply the low SE figures achieved by mesh-shielding. For example a building 40m cube might use a mesh in its walls, floor and roof that achieves an EM Zone 1 with a minimum of 20dB SE over the frequency range of interest. If an EM Zone 2, say 30m cube, is located completely within the building and uses using a similar mesh shield construction, without sharing any shielding with the boundary of EM Zone 1, then the overall SE of EM Zone 2 with regard to EM Zone 0 (the outside world) would be a minimum of 40dB.

A further EM Zone 3, say 20m cube, could then be nested within EM Zone 2, using similar construction to achieve a minimum of 60dB; and yet another EM Zone 4, say 10m cube, could be nested within EM Zone 3 again using similar construction to achieve a minimum of 80dB. The 80dB of SE achieved in this way would be very robust, and even if the building lost an external wall the SE would only degrade to 60dB. If achieved for example by welding rebars it could be cost-effective when compared with

the usual methods of achieving 80dB (see 5.12.8).

5.12.8 Shielding with sheet metal

EM Zones with meshed shields can achieve SEs of up to about 40dB at frequencies between 30kHz and 30MHz, but mostly achieve lower values (see 5.12.2–5.12.5). Where they can be achieved by using ‘natural’ metalwork, such as rebars, then they can provide useful shielding at low cost. Nested mesh-shielded EM Zones (see Figure 17) can usefully multiply these SE figures, as discussed in 5.12.7.

SEs of 60dB or more can be achieved, for both electric and magnetic fields, using solid (sheet) metal boundaries for EM Zones. The sheet metal itself can easily give SEs of over 100dB for frequencies over 1MHz, but in practice what limits the SE for an EM Zone shield are its apertures (seams, joints, etc.) and conductor penetrations (cables and metallic services such as air, water, etc.).

The sheet metal walls, floor and ceiling of an EM Zone are integral part of its MESH-CBN, just exactly as if the mesh shields discussed in 5.12.2 had shrunk their mesh size more and more until there were no gaps any more.

Similarly, sheet metal makes the best possible RF References, and is a technique generally used in

semiconductor fabrication plants because they are very critical for financial reasons – a single piece of equipment suffering EMI can cost millions of dollars in lost production per day.

Chapter 5 of [60] describes how to shield entire buildings using heavy-gauge sheet steel with welded seams, to achieve SEs of 100dB over frequency ranges to protect against EMP (see 5.13.4). Its chapter 12 describes how to make buildings and rooms with SEs of over 50dB for TEMPEST (data security) reasons, using such materials as copper foil backed with building paper. This Guide recommends leaving such work to specialist companies who are well along their learning curves, but if you want to have a go at doing it yourself, these chapters are a good place to start.

It is most convenient if the systems or installations that require highly-shielded EM Zones are restricted to small volumes that can be shielded by metal enclosures, often called ‘shielded rooms’, purchased from specialist suppliers of such rooms. Figure 72 shows an example of one such room, and annotates its major features, all of which should be familiar from the preceding sections of this Guide, and from [36]. Rooms like this are available with very good EM specifications indeed.

Figure 72 Example of a commercially-available shielded room

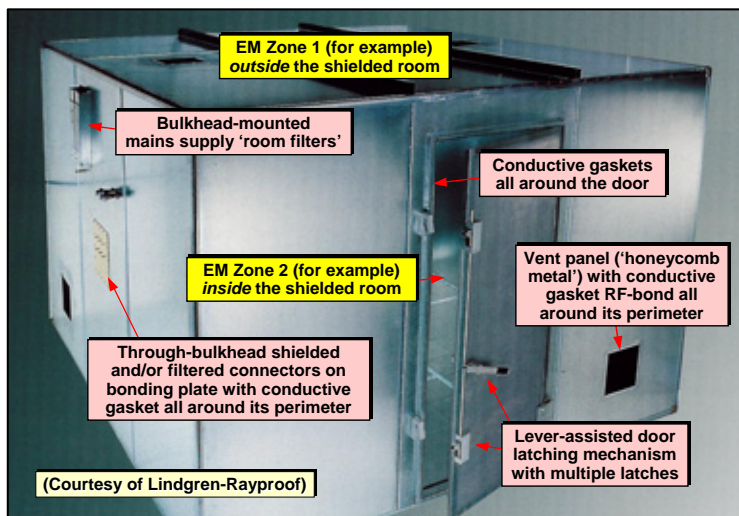

Figure 72 is an example of a bolted-together shielded room, made from chipboard panels with galvanised sheet steel glued on each side to provide two layers of shielding. Figure 73 shows some details of the construction at the bolted joints, which use long strips of folded steel to overlap at the joints. To improve the EM performance, copper or tinned steel tape with a pressure-sensitive conductive adhesive backing can be placed over all the seams. Even better performance is achieved by seam-soldering the tape to the metal walls all around.

Commercial suppliers of shielded rooms can provide them up to almost any size, and Figure 74 shows an example of quite a large shielded room inside a facility. With suitable metal support structures, shielded rooms can be stacked side-by-side and on top of each other to create very large facilities where

(with a bit of decoration) the personnel might not even realise they were working in shielded rooms. (Of course, they would have to keep their doors closed, and they would probably notice that they were very heavy if they were not power-operated.)

Compared with seam-welded shielded rooms, bolted rooms like Figure 72 and Figure 73 are easier to assemble and so cost less. However, [60] is very scathing about the performance, reliability and ageing of their bolted seams, and claims that maintaining their shielding performance over many years means refurbishing all of their bolted joints periodically, so their overall cost of ownership is higher than that of a room that is seam-welded throughout. However, bolted shielded rooms are (relatively) easy to disassemble to move to a different site, which might be an important feature

Figure 73 Some details of construction of a bolted-together shielded room

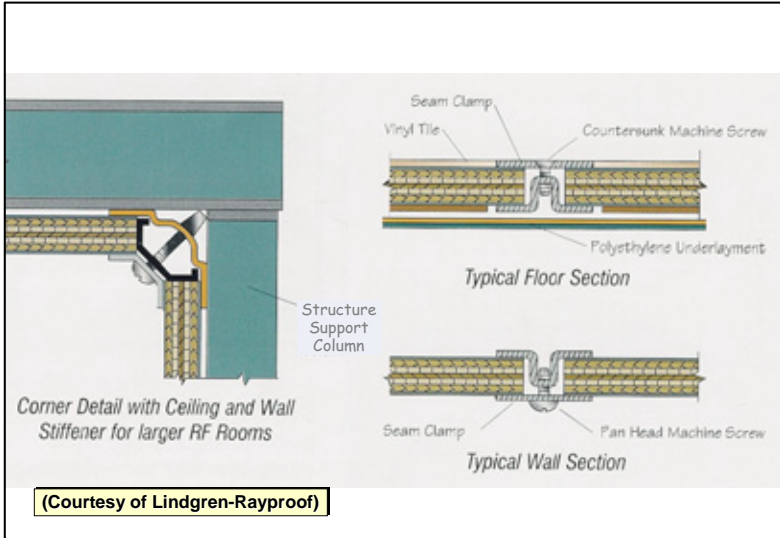

Figure 74 Example of a large shielded room in a facility



5.12.9 Using shipping containers

Standard shipping containers can be used as shielded rooms, with a bit of Do-It-Yourself, and they are very low-cost if purchased second-hand. They are entirely seam-welded from thick steel, and so strong that they do not need a

support framework. Figure 75 shows some stacked up in an industrial plant where they are being used as shielded EM Zones. If the main building in Figure 75 is EM Zone 1, the shipping containers in the photograph would each be EM Zone 2A, 2B, 2C, etc.

Figure 75 Examples of stacked shipping containers used as shielded EM Zones



Beware: some shipping containers are only spot-welded and the seams filled with mastic to simulate seam-welds! Test the welds with a sharp metal object to check they are real.

Figure 76 shows some sensitive measuring equipment installed inside one of those shipping containers. To use

a standard all-welded shipping container as an excellent shielded room with a very high SE requires its door to be modified, however, unlike the doors discussed in 5.12.13, the doors on shipping containers are very rigid indeed, and can compress conductive gaskets very nicely.

Figure 76 Inside one of the shipping containers from Figure 75



It is not too difficult to remove the paint from the mating surfaces of the door and its frame, paint the exposed steel surfaces (before they rust) with brushed-on tin plating, or zinc-rich or silver-rich conductive paint, or else apply a tin-plated tape that has a conductive adhesive. Conductive adhesive is very sensitive to dirt, damp and grease, even fingerprints, so when using it always take great care to clean the surface with degreaser.

Next, affix a soft self-adhesive conductive gasket strip to the conductive paint strip on the frame all around the door so that the conductive paint surface on the door presses firmly against it, making a good seal when the door is closed. The gasket should generally be compressed by between 20% and 70% (check its manufacturer's datasheet) and

there should be no light visible or air flow possible anywhere around to door gasket when the door is closed.

It may be necessary to modify the latching mechanisms for the door, to be able to open and close it against the force or friction of the gaskets.

Cables for power and signals must be RF-bonded to a bonding plate as they pass through the wall, as shown in Figures 61 and 72, and also as shown by Figures 79 and 80 (but with a solid metal wall instead of rebar in Figure 79).

Since the containers are made of thick steel, and very well seam-welded at all seams and joints, once the door gasketing has been done well (and the door closed) the result is a very high-specification shielded EM Zone.

5.12.10 Shielding with wire mesh, perforated metals or metallised fabric

Wire mesh (even 'chicken wire') and perforated metal can be used outside of concrete structures, and they can easily be stapled or nailed to a timber frame, maybe using a layer inside as well as one outside. Such wire-mesh rooms can be seen in the Hollywood movies "The Conversation" and "Enemy of the State".

The wire mesh or perforated metal should be overlapped by at least 30mm at all seams, and the seams RF-bonded

at least on the same pitch as the mesh or hole pitch. Figure 77 shows a shielded room made from Expanmet™ expanded metal, which gave good performance in the 50-60dB range. The only difficulty encountered with its construction was making a shielded door that would reliably seal to its conductive gaskets all around, a common problem that is discussed in 5.12.13. In the end a shielded room door and frame had to be purchased as a set from a specialist company, and fitted to the otherwise low-cost room.

Figure 77 Example of a shielded room made from expanded metal



There are several manufacturers of metallised fabric, which can be stitched to make a shielded tent, or to line the walls as part of an architectural shielding scheme. These fabrics are really only good for frequencies above 1MHz, and their maximum SE is often around 60dB,

but they can be very useful where an EM Zone needs to be created temporarily, for whatever reason.

Like all shielded EM zones their weak points are their doors, and conductor penetrations, and Figure 78 shows an

example of a portable shielded tent with a door that uses a hook-and-loop type of clothing fastener made from very fine stainless-steel wire. Tents made for

more permanent erection can be very large, and often use regular shielded-room doors and frames purchased from specialist suppliers.

Figure 78 Example of a portable shielding tent

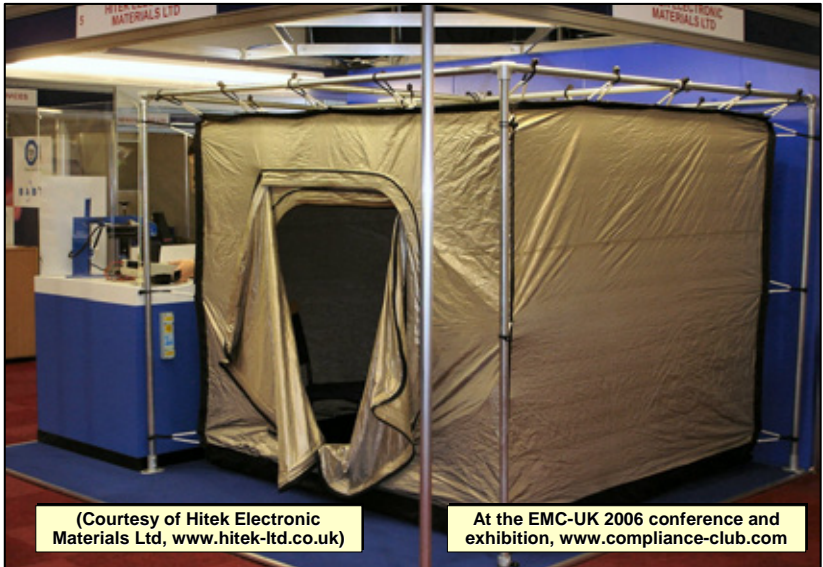

(Courtesy of Hitek Electronic Materials Ltd, www.hitek-ltd.co.uk)

At the EMC-UK 2006 conference and exhibition, www.compliance-club.com

The metallised fabric must be RF-bonded all around the perimeter of its metal floor, and all around the perimeter of the bonding plates required for direct and indirect bonding of conductors that need to penetrate the fabric. Shielded doorframes also must RF-bond to the fabric all around their perimeter. No seams or gaps are permitted if reasonable shielding performance is to be achieved.

Two layers of metallised fabric, one stretched over the outside of a timber frame and the other stretched over the inside, held in place with staples, can make a very effective shielded EM Zone

for frequencies above 100kHz. Joints in the fabric can generally be RF-bonded by folding the two edges over each other to make a seam and stapling it to a wooden frame underneath every 30mm or so.

5.12.11 RF-bonding conductors to the shield

Where the EM attenuation required at the EM Zone 0/1 boundary is only moderate (say, up to 20dB) and only required to control frequencies up to, say, 10MHz or so, it *might* be acceptable to RF-bond all the conductors entering/exiting the building directly or

indirectly to the BRC as described in 5.7, *providing* the BRC is RF-bonded in turn to the rebar mesh in the walls at intervals of no more than 5 metres along its entire length.

Where a small mesh-size is used for the rebar structure, and its full EMC performance is required, for example to provide good attenuation to at least 100MHz, all the conductors entering/exiting the building must be RF-bonded (directly or indirectly) to the rebar mesh itself, which will require a bonding plate similar to those shown in

Figures 37 and 38. In this case, the conductors should pass *through* the plate, so that their external length is shielded from their internal length by the plate, and by the rebar mesh.

Figure 61 showed some examples of how this can be done for indirect RF-bonding using filters, whilst Figure 79, taken from Appendix C of the old lightning protection standard BS 6651, shows how a bonding plate can be seam-welded to the rebars in concrete structures, to provide a suitable surface for direct and indirect RF-bonding.

Figure 79 Example of using a bonding plate in a rebar-meshed EM Zone boundary

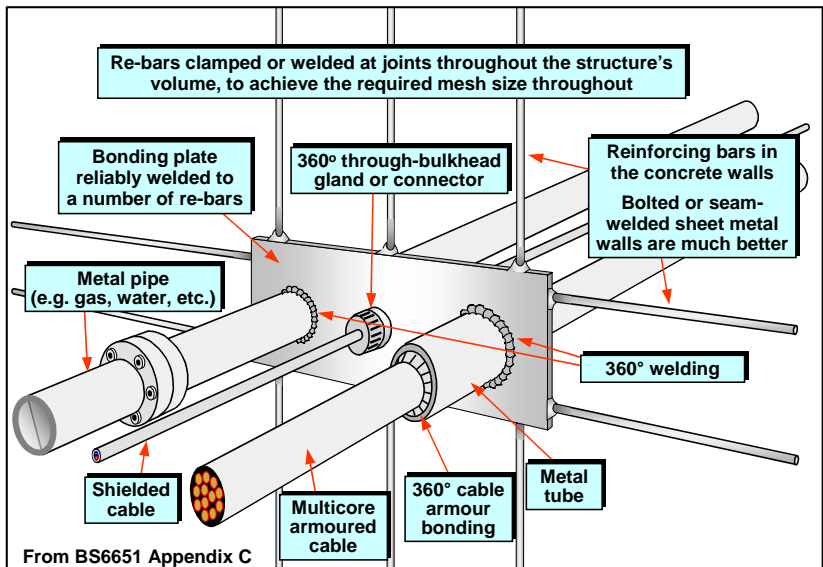

[60] recommends the use of what it calls a 'Cable Entry Vault' technique, and its figure 3-5 is replicated in Figure 80. This is a cross-sectional view of the type of construction that is recommended in the

above paragraphs for crossing an EM Zone boundary, especially the EM Zone 0/1 boundary around the external walls of the structure.

Figure 80 Example of a 'Cable Entry Vault'

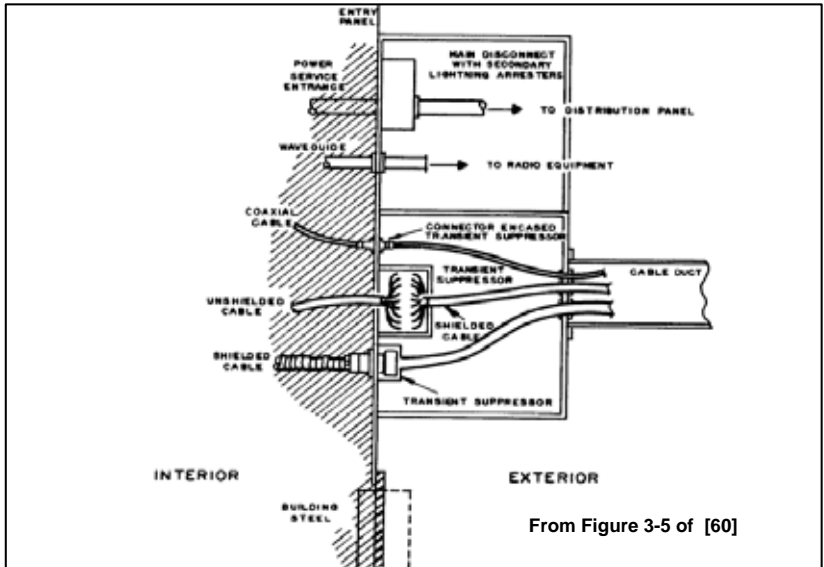

[32] describes how rebars can be used to create a very effective foundation earth electrode that is also a ring earth electrode, very suitable for a lightning protection system that is intended to protect electronics.

Good EM performance can be achieved by having the cables and other conductors entering/exiting the walls of a building (the EM Zone 0/1 boundary) via an underground 'cable entry vault' like that shown in Figure 80, using armoured cables and/or cables enclosed in a covered metal cable duct – and using the rebars shown in Figure 79 (the 'Building Steel' in Figure 80) as a 'ring earth electrode' (see 5.13.1) and also as the mesh shield for the EM Zone 0/1 boundary.

5.12.12 Non-conductors penetrating a shield

Where high-specification shielding is required, conductive liquids such as water (unless it is distilled), even if using plastic piping, are best passed through a metal pipe section one or two metres long, that is 360° RF-bonded to the shield wall as it passes through.

Non-conductors include such things as metal-free fibre-optic cables, plastic pipes for pneumatic and hydraulic systems and compressed air, and non-metallic actuators such as pull-cords or push-rods. If using a mesh shield with large enough gaps, non-conductors can simply be poked through the gaps where appropriate. But where the non-conductor is too large for this, the solution is to use a waveguide-below-cutoff technique.

The waveguide-below-cutoff technique consists essentially of a rectangular or circular metal tube that has a length that is at least four times longer than D , its longest diagonal or diameter. It maintains good SE for all frequencies below $100/D$ (D in Metres gives highest frequency in MHz, D in mm gives GHz). For example a 150mm diameter pipe 600mm long maintains very good shielding, when 360° bonded through a shield wall, at up to 670MHz. At frequencies above $150/D$ a waveguide-below-cutoff provides no SE at all.

No conductors (including conductive liquids) must ever pass through a waveguide-below-cutoff.

Any non-conductors other than air in a waveguide-below-cutoff, will decrease the frequency at which it provides good SE, so it might need to have a smaller value of D than predicted by the $100/D$ formula. Figures 5-80 to 5-86 in [60] provides some useful practical data on using this technique in shielded buildings, which is also discussed in detail in [65].

5.12.13 Doors, windows and ventilation

The mesh dimensions shown in Figures 69 to 71 are too small for use as opening doors or windows, and doors and windows are also a significant problem for any shielded volume. [65] describes the issues of doors, windows and ventilation grilles for shielding, and [36] discusses how to install them in industrial cabinets. The same principles apply for shielded volumes of any size, but their larger dimensions when used in vehicles, rooms, vessels and buildings makes them more likely to cause problems for SE.

One way to deal with windows is not to have any, relying instead on a good quality lighting system – and this is exactly what is done in some critical facilities. Removing windows also improves heat losses, removes points of weakness, and saves on window-cleaning costs.

Another approach is to make the windows non-openable, relying instead on a good quality heating ventilating and air-conditioning (HVAC) system. The concrete around the rebars in the window areas would then not be poured, and the weather kept out with glass. The rebar (or other metal) mesh would still be in place behind the glass.

Most people do not find this look attractive so architects generally design windows that are prettier, thereby creating big problems for shielding at frequencies below 10kHz. Glass with embedded wire mesh has been available for many years, and can be used for RF shielding if the wire mesh is exposed around the edges for RF-bonding to its metal frames, in turn welded to the rebars. Of course, the density of metal in a mesh-glass window is much less than in the rebar mesh, so the attenuation at 10kHz and below will be less.

For even prettier windows than wire-mesh glass, some companies can supply RFI-shielded “architectural glass” that includes thin metallised layer(s), exposed around their edges for bonding to their metal frames, for example [76]. However, the light transmittance of high-specification shielding glass might be very low.

The key to using shielding architectural glass is that its internal conductive shielding layer(s) must be brought out all

around the edge of the glass sheet, and be available for RF-bonding using suitable constructional techniques. Generally, the glass would be seated inside a metal window frame that was welded to the rebars or other mesh at numerous points around its perimeter. The conductive edge to the glass would then be RF-bonded to the metal frame using conductive EMC gaskets, or a conductive sealant (usually based on silicone), see 5.7.4. Conductive EMC gaskets are discussed in more detail in [36] and [65].

This Guide *strongly recommends* that the supply of window glass and frames, and the RF-bonding of the glass to the frame, be left entirely up to a specialist shielded glass supplier. The supplier should guarantee the overall SE performance of the glass/frame combination to the customer's specification, and prove it by EMC testing after installation.

Don't even *think* about openable shielded windows.

Doors must be openable, and also quite large, and this creates big problems for shielding. It would seem trivial to shield an ordinary door, e.g. by adding a layer of aluminium foil or cladding it with thin sheet copper or steel – but it never works because the doors are never stiff enough to compress the conductive EMC gaskets properly around their entire perimeter (see [36]). And even if the doors are made stiff enough, the tolerances of their mating with their frame are generally too large for good contact all around.

Even if the door is made stiff enough, the force required to compress the total length of gasket around the door (even very soft types that can easily be

squashed flat between two fingers) is so large that special levers and multiple latches are required. Larger doors (e.g. loading bays) often require machinery to close them properly against the resistance of the gaskets.

A shielded door must be RF-bonded all around, and this means along its bottom edge too. Whatever type of gasket is used there has to withstand foot or vehicle traffic for years, plus the dirt that accumulated on the floor and the floor cleaning that removes it. The design of shielded doors that actually work in real life, and remain effective for years, is a job for specialists.

So this Guide *very strongly recommends* that the supply of shielded doors and their metal frames, and their assembly on site, be left entirely up to a specialist shielded door supplier. The supplier should guarantee the overall SE performance of the door/frame combination to the customer's specification, and prove it by EMC testing after installation.

An important point that is easy to overlook, is that a shielded door is only shielding when it is shut. EMC test laboratories use shielded rooms to do tests, but inbetween tests they can open the shielded doors and everything is fine. But where at least modest levels of SE are required during periods in which people or vehicles need to move in and out of an EM Zone, two doors will be needed, in an 'airlock' type of arrangement so that only one can be open at any time.

Each door must achieve the full SE specification of the EM Zone on its own, and they must be connected by an extension of the EM Zone's shielding into a sort of vestibule area.

A metal tunnel that penetrates the wall of a shielded EM Zone and is large enough for people or vehicles to pass through, and 360° RF-bonded to the shield wall at the point of penetration, will create a large waveguide-below-cutoff. Its cutoff frequency will be low, because of its large diameter, but if that is sufficient for providing the SE and hence the EMC protection required for the EM Zone, then no shielded doors would be needed at all.

For example, a 3m diameter circular metal tunnel at least 12m long would maintain an SE of about 80dB at frequencies below about 30MHz. Crowding it with people could reduce its cutoff frequency to 15MHz or less, so it might be necessary to limit the rate of traffic through it.

Developing this idea further, [60] describes using a buried metal tunnel for personnel access to a shielded military facility – the depth of the soil providing good SE at frequencies above 40MHz, while the 2.5m diameter metal tunnel (360° RF-bonded to the shielded wall) acts as a waveguide-below-cutoff and provided a good SE below 40MHz. Thinking this through, they could not have extended the metal tunnel right to the surface, because that would have allowed the >40MHz EM threats to enter the waveguide. Unfortunately [60] just says that they did it, and does not describe how it was designed to achieve good SE above 40MHz.

5.12.14 Testing shielding

It is illegal to use unlicensed radio transmitters outside of an EM shielded volume, in which case shielding tests can use licensed transmitters and test at just a few frequencies. Alternatively, it is

possible to apply to the Regulatory Authority (OFCOM in the UK) for a site transmitting licence for a wide range of frequencies for a limited period.

Where an EM Zone is a high-specification shielded volume, operating an unlicensed radio transmitter inside it is permissible, because it should not be able to interfere with anything outside. Whichever side of the EM Zone boundary the transmitter is, an antenna is placed on the other side, as close as possible to the transmitting antenna when measured in a straight line.

The receiving antenna is connected to a radio receiver or spectrum analyser that is tuned to the same frequency as the transmitter. A narrow frequency span will help distinguish the transmitter's signal from the background noise, but too narrow a frequency span could cause the signal to be lost due to frequency drift between the transmitter and the receiver or spectrum analyser's frequency reference.

There are established standards that describe methodologies for performing such tests to give SE figures, and these should be used when testing a shield to see if it meets specification.

Generally, the SE of an EM Zone's shield is compromised by gaps and joints, often in unexpected locations due to poor quality control during construction. These can quickly be found by placing the transmitting antenna very close to the suspected joint or seam, for example close to a shielded door's gasket, and placing the receiving antenna at the same point on the other side. Moving them along the seam in synchronism (easier to say than do) quickly reveals places where there is excessive leakage, without any need for

calibration or accurate measurements. Such test can use a walkie-talkie, ideally one that transmits at a frequency above 200MHz.

Suitable spectrum analysers costing from £800 to £12,000 are shown in

Figure 81 – being portable they are very useful for checking shielded rooms and other potential EMC problems on a regular basis.

Figure 81 Some examples of portable spectrum analysers

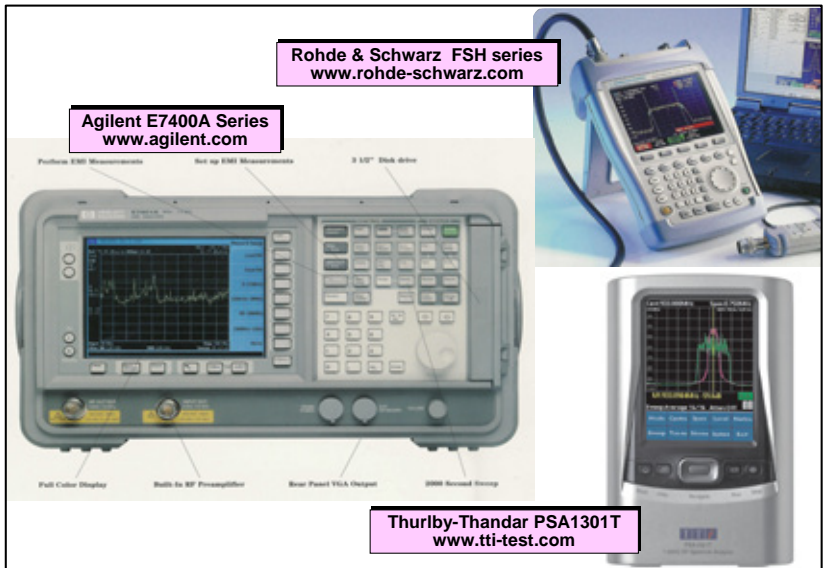

5.12.15 Shielding very low frequencies

It is difficult to shield frequencies below 100Hz. The majority of sources of EM phenomena at such frequencies are in the 'near field' and so generate low-impedance magnetic fields that ordinary materials do not attenuate very effectively.

Good shielding can be achieved from 100Hz to 10kHz by using low-carbon steel materials, but for example at 50Hz a thickness of 6.3mm only achieves an SE of about 25dB (see figure 5-14 in

[60]), assuming perfect shielding construction (seam-welded joints, etc.) as described in 5.12.8.

Special high-permeability metals (e.g. MuMetal®) are often used to avoid the need for very large thicknesses of low-carbon steel, but these are costly and require special handling. Also, they are easily saturated and so may need to be used in conjunction with steel as a two-ply or three-ply metal layered construction, for which there are proprietary types of sheet materials available from specialist suppliers.

Another technique is so-called active shielding, in which the equipment to be protected is enclosed by metal struts driven individually by currents from audio power amplifiers, in such a way that the magnetic field inside the arrangement of struts is cancelled out to a large degree. Active shielding can attenuate static (DC fields), such as the Earth's magnetic field, which 'passive' shielding with metal can never do.

Electrical power distribution is a common source of fields at 50Hz (or 60Hz in some countries) and its harmonics, and has often been found to interfere with VDUs that use cathode ray tube (CRT) technologies – especially the high-resolution types used (for example) in air traffic control.

Electron microscopes are very sensitive to magnetic fields in their environments, and the general rule is that they should be installed in areas having magnetic fields of no more than 0.1A/m. The more precision you need from an electron microscope, the lower the external fields need to be, and for example Imperial College, London, purchased a very high-specification electron microscope for which the magnetically shielded room alone cost £500,000.

It is unusual to apply shielding at sub-1kHz to an entire system – it is more usual to apply it to individual items of equipment that are especially susceptible to such fields. Since this Guide is not intended for EMC experts, it recommends that where such shielding is required, companies that specialise in providing low-frequency shielding solutions are employed.

Another problem of very low frequency magnetic fields is induced voltages in conductors. All currents travel in loops,

with an area enclosed between their send and return conductors, and these areas pick up magnetic fields in their environment and create interfering voltages. For a single current loop, in air:

$$V_n = 2 \cdot \pi \cdot f \cdot \mu_0 \cdot H \cdot A$$

where:

V_n is the noise voltage created in the signal

f is the frequency of the magnetic field (in Hertz)

μ_0 is the permeability of free space ($4\pi \cdot 10^{-7}$)

H is the magnetic field strength (in A/m)

A is the area of the loop enclosed by the circuit's current (in square metres)

For example, for a 1 square metre loop created by patient connections during evoked nerve stimulus measurements in a hospital or medical research, a 50Hz field at 0.1A/m would induce a 50Hz noise signal of 12 μ V, which could easily compromise the measurement.

Very long conductors (hundreds of metres) can suffer much larger voltages when exposed to low frequency magnetic fields, sometimes several hundred volts (e.g. lightning, EMP, etc.) – enough to damage electronics devices in some cases. However, such problems are dealt with by employing the good EMC engineering practices for cables described in this Guide, to whatever degree of detail is necessary given the importance/criticality of the application.

5.13 Surge and lightning protection

5.13.1 Applying BS EN 62305

The essential details of a Lightning Protection System (LPS) for a building are shown in Figure 82. A general description of air terminations, down-conductors and earth electrodes will be found in Chapter 9 of [32], but the primary purpose of an LPS is protecting

people from electrocution and fire, and protecting building fabrics from fire, explosion and structural damage so it is outside the scope of this Guide, for more information, see [77].

Notice that the air termination and down-conductor structure forms a mesh around the structure. Single lightning conductors, such as are often seen on old church spires, generally do not work well enough to provide adequate protection.

Figure 82 Overview of an LPS

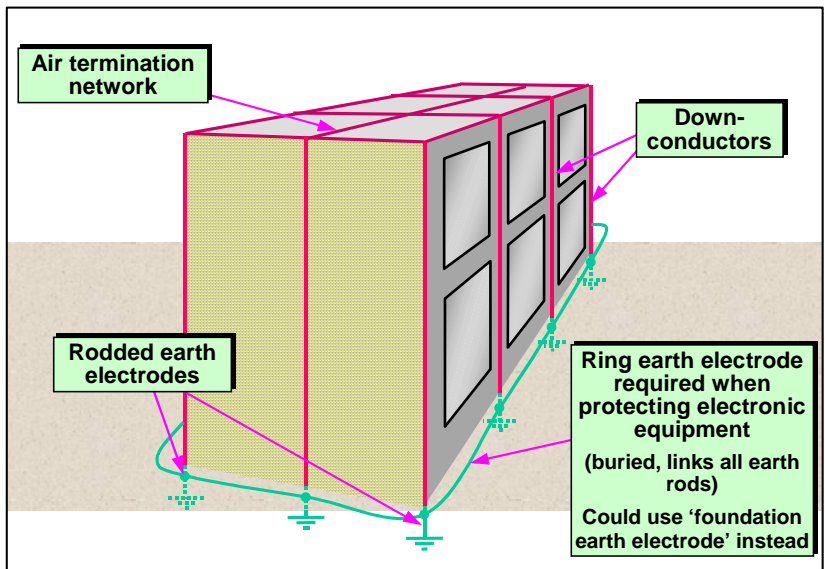

It is worth mentioning here that most lightning experts do not believe that so-called early streamer technologies work as claimed. Proponents of early streamer electrodes (ESEs) claim that they prevent lightning strikes from ‘attaching’ to a structure, and so the LPS does not need to be as robust as would

be required, for example, by [3]. This Guide is happy to go with the majority opinion and not recommend the use of early streamer technology.

As mentioned in 1.3 – from the end of August 2008 BS EN 62305:2006 [3] becomes the lightning protection standard in the UK, this describes in

great detail exactly how to analyse, design and build an external LPS. However, a great deal of additional knowledge, and calculation and/or computer simulation is required to design an LPS that achieves the required safety and protection of the building fabric, and there are very many practical issues that must also be taken into account if it is to be constructed and operate reliably for decades.

All this is best left to LPS specialists.

Some architects like to use the steel girder framing and/or rebars in the walls as the LPS downconductors, in which case it might be possible to use a meshed rebar system as discussed in 5.12.2 as an LPS too. However, in such cases it will be even more important to keep all equipment and their cables well away from the meshed structure at the boundary between EM Zones 0/1, as shown in Figure 18, to prevent high levels of stray coupling into the cables when the down-conductors carry lightning currents.

Notice that Figure 82 shows a ring earth electrode, which could be constructed from rebars in concrete foundations that are exposed to water and salts in the soil. A ring earth electrode is a sort of 'external BRC' for the earth electrodes, running around the EM Zone 0/1 boundary (which [3] calls the LPZ Zone 0/1 boundary) and connecting to each earth electrode (e.g. a driven or radial rods) in turn. A ring earth electrode is a requirement of BS EN 62305-4 whenever the risk analysis of BS EN 62305-2 shows that electronic equipment, systems or installations

inside the building should be protected from lightning.

Figures 83 and 84 show the basic features of bonding the LPS ring earth electrode to the BRC.

Figure 84 shows the main bonding bar where the conductors entering/exiting the structure are RF-bonded to the BRC around EM Zone 1, either directly or indirectly through filters, SPDs, etc. As mentioned in 4.7, this should ideally be a single small area, and Figure 80 called it a 'Cable Entry Vault'. This bonding bar or bonding plate must be connected directly to the ring earth electrode, which should also be connected to at least one earth electrode (driven or radial) at that point to ensure low impedance earth bond even for transients and radio frequencies.

Part 4 of [3] requires additional lightning protection *within* a building, to protect electronic equipment from LEMP (pulsed magnetic fields produced by lightning strikes and the currents they create in the LPS) and also from surges of voltage in all conductors, including the MESH-CBN and other metal structures.

These additional protection measures employ the same principles as have already been described in Sections 4 and 5 above:

- EM Zoning (which EN62305 calls LPZs)
- RF References
- EM mitigation
- Cable segregation/routing
- Etc.

Figure 83 Bonding an LPS to the BRC of EM Zone 1

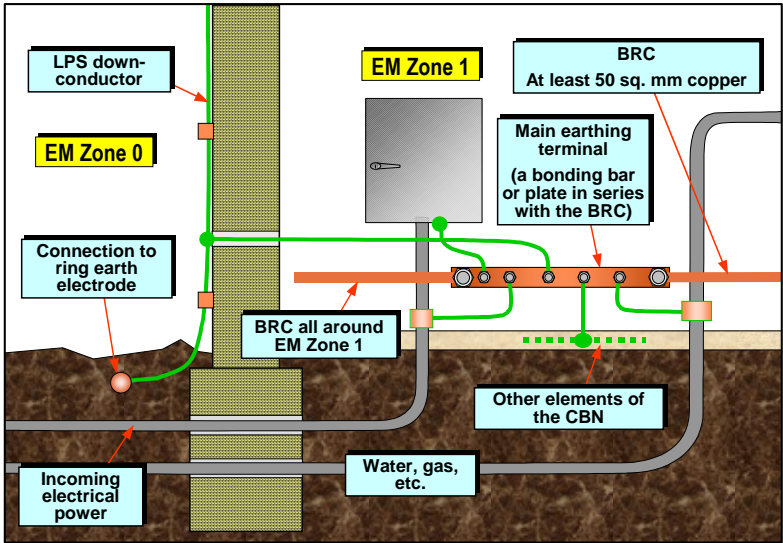
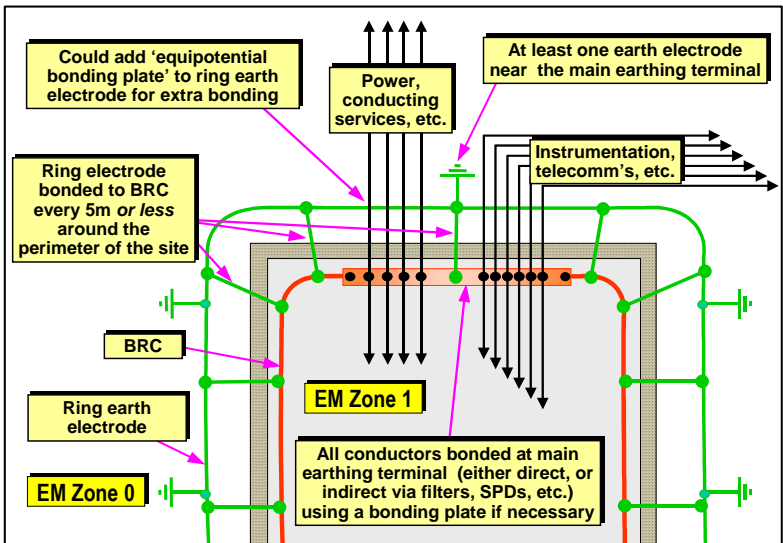

Figure 84 Meshing the ring earth electrode with the MESH-CBN of EM Zone 1



The only real difference from what has been discussed so far in this Guide is that indirect bonding at EM Zone boundaries is done using SPDs, for example where Figures 37-39, 61 and 80 show filters. But since SPDs only protect against overvoltages, to provide more comprehensive protection against EM threats at an EM Zone boundary it will generally be necessary to follow an SPD with a filter, and/or apply an SPD to the conductors in a shielded cable, all RF-bonded to the BRC using a bonding plate.

Note that the galvanic isolation EM mitigation techniques does not need to use SPDs – providing it is rated for the maximum overvoltage that could occur on its input or output, as discussed in 4.3.3.

As mentioned earlier, the centre of an EM Zone structure is generally the best place for locating sensitive or critical equipment and their cables to protect from surges and LEMP. No equipment or cables at all should be placed near an LPS air termination or down-conductor, unless they are appropriately protected against arc flashover and huge pulses of magnetic fields. Indeed, it is not recommended for people to stand near down-conductors, especially if they have been fitted with implanted electronics such as pacemakers or defibrillators.

We are talking here, about keeping *several meters* away from downconductors.

The greater the number of down-conductors, the more regularly they are spread around the perimeter of a building, and the more they share the current due to a lightning strike to the air termination network – the lower is the current in each one during a lightning

strike to the LPS. Another result of this technique is a reduction in the LEMP inside the protected structure, due to the lightning strike to the building, hence an increased volume available for sensitive electronics and their cables.

So the recommendations for numbers of down-conductors in the lightning protection standards should be taken as a minimum, and many more added where practical, to help protect electronics. Doubling the number would not be inappropriate.

Also, according to [83], the pulsed magnetic fields within a building during a lightning strike to an air termination on the roof can be “remarkably reduced” by adding a closely-spaced mesh (e.g. 2m square) onto all the roof surfaces, bonded to all the downconductors.

Such a roof mesh would have a more limited effect on a side-strike, which can happen with buildings of around 15m tall or higher, and the best that can be done to limit *their* internal magnetic fields is to add a perimeter lightning conductor, that horizontally link to all the downconductors, one for about every 15m of a building's height.

SPDs for lightning protection are split into three categories, and used as shown in Figure 85:

- *Heavy duty*: generally slow to operate but capable of handling very high currents, used on conductors crossing the boundary between EM Zones 0 and 1 (where the lightning threat is the greatest)
- *Medium duty*: fairly fast operation, not very powerful. Used at the boundary between EM Zone 1 and 2.

- Light duty*: very fast operation for the protection of electronic devices, low power. Used at the boundary between EM Zone 2 and 3, or at the metal enclosure of an item of electronic equipment if there is no EM Zone 3. Many items of equipment are supplied already fitted with appropriate light duty SPDs, for

passing tests for compliance with the EMC Directive.

Part 4 of [3] provides the specifications for each types of SPD, requiring them to pass tests in other IEC standards. These tests subject the SPDs to representative surges, and they repeat the tests a specified number of times to ensure that they will be robust enough for reliable operation in real life.

Figure 85 Zoning and SPDs

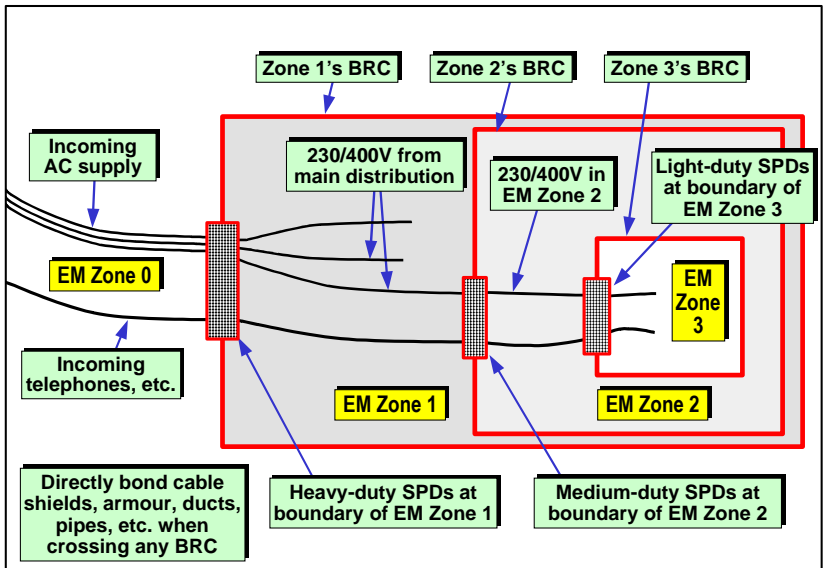

Where other kinds of surges are to be suppressed (see 5.13.5) the SPDs might need to have additional performance, or additional types of SPDs might need to be employed.

Figures 86 and 87 show just a few of the very many types of SPDs that are commercially available from a number of suppliers. Wired-in or leaded SPDs are used for protection of mains supplies,

and also for signals, controls and data that can be connected by screw-terminals, such as 'plain old' telephones. Some types of signals or data require shielded wires, though, and there are types of SPDs designed to suit them too, Figure 87 includes some examples.

Figure 87 also shows a small group of SPDs mounted on a bonding plate at an EM Zone boundary.

Figure 86 Some types of SPDs

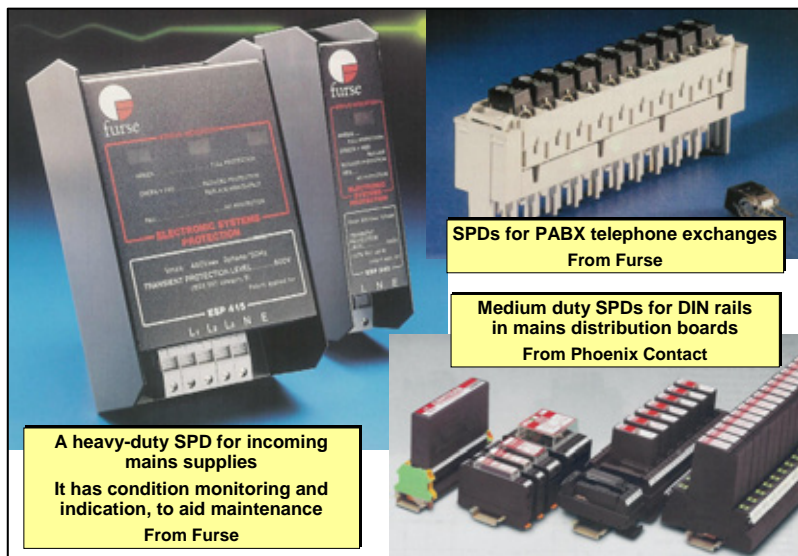
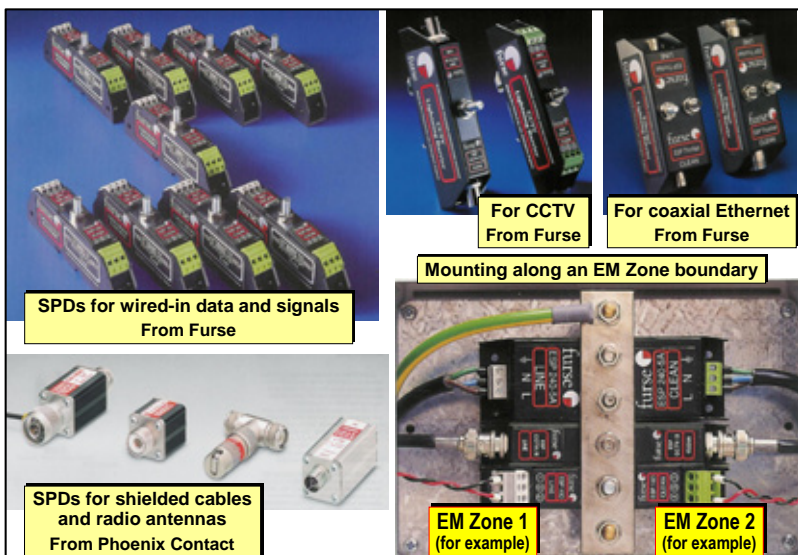

Figure 87 Some more types of SPDs



5.13.2 Data needs error detection/correction

SPDs on data lines only protect the electronics from damage; they do not prevent false data from occurring during a surge or similar transient overvoltage event.

Where false data could cause a problem, data lines exposed to surges also need to use an error-detecting or error correcting protocol, for example as used by Ethernet or CAN bus. The MIL-STD-1553 bus is an example of a very robust real-time data bus, and commercial versions are now available.

5.13.3 Magnetic pulse immunity requirements for items of equipment

[3] also includes requirements for the immunity of items of equipment. Specifically, it requires that electrical and electronic equipment identified by its risk assessment process as being in need of protection from lightning, must have an appropriate level of immunity to transient magnetic fields, as tested using IEC 61000-4-9 ("Pulse Magnetic Field Immunity Test") and/or IEC 61000-4-10 ("Damped Oscillatory Magnetic Field Test").

Equipment that meets higher levels on these tests needs less shielding from lightning electromagnetic pulse by the meshed metal structures and other conductors in the building structure (see 5.12).

Unfortunately, tests to IEC 61000-4-9 and -10 are not required by the generic or product standards that are listed under the EMC Directive. Presumably, this omission is because the EMC Directive is only concerned with "normal operation", and lightning is apparently

not considered to be 'normal', even though it occurs within 3 miles (5km) of most places, in most years.

Also, the generic and product standards listed under the EMC Directive only test with conducted surges at no more than $\pm 2\text{kV}$. However, it is an observed fact that normal 230V AC rms single-phase mains distribution networks that are not protected by appropriate surge protection devices, will experience surges up to $\pm 6\text{kV}$ – the voltage at which the terminals in the wall-sockets spark over. This much higher level of real-life surge is reflected in the specifications in the power quality standard for European mains voltage [22].

Once again, it seems that this is not addressed by EMC Directive Standards, probably because such large surges are not considered to occur in 'normal' operation, even though several can be expected in a typical year. Where mains power is provided to a building by overhead cables, possibly several hundred times each year.

The above means that items of equipment identified by the risk assessment process in [3], as requiring protection from the effects of lightning, should be purchased against a contract specification that includes requirements for passing tests to IEC 61000-4-9 and IEC 61000-4-10, at specified levels that are related to the degree of magnetic shielding provided by (or are planned for) the building's structure, derived from calculations in BS EN 62305-4.

Also the purchasing contract should include specifications for passing tests to IEC 61000-4-5 ('unidirectional surge'), IEC 61000-4-12 ('ring wave surge') and/or IEC 61000-4-18 ('damped oscillatory wave surge'), at levels that

correspond to the degree of conducted surge suppression that will be provided by (or are planned for) the electrical installation, for AC mains power and also for cables carrying signals, control or data that are longer than 30 metres.

Where critical equipment has unknown or inadequate immunity to magnetic pulses or voltage surges, the design should provide a high degree of protection, consistent with the consequential risks of damage to the equipment as determined by a risk analysis such as the one in Part 2 of [3].

Where the financial consequences of equipment errors, malfunctions or failure are very severe, and/or where they could increase human safety risks (see 2.2), the appropriate specification of equipment to withstand LEMP within a given building is a very important issue – it certainly will not be sufficient to rely on the equipment's CE-marking or compliance with the EMC Directive.

The need to co-ordinate the LEMP shielding and surge protection of an installation, with the pulsed magnetic field specifications of the equipment (to IEC 61000-4-9/10) to be used within that installation, is comprehensively ignored at the time of writing.

I imagine it will continue to be ignored until a series of very costly electronic failures (possibly with safety implications, e.g. hospitals) due to a major thunderstorm tracking across the country, wakes-up the insurance companies.

5.13.4 HPEM: High Power Electromagnetic Environments

HPEM includes any environment where the incident field exceeds 100V/m, and

there are now a number of IEC standards dealing with types of HPEM and their effects, HPEM environments, testing and measurements techniques, installation and mitigation guidelines, and even a generic standard, all listed with their scopes in [78]. Lightning is of course an HPEM, but for civilian buildings is covered by [3] and there are other standards for military vehicles and aerospace.

HPEM environments include Nuclear EM pulse (NEMP), high-altitude EM pulse (HEMP) and other EMPs, that are the dominant effects (outside of the thermal and blast radius) of a nuclear bomb – from the point of view of an electronic device – and can damage electronic equipment at hundreds of miles distance [60] [79]. Their EM threats are superficially similar to lightning, but up to 10,000 times faster with a frequency spectrum extends to 100MHz – so protection methods suitable for lightning will probably not be enough.

EMP is outside the scope of this Guide, although information and guidance on it is readily available in military and civil defence publications and textbooks in the public domain. It is an increasing concern when considering data security, terrorism, and criminal activities, since it seems that EMP 'bombs' which create little blast damage can be made without too much difficulty [80].

Protecting against EMP is a matter of applying the techniques discussed in this Guide in an appropriate manner, depending on the nature of the EM threat. For more on how to do this refer to [60], which also has a comprehensive list of references for further study.

5.13.5 Other external and internal surges

Externally generated overvoltage surges, other than those caused by lightning, are especially common on incoming HV or MV power supplies. They are caused by the switching of large reactive loads, or load shedding by HV or MV switchgear or in the wider distribution network. External non-lightning surge sources also afflict telephone and data lines outside structures, usually due to shorting to mains cables when a vehicle knocks down a utility pole, or when a mechanical digger cuts through an underground cable conduit (sometimes called a 'power cross').

Very large currents from HV or MV earth faults can damage (even vaporise) signal or data cables that connect to a different building, and/or damage the equipment they interconnect. Even fibre-optic cables may not be immune to this if they use metal in their construction, unless any metal in them is stripped back far enough before entering the structure (generally, by at least 2 metres).

Internal surges can be caused by large on/off controlled DC or AC motors as their stored energy is released at switch-off, by the opening of a fuse (peak voltage typically double the peak of the nominal supply voltage), and by faults in the power distribution network. At the more extreme end, a superconducting magnet in an MRI scanner or linear accelerator can source around 1MJ of surge energy when its field collapses.

Internally-generated surges are best controlled by segregating high power and sensitive equipment and their cables

and power supplies as described in 4.6, and providing a good low-impedance MESH-CBN (or a number of MESH-IBNs). But where surges originate *within* an EM Zone it may be difficult to stop the other equipment in the zone from being exposed, and either a nested EM Zone should be created, or appropriate SPDs or filters applied to the offending equipment. Galvanic isolation is another useful technique in such situations (see 4.3).

Where significant non-lightning surges exist, the lightning exposure levels that were determined by the risk assessment methodology in [3] (or equivalent) may need to be increased, requiring upgrades in one or more of the lightning protection measures discussed above.

As mentioned earlier, data security and the reliability of electronics is an increasing concern as our society comes to entirely depend upon data and electronics, [79] [81]. The military have a powerful zone protection programme known as TEMPEST. This is now available for civilian use to counter the increasing amount of commercial, financial, and industrial blackmail, terrorism, and espionage which relies upon the vulnerability of modern computers and their networks to EM disturbances, and their propensity to broadcast their data over large geographical areas where they may be picked up by sensitive receivers available to all.

Mains filters for TEMPEST tend to have many more than two stages, and reliably provide over 80dB of attenuation from 10kHz to over 1GHz. Shielding for TEMPEST tends to be similar to that used for EMC test chambers. I understand that UK national security operatives nowadays are expected to work in EMC shielded rooms such as the one in Figure 72, with only a single metal conductor – the mains cable – that enters through a very large TEMPEST filter. All data in or out of the room is carried by metal-free fibre optics, presumably with sensitive devices to monitor optical signal levels for taps. I hope that they remember to shut the doors to their rooms when they are working.

Whilst the level of protection provided for the offices of spies may be excessive for most situations, merchant banks and the like that handle billions of dollars of trade

ever day (or more) stand to lose many 10s of millions due to a single downtime incident lasting a few hours, never mind an actual espionage or e-terrorism incident. For such enterprises, as for nuclear control rooms, financially justifying an adequate level of protection from all but the most extreme of EM threats is probably not difficult to do, especially at the planning stage where the measures required can be designed-in at much less cost than adding them after construction is complete.

There is increasing concern that national power grids and other infrastructures are vulnerable to a number of EMI events caused by solar storms [84], criminals and terrorists [79] [80] [81] [85] [86].

[84] warns that a repeat of the 1859 solar outburst known as the “Carrington Event” would have a similar effect as the EMP attacks that are the concern of [79] [85] and [86]. In either case, studies show that the USA’s national power grid could be out of action for several years, causing a “complete breakdown of civil society”. Similar conclusions apply to other countries’ power grids, and to many other kinds of national infrastructure, such as wired telephone networks, electrified railways and the like.

Of course, because such an incident has not yet occurred, most people like to *pretend* that it never will – when in reality it could happen tomorrow, with almost *unimaginably severe* consequences for any developed country.

All of the techniques described above rely for their effectiveness on achieving very low-impedance RF-bonds over the operational life, despite its physical and climatic environments. The contact resistance at each RF-bond must not be permitted to increase too much over the lifecycle, either due to fretting, or oxidation or other chemical conversion of the metals or conductors used, or due to galvanic corrosion.

Fretting corrosion is a form of accelerated atmospheric oxidation that occurs at the interface of conducting materials undergoing slight, cyclic relative motion. In electrical contacts involving non-noble metals, fretting action can cause rapid increases in contact resistance, even creating open circuits in a matter of *minutes* in extreme cases [82].

Oxidation always occurs on the surfaces of metals that are exposed to gasses or liquids containing air (or at least oxygen), and metal oxides are either non-conducting or semi-conducting, both of which are bad for electrical contacts and RF-bonds. In the case of iron, most steels, and aluminium the oxides are very tough, and their thickness will almost always build up to such an extent that reliable electrical connections and RF-bonding cannot be ensured.

There are situations where installations are operated in the absence of oxygen (e.g. in space, or where explosive atmospheres could occur and protection is achieved by using electrical/electronic cabinets fed with pure nitrogen at a pressure above atmospheric), but

otherwise most equipment and installations suffer oxidation.

To prevent EMC problems due to oxidation we use metals that have very thin, weak oxides, easily penetrated by the kind of contact pressures we will be applying at electrical contacts and RF-bonds in our installation. Since the best RF-bonds use an area contact, rather than a point contact (see 5.7.1 and Figure 29) the issue of the type of oxide and the surface pressure is often critical. Where suitable metals are not very strong, we use them as plating on top of stronger metals, so that the plating makes the electrical connection or RF-bond, whilst the metal underneath the plating provides the strength and is protected from oxidation.

Gold is the best metal to use for reason of its very weak and thin oxide, but unfortunately it is too costly for general use as a structural material, and even too costly to be used for plating other than small areas.

In some more-polluted atmospheres, chemical conversions of metal surfaces can occur in a similar way to oxidation. For example, where there are significant amounts of sulphurous gasses and vapours, such as near fossil-fuel burning engines (e.g. electrical power generating station; roads for motor vehicles; residential areas where coal burning is permitted etc.) there will be sulphides and/or sulphates created. Like oxides, they are non-conductors or semi-conductors, and also bad for EMC. Silver is a good contact material, but it easily corrodes to a sulphide, and

blackened silver is a common sight. So silver is a poor finish.

Galvanic corrosion is a different corrosion mechanism from oxidation or similar chemical conversion mechanisms described above. It arises because different metals have different positions in the electro-chemical series, so when connected by an electrically-conductive liquid (called an electrolyte, for example ordinary water) they form an 'accidental battery' and a self-generated current flows in them. The most anodic of the metals gets eaten away by this current,

eventually disappearing (or turning into non-conductive or semi-conductive corrosion products) altogether. If the choice of metals is poor for the environment, galvanic corrosion can completely destroy an electrical connection or RF-bond very quickly indeed, maybe in just a few weeks.

Figure 88 shows an example of a simulated lifecycle test using standard metal blanks to test the galvanic compatibility of different types of conductive EMC gasket.

Figure 88 Example of a test comparing simulated lifecycle corrosion for three different gasket types

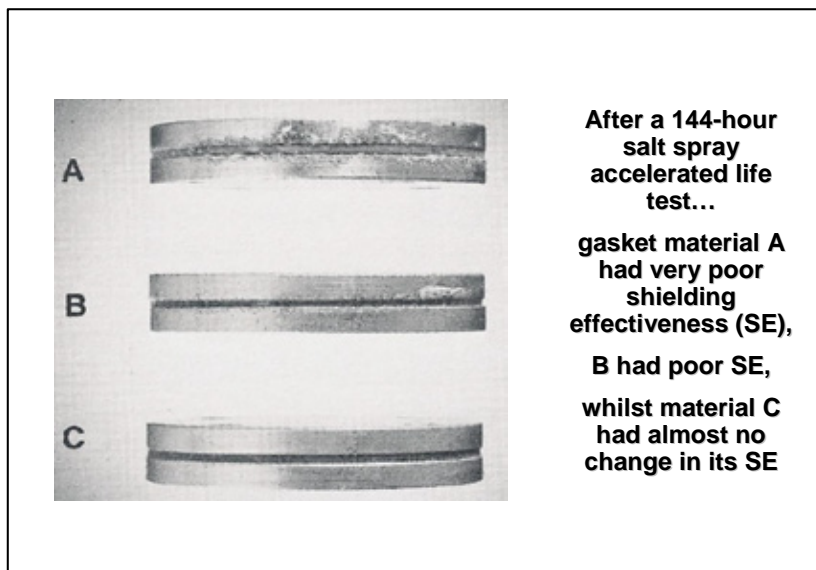

[45] has a very good chapter on preventing galvanic corrosion, which is summarised very briefly below.

Metals are generally classified by their position in the 'galvanic series', into five

categories as shown below in order from most anodic (more easily corroded) to most cathodic (least easily corroded)

Group 1	Magnesium	Most easily corroded
Group 2	Aluminium and its alloys, zinc, cadmium	
Group 3	Carbon steel, iron, lead, tin, tin-lead solder	
Group 4	Nickel, chromium, stainless steel	
Group 5	Copper, silver, gold, platinum, titanium	Least easily corroded

The idea behind this categorisation is that the galvanic voltage differences between the materials within a given Group are low enough to allow them to be used in contact with each other regardless of the environment. However, in very aggressive environments (such as the deck of an ocean-going vessel) it is probably best to make sure that only identical metals (or, if they are alloys such as brass, identical compositions) are used in contact.

Coating or plating mating parts with the same metal (for example, zinc, tin, or nickel) helps keep the dissimilar metals protected from the electrolyte, preventing galvanic corrosion, but depends on the quality of the plating. A pinhole or scratch in the plating can allow the metal underneath the plating to get eaten away.

The flow of DC or AC current through an electrical bond also hastens galvanic corrosion, making it a more important consideration for MESH-CBNs and the like, where currents flow in metalwork. Rebars can suffer badly from corrosion unless appropriate care is taken. It is always best to ensure that the part that is more easy to replace, is either the same metal as the other part, or is higher in the galvanic series and so more likely to be the part that corrodes.

Figure 89 is a useful table giving guidance on the combinations of the metals in the above five groups, depending on their environment, and was copied from [45]. It also includes some recommendations for protecting joints, for example by coatings (grease is a favourite).

Figure 89 Corrosion guidance

Exposure situation	Anodic end (most heavily corroded)				Cathodic end
	Group 1	Group 2	Group 3	Group 4	
Exposed	B	A	n/a	n/a	Group 2
Sheltered	A	A	n/a	n/a	Group 2
Protected	A	A	n/a	n/a	Group 2
Exposed	C	B	A	n/a	Group 3
Sheltered	C	A	A	n/a	Group 3
Protected	B	A	A	n/a	Group 3
Exposed	No	C	B	A	Group 4
Sheltered	C	B	A	A	Group 4
Protected	C	A	A	A	Group 4
Exposed	No	No	C	B	Group 5
Sheltered	No	B	B	A	Group 5
Protected	C	B	A	A	Group 5

KEY: No = Do not use this combination

From NAVAIR115

A = Metal may be exposed at junction surfaces

B = Coating *must* prevent any possibility of liquid bridging the joint

C = Protective coatings mandatory, but joint may still have a short life

Section 5 of [60] also has some useful advice on preventing galvanic corrosion, and points out that dust and dirt that accumulates tends to absorb moisture, where it becomes an attractive substrate for moulds and fungi, which retain more moisture. So even in dry indoor environments galvanic corrosion can still occur.

Welded joints and seams do not corrode, and cadwelding allows dissimilar metals (e.g. copper and steel) to be thermally welded, removing their potential for galvanic corrosion.

Vapour-phase corrosion inhibition is a recently developed technology [64] that claims to use small quantities of a solid material that sublimates, releasing a vapour that coats nearby metal parts with an insulating film just a few

molecules thick. The film is supposed to be so weak that any pressure will penetrate it and allow good electrical contacts and RF-bonds to be made, but sufficiently impervious to oxygen and liquids to prevent oxidative or galvanic corrosion. It can be used as an admixture in concrete, to protect rebars from rusting over decades.

EM performance always degrades over time, due to corrosion, vibration, movement of structures, wear of conductive gaskets at doors, etc., so it is a good idea to overspecify the EMC requirements during the project design to allow for this (see 5.2), and to design and construct the vehicle, vessel, building, site, installation, etc. so that its EM characteristics will be reliable over time (e.g. using welded instead of bolted joints).

However, without appropriate maintenance activities, any installation will eventually lose an unacceptable amount of EM performance, for instance by misuse (e.g. people leaving shielded doors open).

So part of the design process (see 5.2) is to:

- Identify all the areas that will need maintenance.
- Specify the periodicity of the maintenance activities for each item (some may be annual, some every 5 or 10 years).
- Specify exactly how inspection is to be accomplished (e.g. by visual inspection, measurement, etc.).
- Specify what is considered unacceptable.
- Specify how refurbishment is to be done.

This exercise concentrates the mind wonderfully during design, and can lead to the realisation that the design needs to be done in a particular way to enable all critical points to be easily monitored,

possibly leading to major savings in cost over the operational lifetime.

Some examples of common EMC maintenance activities follow, but this is not a comprehensive list.

- Any shielded doors, and shielded panels that are frequently removed and replaced, are prime candidates for annual inspections. Gaskets should be inspected and any suspect lengths replaced with new. Spring finger gaskets generally benefit from a light coating of petroleum jelly, to reduce fretting corrosion at sliding contacts.
- SPDs have in the past had a tendency to degrade rapidly, although the new IEC standards referenced in [3] should make them more reliable. But thunderstorm activity is hard to predict and they might reach their design life in one-quarter the expected time, or less. SPDs are increasingly being designed with built-in performance monitoring, and some even with signal outputs that can be monitored by a remote computer.
- Filters can be degraded by surges, vibration and overheating/overloading, and like SPDs that have no built-in condition monitoring they need some kind of performance test to see if they are still doing the job that was expected of them.
- All non-welded RF-bonds may need disassembly every few years, cleaning and reassembly, according to Chapter 5 of [60].

- Any joints that are exposed, or otherwise likely to corrode (see Figure 89) should be regularly inspected and their protective greases or other coatings renewed, at least. Disassembly might be required to check for corrosion.
- MESH-IBNs (see 5.5.5) must be regularly checked to ensure they have not lost their 10kV isolation.
- When using existing (so-called 'natural') metalwork and/or cable armour as part of a CBN, or as a PEC, as shown in Figure 23, the installation should be managed to ensure that all joints and connections remain bonded over the lifecycle, and that no-one disconnects any part (e.g. by adding a junction box to an armoured cable) during any modifications or additions to the system or installation. Cable support structures and armour are usually assumed to be simply for mechanical protection purposes, so when they are used to improve EMC performance, any/all work that could affect them should be supervised carefully.
- Repairs, refurbishment, upgrades, modifications and additions to an installation must not degrade its EMC performance. This is a problem where any computer board or module has to be replaced, because it is almost certain to be replaced with a much more powerful unit – the old one having gone obsolete within a year of the original construction. Of course, the new boards/modules will have different EMC performance.

[1] European Union Directive 2004/108/EC (as amended) on Electromagnetic Compatibility (2nd Edition) in English: http://eur-lex.europa.eu/LexUriServ/site/en/oj/2004/l_390/l_39020041231en00240037.pdf

in any EU language:

http://ec.europa.eu/enterprise/electr_equipment/emc/directiv/dir2004_108.htm

The Directive's official EU homepage includes a downloadable version of the current EMC Directive and its successor; a table of all the EN standards listed under the Directive; a guidance document on how to apply the Directive; lists of appointed EMC Competent Bodies; etc., all at:

http://europa.eu.int/comm/enterprise/electr_equipment/emc/index.htm.

[2] IEC 60364-4-44:2006 *“Electrical installations of buildings – Part 4-44: Protection for safety – Protection against voltage disturbances and electromagnetic disturbances”*, Clause 444: “Measures against electromagnetic influences”

[3] BS EN 62305:2006, *“Protection Against Lightning”*, in four parts. It is identical to EN 62305:2006 and also to Parts 1, 2 and 4 of IEC 62305:2006. BS EN 62306-3 is essentially the same as IEC 62305-3, except for some common modifications.

[4] The EMC Regulations 2006, United Kingdom Statutory Instrument 2006 No. 3418:

http://www.opsi.gov.uk/si/si2006/uksi_20063418_en.pdf

[5] The IET's 2008 *“Guide on EMC for Functional Safety”*, free download:

www.theiet.org/factfiles/emc/index.htm or from the ‘Publications & Downloads’ pages at www.cherryclough.com, or as low-cost colour-printed book from <http://www.emcacademy.org/books.asp>

[6] *“List of Resources on EMC for Functional Safety”*, Keith Armstrong, from the ‘Publications & Downloads’ pages at www.cherryclough.com

[7] *“Reducing Risks, Protecting People”*, the Health & Safety Executive (HSE) 2001, HSE Books, ISBN 0 7176 2151 0, available from www.hsebooks.co.uk. The ‘HSE InfoLine’ is another source of information, via www.hse.gov.uk.

[8] The EC's official guide on 2004/108/EC:

http://ec.europa.eu/enterprise/electr_equipment/emc/guides/emcguide_may2007.pdf

[9] The UK's official guide to the 2006 EMC Regulations, August 2008: either via:

<http://www.berr.gov.uk/whatwedo/sectors/sustainability/regulations/ecdirect/page12469.html>,

or download from:

<http://www.berr.gov.uk/files/file47539.pdf>

[10] The EC's ‘Blue Guide’, *“Guide to the Implementation of Directives Based on the New Approach and the Global Approach”*, 2000:

<http://ec.europa.eu/enterprise/newapproach/legislation/guide/index.htm>, also (English only) from:

http://ec.europa.eu/enterprise/newapproach/legislation/guide/document/1999_1282_en.pdf

[11] The Product Liability Directive, 85/374/EEC amended by 99/34/EC,

implemented in the UK as the Consumer Protection Act 1987,

<http://europa.eu/scadplus/leg/en/lvb/l32012.htm>,

<http://www.dti.gov.uk/files/file22866.pdf>

[12] IEC 61508: “*Functional Safety of Electrical, Electronic and Programmable Electronic Systems*” (seven parts)

[13] IEC 61511: “*Functional safety: Safety instrumented systems for the process industry sector*”

[14] IEC 62061: “*Safety of Machinery – Functional safety of electrical, electronic and programmable control systems for machinery*”

[15] The ‘Machinery Safety Directive’: “*Directive 98/37/EC of the European Parliament and of the Council of 22 June 1998 on the approximation of the laws of the Member States relating to machinery*”

The new Machinery Safety Directive: “*Directive 2006/42/EC of the European Parliament and of the Council of 17 May 2006 on machinery, and amending Directive 95/16/EC (recast)*”

[16] The consolidated version of the Low Voltage Directive, 2006/95/EC, replaces 73/23/EEC and its amendment by 93/68/EEC, http://europa.eu.int/comm/enterprise/ele_ctr_equipment/lv/index.htm

[17] IEC TS 61000-1-2, basic safety publication, Ed. 2.0, December 2008, “*Electromagnetic Compatibility (EMC) – Part 1-2: General – Methodology for the achievement of the functional safety of electrical and electronic equipment with regard to electromagnetic phenomena.*”

[18] “*CE + CE does not equal CE – what to do instead*” available from the ‘Publications and Downloads’ pages at www.cherrycloud.com

[19] From the BERR/EMCTLA/EMCIA meeting held at the Newbury Hilton, 29th Nov 07, at which BERR’s EMC consultants responded to a series of questions about how to interpret the UK’s 2006 EMC Regulations.

[20] “*The Future of Market Surveillance for Technical Products in Europe*”, Ivan Hendrikx, Conformity, Apr 1, 2007, www.conformity.com.

[21] “*The First 500 Banana Skins*”, Nutwood UK, 2007, from <http://www.emcademy.org/books.asp>. This amazing little book summarises 500 published reports and anecdotes on interference events, and costs about £10. It can also be read online (not downloaded) at www.theemcjournal.com by clicking on ‘EMC Information Centre’ (registering if necessary) then clicking on ‘Banana Skins’.

[22] BS EN 50160:2000, “*Voltage characteristics of electricity supplied by public distribution systems*”

[23] “*Combined Effects of Several, Simultaneous, EMI Couplings*”, Michel Mardiguian, 2000 IEEE International Symposium on EMC, Washington D.C., August 21-25 2000, ISBN 0-7803-5680-2, pp. 181-184

[24] “*EMC Performance of Drive Application Under Real Load Condition*”, F Beck and J Sroka, Schaffner EMV AG application note, 11th March 1999

[25] “*The Case for Combining EMC and Environmental Testing*”, W H Parker, W Tustin, T Masone, ITEM 2002, pp 54-60 <http://www.interferencetechnology.com>

[26] “*Breaking All the Rules: Challenging the Engineering and Regulatory Precepts of Electromagnetic Compatibility*”, D A Townsend et al, 1995 IEEE International Symposium on

Electromagnetic Compatibility, Atlanta, 1995, pp 194 – 199.

[27] BS EN 55011:2007 (CISPR11 Am2 Ed. 4.0:2006) "*Industrial, scientific and medical (ISM) radio-frequency equipment - Electromagnetic disturbance characteristics - Limits and methods of measurement*". The scope of this standard includes: Interference relating to industrial, scientific and medical radio-frequency apparatus, other (high power) industrial equipment, overhead power lines, high voltage equipment and electric traction. At the time of writing the 5th Edition of CISPR11 has been finalised and will be published very soon.

[28] DD CLC/TS 50217:2005, "*Guide for in situ measurements – In situ measurements of disturbance emission*", Cenelec Technical Specification CLC/TS 50217:2005, published by British Standards Institution as a draft for development (DD). A Technical Specification (TS) is not a standard, but it is considered to be a proposal for a standard that needs further experience with its use before a final version could be agreed. However, in the absence of a relevant standard, a TS can be used as an expression of the present state-of-the-art for the issues within its scope.

[29] REO Guide on EN 61000-3-3 and -3-11, "*Emissions of voltage fluctuations and flicker*", from www.reo.co.uk/knowledgebase

[30] "*Complying with the EMC Directive (2004/108/EC) Second Edition*", Keith Armstrong, Conformity, March 2008, pp 12-23, www.conformity.com.

[31] "*Electromagnetic Compatibility in Heavy Power Installations*", IEE Colloquium, Middlesborough UK, 23rd

February 1999, IEE Colloquium Digest No. 99/0666 (ISSN 0963-3308) available from IEE Sales for around £20, sales@iee.org.uk or from the IEE Library: www.iee.org.uk/Library, libdesk@iee.org.uk

[32] "*EMC for Systems and Installations*", Tim Williams and Keith Armstrong, Newnes, 2000, ISBN 0 7506 4167 3, RS Components Part No. 377-6463

[33] A number of useful and practical documents on complying with the EMC Directive are available from the 'Publications and Downloads' pages at www.cherryclough.com

[34] REO (UK) Ltd Guide on "*Harmonics*", available from www.reo.co.uk/knowledgebase.

[35] REO Guide on "*Power Quality*", available from www.reo.co.uk/knowledgebase.

[36] REO Guide on "*Good EMC Engineering Practices in the Design and Construction of Industrial Cabinets*", available from www.reo.co.uk/knowledgebase

[37] Seventeen EMC Guides on EM phenomena, legal compliance and EMC testing have been written by Keith Armstrong and published by REO (UK) Ltd. They are very readable and practical, and can be downloaded from www.reo.co.uk/knowledgebase. They are also available from REO (UK) Ltd and Cherry Clough Consultants [48] as a CD-ROM that contains all 17 of them plus other REO EMC Guides and a great deal of other useful information on EMC.

[38] Def Stan 59-411 "*Electromagnetic Compatibility*", from: <http://www.dstan.mod.uk/> (you will need to register first)

Part No: 1: "Management & Planning"
 Part No: 2: "The Electric, Magnetic and Electromagnetic Environment"
 Part No: 3: "Test Methods and Limits for Equipment and Sub Systems"
 Part No: 4: "Platform and System Tests and Trials"
 Part No: 5: "Code of Practice for Tri-Service Design and Installation"

[39] "Assessing an EM Environment", Keith Armstrong, EMC Test Labs Association (www.emctla.co.uk) Technical Guidance Note No. TGN 47, also available from the 'Publications and Downloads' pages at www.cherryclough.com

[40] "EMC Testing", a series in six parts by Tim Williams and Keith Armstrong, published in the EMC Compliance Journal during 2001-2, and available via the 'Publications and Downloads' pages at www.cherryclough.com

[41] "On-Site EMC Test Methods", Keith Armstrong, EMC Test Labs Association (www.emctla.co.uk) Technical Guidance Note No. TGN 49, also available from the 'Publications and Downloads' pages at www.cherryclough.com

[42] "Achieving EMC Directive Compliance with a Spreadsheet", Keith Armstrong, Conformity, February 2006, from archives at www.conformity.com

[43] IEC 61000-5-2:1997 "Electromagnetic Compatibility (EMC) – Part 5: Installation and Mitigation Guidelines – Section 2: Earthing and cabling"

[44] PD IEC TR 61000-5-6:2002 "Electromagnetic Compatibility (EMC) – Installation and mitigation guidelines – Mitigation of external EM influences"

[45] NAVAIR AD 115 "Electromagnetic Compatibility Design Guide for Avionics

and Related Ground Equipment", 3rd Edition, June 1988, Naval Air Systems Command, Department of the Navy, Washington DC, USA.

[46] "Electromagnetic Compatibility – Installation Guide", Eurotherm Controls, http://download.eurotherm.co.uk/downloads/DL/EMC_025464_1.pdf

[47] "EMC: Electromagnetic Compatibility", Jacques Delaballe, Schneider Electric, www.schneider-electric.com/cahier_technique/en/pdf/ect149.pdf

[48] Keith Armstrong, Cherry Clough Consultants, www.cherryclough.com, keith.armstrong@cherryclough.com, telephone: +44 (0)1785 660 247

[49] "Design Techniques for EMC- Part 2: Cables and Connectors", Keith Armstrong, The EMC Journal May 2006 (Issue 64) pages 31-41 and July 2006 (Issue 65) pages 25-38, available from www.compliance-club.com (search by 'Keith Armstrong')

[50] ETSI EN 300 253 V2.1.1 (2002-04) "Environmental Engineering (EE); Earthing and bonding of telecommunication equipment in telecommunication centres", www.etsi.org

[51] BS EN 50174-2:2001 "Information technology. Cabling installation. Installation planning and practices inside buildings"

[52] International Telecommunication Union (ITU) Recommendation K.35 (1996): "Bonding configurations and earthing at remote electronic sites", www.itu.int

[53] BS EN 50310:2006 "Application of equipotential bonding and earthing in buildings with information technology equipment"

- [54] *"Bonding Cable Shields at Both Ends to Reduce Noise"*, Tony Waldron and Keith Armstrong, EMC + Compliance Journal, May 2002, pages 14-27, available via the 'Publications & Downloads' page at www.cherryclough.com.
- [55] *"Audio-frequency screen current induced noise is negligible (as long as it is prevented from flowing in the OV)"*, Keith Armstrong, Audio Engineering Society workshop on "Bonding and Grounding", Amsterdam, 23 March 2003, available via the 'Publications & Downloads' page at www.cherryclough.com.
- [56] *"The Benefits of Applying IEC 61000-5-2 to Cable Shield Bonding and Earthing"*, available via the 'Publications & Downloads' page at www.cherryclough.com in two versions, one intended for professional audio, and one for general industrial and information technology applications as presented at the IEE's colloquium on *"EMC, its all about the cables"*, Savoy Place, London, UK, 22nd January 2003 and again at the IEE's workshop *"Its all about the cables"* at Euro-EMC 2004, Eindhoven, Sept 6-10 2004.
- [57] BS EN 50174 *"Information technology – Cabling installation"*
 Part 1: "Specification and quality assurance"
 Part 2: "Installation planning and practices inside buildings"
 Part 3: "Installation planning and practices outside buildings"
- [58] *"EMC Analysis Methods and Computational Models"*, F M Tesche, M V Iano and Torbjorn Karlsson, John Wiley & Sons, Inc. 1997, ISBN: 0 471 15573 X
- [59] The EMC Test Laboratories Association, www.emctla.co.uk.
- [60] *"Engineering and Design - Electromagnetic Pulse (EMP) and Tempest Protection for Facilities"*, U.S. Army Corps of Engineers, 31 December 1990, Publication Number: EP 1110-3-2, www.fas.org/nuke/intro/nuke/emp/toc.htm
- [61] International Telecommunication Union (ITU) Recommendation K.27 (1996): *"Bonding configurations and earthing within a telecommunications building"*, www.itu.int
- [62] ANSI/TIA/EIA-607 *"Telecommunication Earthing Networks"*
- [63] Visit www.cortecVpCI.com for details. The author has no direct experience of this technique and makes no claims for its effectiveness. But it looks very interesting!
- [64] *"Design Techniques for EMC- Part 4: Shielding"*, Keith Armstrong, The UK EMC Journal, March 2007 (Issue 69) pages 31-46, May 2007 (Issue 70) pages 32-46, July 2007 (Issue 71) pages 35-46, available from www.compliance-club.com (search by 'Keith Armstrong')
- [65] Laird Technologies Technical Notes, visit: <http://www.lairdtech.com/pages/catalogs/emi.asp> and scroll down the page.
- [66] *"Analysis of Electromagnetic Shielding of Cables and Connectors"*, Lothar O (Bud) Hoeft, 2002 IEEE International Symposium on EMC, Minneapolis, www.emcinfo.se/ieee/protokoll/34/EMag_Shielding_of_Cables_and_Connectors.
- [67] REO Guide to EN 55022 and 55011 (Emissions of conducted RF), from www.reo.co.uk/knowledgebase

[69] *“Design Techniques for EMC- Part 3: Filtering and Suppressing Transients”*, Keith Armstrong, The EMC Journal, September 2006 (Issue 66) pages 39-44, November 2006 (Issue 67) pages 32-46, and January 2007 (Issue 68) pages 26-38, available from www.compliance-club.com (search by ‘Keith Armstrong’)

[70] *“Choosing and Installing Mains Filters”*, Keith Armstrong and Tim Williams, Compliance Engineering magazine, January/February 2000, pages 68 – 75. Available along with some other useful articles on choosing filters via the ‘Publications and Downloads’ pages at www.cherryclough.com

[71] *“The Expanding Role of Architectural Shielding: Four Case Studies”*, Fred Helene, ITEM 1995, http://www.interferencetechnology.com/ArchivedArticles/Architectural_shielding/95Art21.htm?regid=

[72] *“Electromagnetic Interference and Compatibility, Vol. 3 of a Handbook Series on EMI Control Methods and Techniques”*, Donald R J White, published by Don White Consultants, Inc. 1973, Library of Congress Catalogue Card No. 72-138444.

[73] *“Modelling Shielding Properties of Concrete”*, Ade Ogunsola, Ugo Reggiani and Leonardo Sandrolini, 17th International Zurich Symposium on EMC, Singapore, 27 Feb - 3 Mar 2006, ISBN: 3-9522990-4-9, www.emc-zurich.org.

[74] *“Cement Based Electromagnetic Shielding and Absorbing Building Materials”*, Hongtao Guan, Shunhua Liu, Yuping Duan and Ji CHng, Cement and

Concrete Composites, Vol. 28, Iss. 5, May 2006, pp 468-474

[75] *“Research on the absorbing characteristics of cement matrix composites filled with carbon black-coated expanded polystyrene beads”*, J. Du, S. Liu and H. Guan, Advances in Cement Research, Vol. 18, No. 4, October 2006, pp 161–164.

[76] RFI Industries Pty Ltd, Australia, www.rfi-ind.com.au.

[77] *“A Guide to BS EN 62305:2006, Protection Against Lightning”*, published by Furse (a Thomas & Betts Company), Furse-SG-0407, www.furse.com

[78] *“The Development of High-Power Electromagnetic (HPEM) Publications in the IEC: History and Current Status”*, Dr. William A. Radasky, IEEE EMC Society Newsletter, Issue No. 216, Winter 2008, <http://www.ieee.org/organizations/pubs/newsletters/emcs/winter08/hpem.html>

[79] *“2007 Update on Intentional Electromagnetic Interference (IEMI) and high-altitude electromagnetic pulse (HEMP)”*, by Dr William A Radasky, Ph.D., P.E., Interference Technology’s EMC Directory & Design Guide 2007, pages 143-148, www.interferencetechnology.com.

A similar article: *“High-Altitude Electromagnetic Pulse (HEMP): A Threat to Our Way of Life”*, with more technical detail and the same list of risks as regards the US power grid, is available from: <http://www.todayseengineer.org/2007/Sep/HEMP.asp>.)

[80] *“Just a Normal Town...”*, New Scientist, July 1st 2000, pp 20-24, www.newscientist.com

[81] *“Information Warfare: Battles in Cyberspace”*, by Richard E Overill, IEE

Computing and Control Engineering Journal, June 2001, pp125 – 128, www.theiet.org.

[82] “*Fretting Corrosion in Electrical Contacts*”, E M Bock and J H Whitley, Twentieth Annual Holm Seminar on Electrical Contacts, October 29-31, 1974. Available as Tyco White Paper <http://www.tycoelectronics.com/documentation/whitepapers/pdf/p154-74.pdf>

[83] “*Role of Steel Frames of Buildings for Mitigation of Lightning-Induced Magnetic Fields*”, S Miyazaki and M Ishii, IEEE Transaction on EMC, Vol. 50, No. 2, May 2008, pp 333-339

[84] “*Gone in 90 seconds*”, One solar storm could destroy power grids all over the world, with appalling consequences, warns Michael Brooks, New Scientist, 21 March 2009, pp 31 – 35, www.newscientist.com

[85] “*Report of the Commission to Assess the Threat to the United States from Electromagnetic Pulse (EMP) Attack — Critical National Infrastructures*”, April 2008, ISBN 978-0-16-080927-9, http://www.empcommission.org/docs/A2473-EMP_Commission-7MB.pdf

[86] “*Report of the Commission to Assess the Threat to the United States from Electromagnetic Pulse (EMP) Attack — Volume 1: Executive Report*”, 2004, http://www.globalsecurity.org/wmd/library/congress/2004_r/04-07-22emp.pdf

EN and IEC standards may be purchased from British Standards Institution (BSI) at: orders@bsi-global.com. To enquire about a product or service call BSI Customer Services on +44 (0)20 8996 9001 or e-mail them at cservices@bsi-global.com.

IEC standards can also be purchased with a credit card, in English and many other languages, from <http://webstore@iec.ch>.

REO is an original manufacturer of high quality power equipment, including electronic controllers, components and electrical regulators, all backed by the application expertise demanded by specialised, industrial sectors, such as

Controllers designed specifically for use in the parts and materials handling industry, together with a wide range of electromagnets for driving vibratory feeders.

Power controllers for adjusting and regulating voltage, current, frequency or power, as well as its long established variable transformers (variacs) up to 1MVA and sliding resistors of all types. These are complemented by a range of modern, electronic, variable power supplies.

Components for adapting variable speed drives employed in non-standard applications; including inductors, EMC filters and braking resistors. The range of inductive devices extends into railway components for electrical traction and rolling stock, which includes chokes and high-frequency transformers.

Special, toroidal transformers used in safety, medical and energy-saving systems plus high-frequency transformers used in switch-mode power supplies.

Test equipment such as load banks and variable AC/DC power supplies,

REO actively searches for development partners, particularly in niche markets, and considers this to be an essential stimulus for creating new and original ideas.

Product Examples

RFI filters and line reactors up to 2000A..



REO combi filter, with integrated differential mode choke



View further products on-line @ www.reo.co.uk

My Account

REGISTER NOW

Creating an account
only takes a few moments.
Manage your orders and details.

REGISTER NOW LOGIN

REO is an original manufacturer of high quality power equipment, including electronic controllers, components and electrical regulators.



Products

Braking Resistors
Drive Products
EMC Filters
E11 Series of Guidebooks
High Power Rheostat
Medical Isolation Transformers
Special Offers
Thyristor Power Controllers
Toroidal Transformers
Varecoff SAG Softstarts
Variable Transformers
New products

5 WAYS TO PAY

Secure online
Phone: +44 (0)1588 673 411
Fax: +44 (0)1588 672 718
Cheque
Account enquiries welcome

NEED HELP?

- Use our new partfinder service
- Phone: +44(0)1588 673 411
- Send us an email

The REO Online shop provides an easy way for all of our customers to purchase our high quality products.

New products are added all the time, so check back regularly. If you want to be updated automatically [sign-up for our email newsletter](#)

Choose from one of our product ranges below:



Braking Resistor



Drive Products



EMC Filters



E11 Series of Guidebooks



High Power Rheostat



Medical Isolation Transformers



Special Offers



Thyristor Power Controllers



Toroidal Transformers



Varecoff SAG Softstarts



Variable Transformers

Free delivery on all orders over £500

We offer a 7 day money back guarantee

Try our Partfinder Service

Delivery from stock

Competitive pricing

Fast technical response

The best possible service.



Keith Armstrong from Cherry Clough Consultants

Keith Armstrong graduated in electrical engineering with a B.Sc (Hons.) from Imperial College London in 1972, majoring in analogue circuit design and electromagnetic field theory, with a Upper Second Class Honours (Cum Laude). Much of his life since then has involved controlling real-life interference problems in high-technology products, systems, and installations, for a variety of companies and organisations in a range of industries.

Keith has been a Chartered Electrical Engineer (UK) since 1978, a Group 1 European Engineer since 1988, and has written and presented a great many papers and articles on EMC. He is a

past chairman of the IEE's Professional Group (E2) on Electromagnetic Compatibility, is a member of the IEEE's EMC Society, the EMC Test Labs Association [59], the EMC Industries Association (www.emcia.org), and chairs the IEE's Working Group on 'EMC and Functional Safety'.

Contact: Keith Armstrong by email at keith.armstrong@cherryclough.com or visit the Cherry Clough website www.cherryclough.com.

See www.reo.co.uk/ guides for many other practical guides, similar to this one, relating to Electromagnetic (EM) phenomena.

If you would like to be kept informed about new guides as soon as they become available, then all you have to do is sign up as a member by going to www.reo.co.uk/ members



Train Systems

Chokes and high frequency transformers



Inductive Components

Chokes, resistors and transformers

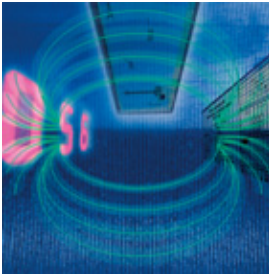

Test Systems

Power supplies and load banks



Power Electronics

Phase-angle and frequency controllers



Drive Systems

Filters and braking resistors



Medical Systems

Medical Transformers



Automation Systems

Controllers for vibratory feeders

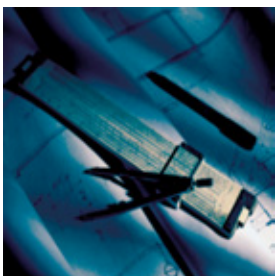

Classics

Rheostats and variacs

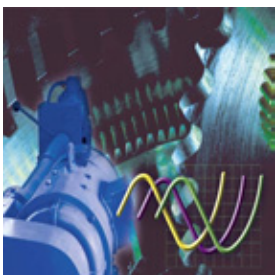

Motor Control Systems

Soft-starts



Communication Systems

Field bus and gsm



Renewable Systems

Solar transformers



REO

REO (UK) LTD, Units 2 - 4 Callow Hill Road, Craven Arms
Business Park, Craven Arms, Shropshire SY7 8NT UK
Tel: 01588 673411 Fax: 01588 672718
Email: sales@reo.co.uk Website: www.reo.co.uk